

TROUBLESHOOTING MANUAL

INDUSTRIAL ENGINE

TNV, TN

3TNV88C

3TN88C

3TNV86CT

3TN86CT

4TNV88C

4TN88C

4TNV86CT

4TN86CT

4TNV98C

4TN98C

4TNV98CT

4TN98CT

YANMAR

**California
Proposition 65 Warning**

Diesel engine exhaust and some of its constituents are known to the state of California to cause cancer, birth defects, and other reproductive harm.

Disclaimers:

All information, illustrations and specifications in this manual are based on the latest information available at the time of publishing. The illustrations used in this manual are intended as representative reference views only. Moreover, because of our continuous product improvement policy, we may modify information, illustrations and/or specifications to explain and/or exemplify a product, service or maintenance improvement. We reserve the right to make any change at any time without notice. YANMAR is a registered trademark of YANMAR POWER TECHNOLOGY CO., LTD. in Japan, the United States and/or other countries.

All Rights Reserved:

No part of this publication may be reproduced or used in any form by any means - graphic, electronic, or mechanical, including photocopying, recording, taping, or information storage and retrieval systems - without the written permission of YANMAR POWER TECHNOLOGY CO., LTD.

In case of exporting this product and providing the related technical material to non-residents in Japan or residents overseas, it is required to comply with the export and trade control laws and regulations of Japan and other relevant countries.
Please be sure to follow the necessary procedure.

TROUBLESHOOTING MANUAL	MODEL	3TNV88C, 3TNV86CT, 4TNV88C, 4TNV86CT, 4TNV98C, 4TNV98CT, 3TN88C, 3TN86CT, 4TN88C, 4TN86CT, 4TN98C, 4TN98CT
	CODE	0DTN5-EN1023

CONTENTS

1. DTC (Diagnostic Trouble Codes) General Description	1
DTC code list	1
Additional requirements for EU Stage V (less than 56 kW) regulations	6
Power restrictions due to inducement when NCD abnormality occurs	6
How to clear the error subject to inducement (NCD error) display	7
Description	8
Sensor related	9
Crankshaft speed sensor	9
P0336: Crankshaft signal error	9
P0337: No signal from crankshaft	11
Camshaft speed sensor	13
P0341: Camshaft signal error	13
P0342: No signal from camshaft	15
P1341: Angle offset error	17
P0008: No signal on both crankshaft and camshaft speed sensor	19
Accelerator sensor	20
P0123: Accelerator sensor 1 error (voltage high)	20
P0122: Accelerator sensor 1 error (voltage low)	22
P0223: Accelerator sensor 2 error (voltage high)	24
P0222: Accelerator sensor 2 error (voltage low)	26
P1646: Dual accelerator sensor error (closed position)	28
P1647: Dual accelerator sensor error (open position)	30
P0228: Accelerator sensor 3 error (voltage high)	32
P0227: Accelerator sensor 3 error (voltage low)	34
P1227: Pulse accelerator sensor error (pulse communication)	36
P1126: Accelerator sensor 3 error (foot pedal in open position)	37
P1125: Accelerator sensor 3 error (foot pedal in closed position)	39
Intake throttle position sensor	40
P02E9: Intake throttle position sensor error (voltage high)	40
P02E8: Intake throttle position sensor error (voltage low)	42
EGR low pressure side pressure sensor	44
P0238: EGR low pressure side pressure sensor error (voltage high)	44
P0237: EGR low pressure side pressure sensor error (voltage low)	46
P0236: EGR low pressure side pressure sensor error (abnormal learning value)	48
P1673: EGR low pressure side pressure sensor error (detected value error)	50
EGR high pressure side pressure sensor	52
P0473: EGR high pressure side pressure sensor error (voltage high)	52
P0472: EGR high pressure side pressure sensor error (voltage low)	54
P0471: EGR high pressure side pressure sensor error (abnormal learning value)	56
P1679: EGR high pressure side pressure sensor error (detected value error)	58
Engine coolant temperature sensor	60
P0118: Engine coolant temperature sensor error (voltage high)	60
P0117: Engine coolant temperature sensor error (voltage low)	62
P1674: Engine coolant temperature sensor error (detected value error)	64
P0217: Engine coolant temperature high (overheat)	66

Ambient air temperature sensor	68
P0113: Ambient air temperature sensor error (voltage high)	68
P0112: Ambient air temperature sensor error (voltage low).....	70
Fuel temperature sensor	72
P0183: Fuel temperature sensor error (voltage high)	72
P0182: Fuel temperature sensor error (voltage low).....	74
P0168: Fuel temperature high	76
Rail pressure sensor	78
P0193: Rail pressure sensor error (voltage high)	78
P0192: Rail pressure sensor error (voltage low)	80
DPF differential pressure sensor	82
P2455: DPF differential pressure sensor error (voltage high)	82
P2454: DPF differential pressure sensor error (voltage low)	84
P2452: DPF differential pressure sensor differential pressure rise error	86
P2453: DPF differential pressure sensor error (abnormal learning value).....	88
DPF substrate/DPF differential pressure sensor	90
P226D: DPF substrate/DPF differential pressure sensor error (DPF substrate removal/DPF differential pressure sensor detected value error).....	90
DPF high pressure side pressure sensor	92
P1455: DPF high pressure side pressure sensor error (voltage high)	92
P1454: DPF high pressure side pressure sensor error (voltage low).....	94
P167C: DPF high pressure side pressure sensor error (detected value error).....	96
DPF inlet temperature sensor	98
P1428: DPF inlet temperature sensor error (voltage high)	98
P1427: DPF inlet temperature sensor error (voltage low).....	100
P167E: DPF inlet temperature sensor error (detected value error).....	102
P1436: DPF inlet temperature sensor error (high temperature)	104
DPF intermediate temperature sensor	105
P1434: DPF intermediate temperature sensor error (voltage high)	105
P1435: DPF intermediate temperature sensor error (voltage low)	107
P167A: DPF intermediate temperature sensor error (detected value error)	109
P0420: DPF intermediate temperature sensor temperature too low	111
Atmospheric pressure sensor	112
P2229: Atmospheric pressure sensor error (voltage high)	112
P2228: Atmospheric pressure sensor error (voltage low).....	113
P2226: Atmospheric pressure sensor error (Digital IC error)	114
P1231: Atmospheric pressure sensor error (characteristic error)	115
EGR gas temperature sensor	117
P041D: EGR gas temperature sensor error (voltage high)	117
P041C: EGR gas temperature sensor error (voltage low)	119
P1675: EGR gas temperature sensor error (detected value error).....	121
Intake manifold temperature sensor	123
P040D: Intake manifold temperature sensor error (voltage high)	123
P040C: Intake manifold temperature sensor error (voltage low).....	125
P1676: Intake manifold temperature sensor error (detected value error)	127
Exhaust manifold temperature sensor	129
P0546: Exhaust manifold temperature sensor error (voltage high).....	129
P0545: Exhaust manifold temperature sensor error (voltage low)	131
P1677: Exhaust manifold temperature sensor error (detected value error)	133

Contact output related	135
Main relay	135
P068B: Main relay contact sticking	135
P068A: Main relay early opening	137
Starting aid relay	139
P0543: Starting aid relay disconnection	139
P0541: Starting aid relay GND short circuit	141
CRS (common rail system) related	143
Injector (No. 1 cylinder)	143
P0201: Injector (No. 1 cylinder) disconnection (injector-specific)	143
P0262: Injector (No. 1 cylinder) coil short circuit	145
P1262: Injector (No. 1 cylinder) short circuit	147
Injector (No. 2 cylinder)	149
P0202: Injector (No. 2 cylinder) disconnection (injector-specific)	149
P0265: Injector (No. 2 cylinder) coil short circuit	151
P1265: Injector (No. 2 cylinder) short circuit	153
Injector (No. 3 cylinder)	155
P0203: Injector (No. 3 cylinder) disconnection (injector-specific)	155
P0268: Injector (No. 3 cylinder) coil short circuit	157
P1268: Injector (No. 3 cylinder) short circuit	159
Injector (No. 4 cylinder)	161
P0204: Injector (No. 4 cylinder) disconnection (injector-specific)	161
P0271: Injector (No. 4 cylinder) coil short circuit	163
P1271: Injector (No. 4 cylinder) short circuit	165
All injectors	167
P0611: Injector drive IC error	167
P1146: Injector drive circuit (Bank 1) short circuit	168
P1149: Injector drive circuit (Bank 2) short circuit	170
P1648: Injector (No. 1 cylinder) correction value error	172
P1649: Injector (No. 2 cylinder) correction value error	173
P1650: Injector (No. 3 cylinder) correction value error	174
P1651: Injector (No. 4 cylinder) correction value error	175
SCV (MPROP)	176
P1641: SCV (MPROP) L side VB short circuit	176
P1643: SCV (MPROP) L side GND short circuit	177
P0629: SCV (MPROP) H side VB short circuit	179
P1642: SCV (MPROP) H side GND short circuit	181
P064A: SCV (MPROP) H side - L side short circuit	182
P0627: SCV (MPROP) disconnection	183
P025B: SCV (MPROP) failure diagnosis information not received	184
P062A: SCV (MPROP) drive current (high level)	185
P1645: SCV (MPROP) pump overload error	187
Rail pressure error	189
P0088: Rail pressure too high	189
P0094: Rail pressure deviation error (low rail pressure)	191
P0093: Rail pressure deviation error (high rail pressure)	193
PLV (Common rail pressure limit valve)	195
P000F: PLV open valve	195
P1666: Rail pressure fault (The times of PLV valve opening error)	197
P1667: Rail pressure fault (The time of PLV valve opening error)	199
P1668: Rail pressure fault	
(The actual rail pressure is too high during PRV limp home)	201
P1665: Rail pressure fault (Controlled rail pressure error after PLV valve opening)	203

Rail pressure control	205
P1669: Rail pressure fault (Injector B/F temperature error during PLV4 limp home)	205
P1670: Rail pressure fault (Operation time error during RPS limp home)	207
Actuator	208
Intake throttle drive circuit	208
P0660: No-load of throttle valve drive H bridge circuit	208
P1658: Power short circuit of throttle valve drive H bridge output 1	209
P1659: GND short circuit of throttle valve drive H bridge output 1	210
P1660: Overload on the drive H bridge circuit of throttle valve	211
P1661: VB Power short circuit of throttle valve drive H bridge output 2	212
P1662: GND short circuit of throttle valve drive H bridge output 2	213
P02E4: Throttle valve sticking (sticking open)	214
P02E5: Throttle valve sticking (sticking closed)	216
EGR	218
P0404: EGR overvoltage error	218
P1404: EGR low voltage error	220
P1409: EGR feedback error	222
U0401: EGR ECM data error	223
P0403: Disconnection in EGR motor coils	225
P1405: Short circuit in EGR motor coils	226
P0488: EGR position sensor error	227
P148A: EGR valve sticking error	228
P049D: EGR initialization error	229
U1401: EGR target value out of range	230
P1410: EGR high temperature thermistor error	231
P1411: EGR low temperature thermistor error	232
Exhaust throttle	233
P1438: Exhaust throttle (voltage fault)	233
P1439: Exhaust throttle (motor fault)	234
P1440: Exhaust throttle (sensor system fault)	235
P1441: Exhaust throttle (MPU fault)	236
P1442: Exhaust throttle (PCB fault)	237
P1443: Exhaust throttle (CAN fault)	238
Communication related	239
CAN 1	239
U010B: CAN 1 (for EGR): Reception time out	239
U1107: CAN 1 (for exhaust throttle): Reception time out	241
CAN 2	242
U0292: TSC1 (SA1) reception timeout	242
U1301: TSC1 (SA2) reception timeout	244
U1292: Y_ECR1 reception timeout	246
U1293: Y_EC reception timeout	248
U1294: Y_RSS reception timeout	250
U0168: VI reception timeout	252
U3002: VI reception data error	253
U1300: Y_ETCP1 reception time out	254
U1302: EBC1 reception timeout	256
U1303: Y_DPFIF reception timeout	258
U0167: Immobilizer error (CAN communication)	260
U0426: Immobilizer error (system)	261

ECU related	262
EEPROM	262
P0601: EEPROM memory deletion error	262
P160E: EEPROM memory reading error	263
P160F: EEPROM memory writing error	264
ECU internal fault	265
P1613: CY146 SPI communication fault	265
P1608: Excessive voltage of supply 1	266
P1617: Insufficient voltage of supply 1	267
P1031: Shutoff 1 due to ECU internal abnormality	268
P1032: Shutoff 2 due to ECU internal abnormality	269
P1033: Shutoff 3 due to ECU internal abnormality	270
P1034: Shutoff 4 due to ECU internal abnormality	271
P1609: Sensor supply voltage error 1	272
P1618: Sensor supply voltage error 2	273
P1619: Sensor supply voltage error 3	274
P1689: Sensor supply voltage error 4	275
P1626: Actuator drive circuit 1 short to ground	276
P1633: Actuator drive circuit 2 short to ground	277
P1467: Actuator drive circuit 3 short to ground	278
P1469: AD converter fault 1	279
P1470: AD converter fault 2	280
P1471: External monitoring IC and CPU fault 1	281
P1472: External monitoring IC and CPU fault 2	282
P1473: ROM fault	283
P1474: Shutoff path fault 1	284
P1475: Shutoff path fault 2	285
P1476: Shutoff path fault 3	286
P1477: Shutoff path fault 4	287
P1478: Shutoff path fault 5	288
P1479: Shutoff path fault 6	289
P1480: Shutoff path fault 7	290
P1481: Shutoff path fault 8	291
P1482: Shutoff path fault 9	292
P1483: Shutoff path fault 10	293
P1035: Shut-off path abnormality by external monitoring IC and CPU	294
P1484: Recognition error of engine speed	295
Contact output related	296
Breather heater (Optional parts for 4TNV86CT and 4TNV98CT)	296
P053A: Breather heater disconnection	296
P053B: Breather heater short circuit (GND)	297
P053C: Breather heater short circuit (VB)	298
Contact input related	299
Air cleaner switch	299
P1101: Air cleaner clogged alarm	299
Water separator switch	301
P1151: Water separator alarm	301
Charge switch	303
P1562: Charge switch open circuit	303
P1568: Charge alarm	305
Oil pressure switch	307
P1192: Oil pressure switch open circuit	307
P1198: Low oil pressure fault alarm	309

After treatment control	311
DPF	311
P2463: Excessive PM accumulation (method C)	311
P1463: Excessive PM accumulation (method P)	312
P2458: Regeneration failure (stationary regeneration failure)	313
P2459: Regeneration failure (stationary regeneration not performed)	314
P1426: DPF intermediate temperature sensor temperature rise error (post-injection failure)	315
DPF OP interface	316
P242F: Ash cleaning request 1	316
P1420: Ash cleaning request 2	317
P1421: Stationary regeneration standby	318
P1424: Backup mode	319
P1425: Reset regeneration is inhibited	320
P1445: Recovery regeneration failure	321
P1446: Recovery regeneration is inhibited	322
Others	323
Overspeed	323
P0219: Overspeed	323
2. Method and Procedure of Failure Diagnosis	324
Description	324
ECU pin layout diagram	325
How to use the Tier 4 checker harness	327
Sensor related	328
Crankshaft speed sensor	328
Camshaft speed sensor	331
Accelerator sensor	334
Intake throttle position sensor	337
EGR low pressure side pressure sensor	340
EGR high pressure side pressure sensor	348
Engine coolant temperature sensor	351
Ambient air temperature sensor	360
Fuel temperature sensor	364
Rail pressure sensor	368
DPF differential pressure sensor	371
DPF inlet temperature sensor	374
DPF intermediate temperature sensor	378
EGR gas temperature sensor	382
Intake manifold temperature sensor	391
Exhaust manifold temperature sensor	400
Contact output related	409
Main relay	409
Starting aid relay (Glow relay)	413
Breather heater (Optional parts for 4TNV86CT and 4TNV98CT)	417

Contact input related	421
Contact input related 1	421
Contact input related 2	424
Post treatment related	427
DPF OP interface	427
Ash cleaning request	427
Stationary regeneration standby	428
Recovery regeneration is inhibited	429
Backup mode	430
DPF	431
Excessive PM accumulation	431
Regeneration failure 1	434
Regeneration failure 2	437
CRS (common rail system) related	440
Injector	440
Disconnection of the injector and coil short circuit	440
Injector short circuit	445
High-pressure pump (MPROP)	447
Actuator	449
Intake throttle drive circuit	449
Intake throttle	453
EGR valve	459
EGR valve	463
Communication related	464
CAN 1	464
CAN 2	467
ECU related	470
Others	472
Overspeed	472

TROUBLESHOOTING

Although BOSCH ECU (EDC17) is used for TNV and TN series engines, BOSCH ECU (MD1) is used for some TN series engines. In order to distinguish, the adopted engine of BOSCH ECU (MD1) is named TN OO - numbers (1 to 6). Where identification is required, the ECU model is indicated in parentheses after the engine model.

DTC (Diagnostic Trouble Codes) General Description

DTC code list

DTC code					Error		ECU type		Reference page		
P code	SPN		FMI	Lamp that comes on (Tier4)	Lamp that comes on (Stage V)	Part	State	EDC 17	MD1	Description	Diagnosis
	Decima number	Hexa-decimal number									
P0336	522400	7F8A0	2	FAIL + AWL	FAIL + AWL	Crankshaft speed sensor	Crankshaft signal error	●	●	P9	P328
P0337			5	FAIL + AWL	FAIL + AWL		No signal from crankshaft	●	●	P11	P328
P0341	522401	7F8A1	2	FAIL + AWL	FAIL + AWL	Camshaft speed sensor	Camshaft signal error	●	●	P13	P331
P0342			5	FAIL + AWL	FAIL + AWL		No signal from camshaft	●	●	P15	P331
P1341			7	FAIL + AWL	FAIL + AWL		Angle offset error	●	●	P17	–
P0008	523249	7FBF1	5	FAIL + RSL	FAIL + RSL	Crankshaft speed sensor, Camshaft speed sensor	No signal on both crankshaft and camshaft speed sensor	●	●	P19	P328, P331
P0123	91	5B	3	FAIL + AWL	FAIL + AWL	Accelerator sensor 1	Accelerator sensor 1 error (voltage high)	●	●	P20	P334
P0122			4	FAIL + AWL	FAIL + AWL		Accelerator sensor 1 error (voltage low)	●	●	P22	P334
P0223	28	1C	3	FAIL + AWL	FAIL + AWL	Accelerator sensor 2	Accelerator sensor 2 error (voltage high)	●	●	P24	P334
P0222			4	FAIL + AWL	FAIL + AWL		Accelerator sensor 2 error (voltage low)	●	●	P26	P334
P1646	522624	7F980	7	FAIL + AWL	FAIL + AWL	Accelerator sensor 1 + 2	Dual accelerator sensor error (closed position)	●	●	P28	–
P1647	522623	7F97F	7	FAIL + AWL	FAIL + AWL		Dual accelerator sensor error (open position)	●	●	P30	–
P0228	29	1D	3	FAIL + AWL	FAIL + AWL	Accelerator sensor 3	Accelerator sensor 3 error (voltage high)	●	●	P32	P334
P0227			4	FAIL + AWL	FAIL + AWL		Accelerator sensor 3 error (voltage low)	●	●	P34	P334
P1227			8	FAIL + AWL	FAIL + AWL	Pulse sensor	Pulse accelerator sensor error (pulse communication)	●	●	P36	–
P1126	28	1C	0	FAIL + AWL	FAIL + AWL	Accelerator sensor 3	Accelerator sensor 3 error (foot pedal in open position)	●	●	P37	–
P1125			1	FAIL + AWL	FAIL + AWL		Accelerator sensor 3 error (foot pedal in closed position)	●	●	P39	–
P02E9	51	33	3	FAIL + RSL	FAIL + RSL	Intake throttle position sensor	Intake throttle position sensor error (voltage high)	●	●	P40	P337
P02E8			4	FAIL + RSL	FAIL + RSL		Intake throttle position sensor error (voltage low)	●	●	P42	P337
P0238	102	66	3	FAIL + RSL	FAIL + RSL	EGR low pressure side pressure sensor	EGR low pressure side pressure sensor error (voltage high)	●	●	P44	P340
P0237			4	FAIL + RSL	FAIL + RSL		EGR low pressure side pressure sensor error (voltage low)	●	●	P46	P340
P0236			13	FAIL + RSL	FAIL + RSL		EGR low pressure side pressure sensor error (abnormal learning value)	●	●	P48	P340
P1673			10	FAIL + RSL	FAIL + RSL		EGR low pressure side pressure sensor error (detected value error)	●	●	P50	P343
P0473	1209	4B9	3	FAIL + RSL	FAIL + RSL	EGR high pressure side pressure sensor	EGR high pressure side pressure sensor error (voltage high)	●	●	P52	P348
P0472			4	FAIL + RSL	FAIL + RSL		EGR high pressure side pressure sensor error (voltage low)	●	●	P54	P348
P0471			13	FAIL + RSL	FAIL + RSL		EGR high pressure side pressure sensor error (abnormal learning value)	●	●	P56	P348
P1679			10	FAIL + RSL	FAIL + RSL		EGR high pressure side pressure sensor error (detected value error)	●	●	P58	P348
P0118	110	6E	3	FAIL + AWL	FAIL + RSL	Engine coolant temperature sensor	Engine coolant temperature sensor error (voltage high)	●	●	P60	P351
P0117			4	FAIL + AWL	FAIL + RSL		Engine coolant temperature sensor error (voltage low)	●	●	P62	P351
P1674			10	–	FAIL + RSL		Engine coolant temperature sensor error (detected value error)	●	●	P64	P355
P0217			0	Application specific	Application specific		Engine coolant temperature high (overheat)	●	●	P66	P351

DTC (Diagnostic Trouble Codes) General Description

P code	DTC code			Lamp that comes on (Tier4)	Lamp that comes on (Stage V)	Error		ECU type		Reference page	
	SPN		FMI			Part	State	EDC 17	MD1	Description	Diagnosis
	Decima number	Hexa-decimal number	Decima number								
P0113	172	AC	3	FAIL + AWL	FAIL + AWL	Ambient air temperature sensor	Ambient air temperature sensor error (voltage high)	●	●	P68	P360
P0112			4	FAIL + AWL	FAIL + AWL		Ambient air temperature sensor error (voltage low)	●	●	P70	P360
P0183	174	AE	3	FAIL + AWL	FAIL + AWL	Fuel temperature sensor	Fuel temperature sensor error (voltage high)	●	●	P72	P364
P0182			4	FAIL + AWL	FAIL + AWL		Fuel temperature sensor error (voltage low)	●	●	P74	P364
P0168			0	Application specific	Application specific		Fuel temperature high	●	●	P76	P364
P0193	157	9D	3	FAIL + RSL	FAIL + RSL	Rail pressure sensor	Rail pressure sensor error (voltage high)	●	●	P78	P368
P0192			4	FAIL + RSL	FAIL + RSL		Rail pressure sensor error (voltage low)	●	●	P80	P368
P2455	3251	CB3	3	FAIL + RSL	FAIL + RSL	DPF differential pressure sensor	DPF differential pressure sensor error (voltage high)	●	●	P82	P371
P2454			4	FAIL + RSL	FAIL + RSL		DPF differential pressure sensor error (voltage low)	●	●	P84	P371
P2452			0	FAIL + RSL	FAIL + RSL		DPF differential pressure sensor differential pressure rise error	●	●	P86	P371
P2453			13	FAIL + RSL	FAIL + RSL		DPF differential pressure sensor error (abnormal learning value)	●	●	P88	P371
P226D	4795	12BB	31	FAIL + AWL	FAIL + AWL	DPF substrate/DPF differential pressure sensor	DPF substrate/DPF differential pressure sensor error (DPF substrate removal/DPF differential pressure sensor detected value error)	●	●	P90	P371
P1455	3609	E19	3	FAIL + RSL	FAIL + RSL	DPF high pressure side pressure sensor	DPF high pressure side pressure sensor error (voltage high)	●	●	P92	P371
P1454			4	FAIL + RSL	FAIL + RSL		DPF high pressure side pressure sensor error (voltage low)	●	●	P94	P371
P167C			10	FAIL + AWL	FAIL + AWL		DPF high pressure side pressure sensor error (detected value error)	●	●	P96	P371
P1428	3242	CAA	3	FAIL + RSL	FAIL + RSL	DPF inlet temperature sensor	DPF inlet temperature sensor error (voltage high)	●	●	P98	P374
P1427			4	FAIL + RSL	FAIL + RSL		DPF inlet temperature sensor error (voltage low)	●	●	P100	P374
P167E			10	FAIL + AWL	FAIL + AWL		DPF inlet temperature sensor error (detected value error)	●	●	P102	P374
P1436			0	FAIL + AWL	FAIL + AWL		DPF inlet temperature sensor error (high temperature)	●	●	P104	P374
P1434	3250	CB2	3	FAIL + RSL	FAIL + RSL	DPF intermediate temperature sensor	DPF intermediate temperature sensor error (voltage high)	●	●	P105	P378
P1435			4	FAIL + RSL	FAIL + RSL		DPF intermediate temperature sensor error (voltage low)	●	●	P107	P378
P167A			10	FAIL + AWL	FAIL + AWL		DPF intermediate temperature sensor error (detected value error)	●	●	P109	P378
P0420			1	FAIL + AWL	FAIL + AWL		DPF intermediate temperature sensor temperature too low	●	●	P111	P378
P2229	108	6C	3	FAIL + AWL	FAIL + RSL	Atmospheric pressure sensor	Atmospheric pressure sensor error (voltage high)	●	●	P112	P470
P2228			4	FAIL + AWL	FAIL + RSL		Atmospheric pressure sensor error (voltage low)	●	●	P113	P470
P2226			12	FAIL + AWL	FAIL + RSL		Atmospheric pressure sensor error (Digital IC error)	-	●	P114	P470
P1231			10	-	FAIL + RSL		Atmospheric pressure sensor error (characteristic error)	●	●	P115	P470
P041D	412	19C	3	FAIL + AWL	FAIL + RSL	EGR gas temperature sensor	EGR gas temperature sensor error (voltage high)	●	●	P117	P382
P041C			4	FAIL + AWL	FAIL + RSL		EGR gas temperature sensor error (voltage low)	●	●	P119	P382
P1675			10	-	FAIL + RSL		EGR gas temperature sensor error (detected value error)	●	●	P121	P386
P040D	105	69	3	FAIL + RSL	FAIL + RSL	Intake manifold temperature sensor	Intake manifold temperature sensor error (voltage high)	●	●	P123	P391
P040C			4	FAIL + RSL	FAIL + RSL		Intake manifold temperature sensor error (voltage low)	●	●	P125	P391
P1676			10	FAIL + RSL	FAIL + RSL		Intake manifold temperature sensor error (detected value error)	●	●	P127	P395
P0546	173	AD	3	FAIL + AWL	FAIL + RSL	Exhaust manifold temperature sensor	Exhaust manifold temperature sensor error (voltage high)	●	●	P129	P400
P0545			4	FAIL + AWL	FAIL + RSL		Exhaust manifold temperature sensor error (voltage low)	●	●	P131	P400
P1677			10	-	FAIL + RSL		Exhaust manifold temperature sensor error (detected value error)	●	●	P133	P404
P068B	1485	5CD	7	FAIL + AWL	FAIL + AWL	Main relay	Main relay contact sticking	●	●	P135	P409
P068A			2	FAIL + AWL	FAIL + AWL		Main relay early opening	●	●	P137	P409
P0543	522243	7F803	5	FAIL + AWL	FAIL + AWL	Starting aid relay	Starting aid relay disconnection	●	●	P139	P413
P0541			6	FAIL + AWL	FAIL + AWL		Starting aid relay GND short circuit	●	●	P141	P413
P0201	654	28E	5	FAIL + RSL	FAIL + RSL	Injector (No. 1 cylinder)	Disconnection (injector-specific)	●	●	P143	P440
P0262			6	FAIL + RSL	FAIL + RSL		Coil short circuit	●	●	P145	P440
P1262			3	FAIL + RSL	FAIL + RSL		Short circuit	●	●	P147	P445

DTC (Diagnostic Trouble Codes) General Description

P code	DTC code			Lamp that comes on (Tier4)	Lamp that comes on (Stage V)	Part	Error	ECU type		Reference page			
	SPN		FMI					EDC 17	MD1	Description	Diagnosis		
	Decima number	Hexa-decimal number	Decima number										
P0202	653	28D	5	FAIL + RSL	FAIL + RSL	Injector (No. 2 cylinder)	Disconnection (injector-specific)	●	●	P149	P440		
P0265			6	FAIL + RSL	FAIL + RSL		Coil short circuit	●	●	P151	P440		
P1265			3	FAIL + RSL	FAIL + RSL		Short circuit	●	●	P153	P445		
P0203	652	28C	5	FAIL + RSL	FAIL + RSL	Injector (No. 3 cylinder)	Disconnection (injector-specific)	●	●	P155	P440		
P0268			6	FAIL + RSL	FAIL + RSL		Coil short circuit	●	●	P157	P440		
P1268			3	FAIL + RSL	FAIL + RSL		Short circuit	●	●	P159	P445		
P0204	651	28B	5	FAIL + RSL	FAIL + RSL	Injector (No. 4 cylinder)	Disconnection (injector-specific)	●	●	P161	P440		
P0271			6	FAIL + RSL	FAIL + RSL		Coil short circuit	●	●	P163	P440		
P1271			3	FAIL + RSL	FAIL + RSL		Short circuit	●	●	P165	P445		
P0611	4257	10A1	12	FAIL + RSL	FAIL + RSL	All injectors	Injector drive IC error	●	●	P167	-		
P1146	2797	AED	6	FAIL + RSL	FAIL + RSL		Injector drive circuit (Bank 1) short circuit (4TN: Common circuit for No. 1, No. 4 and all 3TN cylinders)	●	●	P168	P445		
P1149	2798	AEE	6	FAIL + RSL	FAIL + RSL		Injector drive circuit (Bank 2) short circuit (4TN: Circuit for No. 2 and No. 3 cylinders)	●	●	P170	P445		
P1648	523462	7FCC6	13	FAIL + RSL	FAIL + RSL	Injector (correction value)	Injector (No. 1 cylinder) correction value error	●	●	P172	-		
P1649	523463	7FCC7	13	FAIL + RSL	FAIL + RSL		Injector (No. 2 cylinder) correction value error	●	●	P173	-		
P1650	523464	7FCC8	13	FAIL + RSL	FAIL + RSL		Injector (No. 3 cylinder) correction value error	●	●	P174	-		
P1651	523465	7FCC9	13	FAIL + RSL	FAIL + RSL		Injector (No. 4 cylinder) correction value error	●	●	P175	-		
P1641	522571	7F94B	3	FAIL + RSL	FAIL + RSL	SCV (MPROP)	SCV (MPROP) L side VB short circuit	●	●	P176	P447		
P1643			6	FAIL + RSL	FAIL + RSL		SCV (MPROP) L side GND short circuit	●	●	P177	P447		
P0629	633	279	3	FAIL + RSL	FAIL + RSL		SCV (MPROP) H side VB short circuit	●	●	P179	P447		
P1642			6	FAIL + RSL	FAIL + RSL		SCV (MPROP) H side GND short circuit	●	●	P181	P447		
P064A			2	FAIL + RSL	FAIL + RSL		SCV (MPROP) H side - L side short circuit	-	●	P182	P447		
P0627			5	FAIL + RSL	FAIL + RSL		SCV (MPROP) disconnection	●	●	P183	P447		
P025B			11	FAIL + RSL	FAIL + RSL		SCV (MPROP) failure diagnosis information not received	-	●	P184	P447		
P062A			522572	7F94C	6		FAIL + RSL	FAIL + RSL	SCV (MPROP) drive current (high level)	●	-	P185	P447
P1645	11	FAIL + RSL	FAIL + RSL	SCV (MPROP) pump overload error	●		-	P187	P447				
P0088	157	9D	0	FAIL + RSL	FAIL + RSL		Rail pressure error	Rail pressure too high	●	●	P189	-	
P0094			18	FAIL + RSL	FAIL + RSL	Rail pressure deviation error (low rail pressure)		●	●	P191	-		
P0093			15	FAIL + RSL	FAIL + RSL	Rail pressure deviation error (high rail pressure)		●	●	P193	-		
P000F			16	FAIL + RSL	FAIL + RSL	PLV open valve		●	●	P195	-		
P1666	523469	7FCCD	0	FAIL + RSL	FAIL + RSL	PLV (Common rail pressure limit valve)	Rail pressure fault (The times of PLV valve opening error)	●	●	P197	-		
P1667	523470	7FCCE	0	FAIL + RSL	FAIL + RSL		Rail pressure fault (The time of PLV valve opening error)	●	●	P199	-		
P1668	523489	7FCE1	0	FAIL + RSL	FAIL + RSL		Rail pressure fault (The actual rail pressure is too high during PRV limp home)	●	●	P201	-		
P1665	523468	7FCCC	9	FAIL + RSL	FAIL + RSL		Rail pressure fault (Controlled rail pressure error after PLV valve opening)	●	●	P203	-		
P1669	523491	7FCE3	0	FAIL + RSL	FAIL + RSL	Rail pressure control	Rail pressure fault (Injector B/F temperature error during PLV4 limp home)	●	●	P205	-		
P1670	523460	7FCC4	7	FAIL + RSL	FAIL + RSL		Rail pressure fault (Operation time error during RPS limp home)	●	●	P207	-		
P0219	190	BE	16	FAIL + RSL	FAIL + RSL	Overspeed	Overspeed	●	●	P323	P472		
P0660	2950	B86	5	FAIL + AWL	FAIL + AWL	Intake throttle drive circuit	No-load of throttle valve drive H bridge circuit	●	●	P208	P449		
P1658			3	FAIL + AWL	FAIL + AWL		Power short circuit of throttle valve drive H bridge output 1	●	●	P209	P449		
P1659			4	FAIL + AWL	FAIL + AWL		GND short circuit of throttle valve drive H bridge output 1	●	●	P210	P449		
P1660			6	FAIL + AWL	FAIL + AWL		Overload on the drive H bridge circuit of throttle valve	●	●	P211	P449		
P1661			2951	B87	3		FAIL + AWL	FAIL + AWL	VB Power short circuit of throttle valve drive H bridge output 2	●	●	P212	P449
P1662					4		FAIL + AWL	FAIL + AWL	GND short circuit of throttle valve drive H bridge output 2	●	●	P213	P449
P02E4	2950	B86	7	FAIL + RSL	FAIL + RSL	Throttle valve sticking (sticking open)	●	●	P214	P453			
P02E5	2951	B87	7	FAIL + RSL	FAIL + RSL	Throttle valve sticking (sticking closed)	●	●	P216	P453			

DTC (Diagnostic Trouble Codes) General Description

P code	DTC code			Lamp that comes on (Tier4)	Lamp that comes on (Stage V)	Error	ECU type		Reference page			
	SPN		FMI				Part	State	EDC 17	MD1	Description	Diagnosis
	Decima number	Hexa-decimal number	Decima number									
U0292	522596	7F964	9	FAIL + AWL	FAIL + AWL	CAN 2	●	●	P242	P467		
U1301	522597	7F965	9	FAIL + AWL	FAIL + AWL		TSC1 (SA2) reception timeout	●	●	P244	P467	
U1292	522599	7F967	9	FAIL + AWL	FAIL + AWL		Y_ECR1 reception timeout	●	●	P246	P467	
U1293	522600	7F968	9	FAIL + AWL	FAIL + AWL		Y_EC reception timeout	●	●	P248	P467	
U1294	522601	7F969	9	FAIL + AWL	FAIL + AWL		Y_RSS reception timeout	●	●	P250	P467	
U0168	237	ED	31	FAIL + AWL	FAIL + AWL		VI reception timeout	●	●	P252	P467	
U3002			13	FAIL + AWL	FAIL + AWL		VI reception data error	●	●	P253	P467	
U1300	522609	7F971	9	FAIL + AWL	FAIL + AWL		Y_ETCP1 reception time out	●	●	P254	P467	
U1302	522618	7F97A	9	FAIL + AWL	FAIL + AWL		EBC1 reception timeout	●	●	P256	P467	
U1303	522619	7F97B	9	FAIL + AWL	FAIL + AWL		Y_DPFIF reception timeout	●	●	P258	P467	
U0167	522730	7F9EA	12	FAIL + AWL	FAIL + AWL		Immobilizer error (CAN communication)	●	●	P260	P467	
U0426	1202	4B2	2	FAIL + AWL	FAIL + AWL		Immobilizer error (system)	●	●	P261	-	
U010B	522610	7F972	9	FAIL + AWL	FAIL + RSL		CAN 1	●	●	P239	P464	
U1107	522611	7F973	9	FAIL + AWL	FAIL + AWL			CAN 1 (for exhaust throttle): Reception time out	●	●	P241	P464
P0404	2791	AE7	0	FAIL + AWL	FAIL + RSL		EGR valve	●	●	P218	P459	
P1404			1	FAIL + AWL	FAIL + RSL			EGR low voltage error	●	●	P220	P459
P1409			7	FAIL + AWL	FAIL + RSL			EGR feedback error	●	●	P222	P463
U0401			9	FAIL + AWL	FAIL + RSL	EGR ECM data error		●	●	P223	P463	
P0403			12	FAIL + AWL	FAIL + RSL	Disconnection in EGR motor coils		●	●	P225	P463	
P1405			522579	7F953	12	FAIL + AWL		FAIL + RSL	Short circuit in EGR motor coils	●	●	P226
P0488	522580	7F954	12	FAIL + AWL	FAIL + RSL	EGR position sensor error		●	●	P227	P463	
P148A	522581	7F955	7	FAIL + RSL	FAIL + RSL	EGR valve sticking error		●	●	P228	P463	
P049D	522582	7F956	7	FAIL + RSL	FAIL + RSL	EGR initialization error		●	●	P229	P463	
P1410	522183	7F957	1	FAIL + AWL	FAIL + RSL	EGR high temperature thermistor error		●	●	P231	P463	
P1411	522184	7F958	1	FAIL + AWL	FAIL + RSL	EGR low temperature thermistor error		●	●	P232	P463	
U1401	522617	7F979	12	FAIL + AWL	FAIL + RSL	EGR target value out of range		●	●	P230	P463	
P1438	522746	7F9FA	12	FAIL + AWL	FAIL + AWL	Exhaust throttle		●	●	P233	-	
P1439	522747	7F9FB	12	FAIL + AWL	FAIL + AWL			Exhaust throttle (voltage fault)	●	●	P234	-
P1440	522748	7F9FC	12	FAIL + AWL	FAIL + AWL			Exhaust throttle (motor fault)	●	●	P235	-
P1441	522749	7F9FD	12	FAIL + AWL	FAIL + AWL			Exhaust throttle (sensor system fault)	●	●	P236	-
P1442	522750	7F9FE	12	FAIL + AWL	FAIL + AWL			Exhaust throttle (MPU fault)	●	●	P237	-
P1443	522751	7F9FF	19	FAIL + AWL	FAIL + AWL		Exhaust throttle (PCB fault)	●	●	P238	-	
P0601	630	276	12	FAIL + RSL	FAIL + RSL		Exhaust throttle (CAN fault)	●	●	P238	-	
P160E	522576	7F950	12	FAIL + RSL	FAIL + RSL	EEPROM	●	-	P262	P470		
P160F	522578	7F952	12	FAIL + RSL	FAIL + RSL		EEPROM memory deletion error	●	●	P263	P470	
P1613	522585	7F959	12	FAIL + RSL	FAIL + RSL		EEPROM memory reading error	●	●	P264	P470	
P1608	522588	7F95C	12	FAIL + RSL	FAIL + RSL	ECU internal fault	●	●	P265	P470		
P1617	522589	7F95D	12	FAIL + RSL	FAIL + RSL		CY146 SPI communication fault	●	●	P266	P470	
P1031	518468	7E944	12	FAIL + RSL	FAIL + RSL		Excessive voltage of supply 1	●	-	P267	P470	
P1032	518469	7E945	12	FAIL + RSL	FAIL + RSL		Insufficient voltage of supply 1	●	-	P268	P470	
P1033	518470	7E946	12	FAIL + RSL	FAIL + RSL		Shutoff 1 due to ECU internal abnormality	-	●	P269	P470	
P1034	518471	7E947	12	FAIL + RSL	FAIL + RSL		Shutoff 2 due to ECU internal abnormality	-	●	P270	P470	
P1609	522590	7F95E	12	None	None		Shutoff 3 due to ECU internal abnormality	-	●	P271	P470	
P1618	522591	7F95F	12	None	None		Shutoff 4 due to ECU internal abnormality	-	●	P272	-	
P1619	522592	7F960	12	None	None		Sensor supply voltage error 1	●	●	P273	-	
P1689	518479	7E94F	12	None	None		Sensor supply voltage error 2	●	●	P274	-	
P1626	522744	7F9F8	4	FAIL + AWL	FAIL + AWL		Sensor supply voltage error 3	●	●	P275	-	
P1633	522994	7FAF2	4	FAIL + AWL	FAIL + AWL		Sensor supply voltage error 4	-	●	P276	-	
P1467	523471	7FCCF	6	FAIL + AWL	FAIL + AWL		Actuator drive circuit 1 short to ground	●	●	P277	-	
P1469	523473	7FCD1	12	FAIL + RSL	FAIL + RSL		Actuator drive circuit 2 short to ground	●	●	P278	-	
P1470	523474	7FCD2	12	FAIL + RSL	FAIL + RSL		Actuator drive circuit 3 short to ground	●	●	P279	P470	
P1471	523475	7FCD3	12	FAIL + RSL	FAIL + RSL		AD converter fault 1	●	●	P280	P470	
P1472	523476	7FCD4	12	FAIL + RSL	FAIL + RSL		AD converter fault 2	●	●	P281	P470	
P1473	523477	7FCD5	12	FAIL + RSL	FAIL + RSL	External monitoring IC and CPU fault 1	●	-	P282	P470		
P1474	523478	7FCD6	12	FAIL + RSL	FAIL + RSL	External monitoring IC and CPU fault 2	●	-	P283	P470		
P1475	523479	7FCD7	12	FAIL + RSL	FAIL + RSL	ROM fault	●	-	P284	P470		
P1476	523480	7FCD8	12	FAIL + RSL	FAIL + RSL	Shutoff path fault 1	●	-	P285	P470		
						Shutoff path fault 2	●	-	P286	P470		
						Shutoff path fault 3	●	-				

DTC (Diagnostic Trouble Codes) General Description

DTC code				Lamp that comes on (Tier4)	Lamp that comes on (Stage V)	Error		ECU type		Reference page	
P code	SPN		FMI			Part	State	EDC 17	MD1	Description	Diagnosis
	Decima number	Hexa-decimal number	Decima number								
P1477	523481	7FCD9	12	FAIL + RSL	FAIL + RSL	ECU internal fault	Shutoff path fault 4	●	–	P287	P470
P1478	523482	7FCDA	12	FAIL + RSL	FAIL + RSL		Shutoff path fault 5	●	–	P288	P470
P1479	523483	7FCDB	12	FAIL + RSL	FAIL + RSL		Shutoff path fault 6	●	–	P289	P470
P1480	523484	7FCDC	12	FAIL + RSL	FAIL + RSL		Shutoff path fault 7	●	–	P290	P470
P1481	523485	7FCDD	12	FAIL + RSL	FAIL + RSL		Shutoff path fault 8	●	–	P291	P470
P1482	523486	7FCDE	12	FAIL + RSL	FAIL + RSL		Shutoff path fault 9	●	–	P292	P470
P1483	523487	7FCDF	12	FAIL + RSL	FAIL + RSL		Shutoff path fault 10	●	–	P293	P470
P1035	518472	7E948	12	FAIL + RSL	FAIL + RSL		Shut-off path abnormality by external monitoring IC and CPU	–	●	P294	P470
P1484	523488	7FCE0	0	FAIL + RSL	FAIL + RSL		Recognition error of engine speed	●	●	P295	–
P053A	3059	BF3	5	FAIL + AWL	FAIL + AWL		Breather heater (Optional parts for 4TNV86CT and 4TNV98CT)	Breather heater disconnection	●	●	P296
P053B			4	FAIL + AWL	FAIL + AWL	Breather heater short circuit (GND)		●	●	P297	P417
P053C			3	FAIL + AWL	FAIL + AWL	Breather heater short circuit (VB)		●	●	P298	P417
P1101	522323	7F853	0	Application specific	Application specific	Air cleaner switch	Air cleaner clogged alarm	●	●	P299	P424
P1151	522329	7F859	0	Application specific	Application specific	Water separator switch	Water separator alarm	●	●	P301	P424
P1562	167	A7	5	Application specific	Application specific	Charge switch	Charge switch open circuit	●	●	P303	P421
P1568			1	Application specific	Application specific		Charge alarm	●	●	P305	P421
P1192	100	64	4	Application specific	Application specific	Oil pressure switch	Oil pressure switch open circuit	●	●	P307	P421
P1198			1	Application specific	Application specific		Low oil pressure fault alarm	●	●	P309	P421
P2463	522573	7F94D	0	Not comes on	Not comes on	DPF	Excessive PM accumulation (method C)	●	●	P311	–
P1463	522574	7F94E	0	Not comes on	Not comes on		Excessive PM accumulation (method P)	●	●	P312	–
P2458	522575	7F94F	7	Not comes on	Not comes on		Regeneration failure (stationary regeneration failure)	●	●	P313	–
P2459	522577	7F951	11	Not comes on	Not comes on		Regeneration failure (stationary regeneration not performed)	●	●	P314	–
P1426	3250	CB2	0	FAIL + RSL	FAIL + RSL	DPF intermediate temperature sensor	DPF intermediate temperature sensor temperature rise error (post-injection failure)	●	●	P315	P378
P242F	3720	E88	16	FAIL + AWL	FAIL + AWL	DPF OP interface	Ash cleaning request 1	●	●	P316	–
P1420			0	FAIL + RSL	FAIL + RSL		Ash cleaning request 2	●	●	P317	–
P1421	3719	E87	16	FAIL + AWL	FAIL + AWL		Stationary regeneration standby	●	●	P318	–
P1424			0	FAIL + RSL	FAIL + RSL		Backup mode	●	●	P319	–
P1425	3695	E6F	14	Not comes on	Not comes on		Reset regeneration is inhibited	●	●	P320	–
P1445	3719	E87	9	FAIL + RSL	FAIL + RSL		Recovery regeneration failure	●	●	P321	–
P1446			7	FAIL + RSL	FAIL + RSL		Recovery regeneration is inhibited	●	●	P322	–

Additional requirements for EU Stage V (less than 56 kW) regulations

Due to the enactment of EU Stage V emission regulations from January 2019, the following additional legal requirements now apply to engines of less than 56 kW.

1. Installation of a NCD (NOx Control Diagnostic System) (EGR valve controls NOx)
 - Detects failure or illegal modification of NOx control system, and failure of the NCD itself.
 - Alerts operator when failure etc. is detected.
 - Incremental engine derating (inducement) is applied to prompt the operator to take action.
2. Installation of a PCD (Particulate Diagnostic System)
 - Detects removal/loss of function of DPF, and failure of the DPF itself.
 - Alerts operator when failure etc. is detected.
 - Addition of incident counter/timer

■ Power restrictions due to inducement when NCD abnormality occurs

Inducement refers to restrictions (limitations) which are placed on engine speed/fuel injection quantity in cases whereby emission reduction control ceases to function normally due to the occurrence of an abnormality in the emission reduction equipment (EGR system) installed to the engine. Inducement is activated when an abnormality is detected in the EGR system. This is to prevent the engine from continuing to be used while EGR control is not functioning normally. If the engine continues to be used once inducement is activated, the engine speed/fuel injection quantity are reduced to a point at which work is almost impossible. Repair the error, immediately.

There are three inducement levels caused by EGR system abnormality. The level increases incrementally according to the amount of operating time elapsed since the abnormality occurred.

a. Warning

When engine operation time is less than 36 hours since abnormality occurred.

In this case, restrictions on engine speed/fuel injection quantity vary depending on the error.

b. Inducement (Low level)

When engine operation time is 36 hours or more but less than 100 hours since abnormality occurred (or less than 5 hours (*1)). In this case, the torque is limited to 75%.

(For some errors, the engine speed is restricted to low idle and the maximum fuel injection quantity is restricted to 50%.)

c. Inducement (Severe level)

When engine operation time is 100 hours or more since abnormality occurred (or 5 hours or more (*1)). In this case, the engine speed is restricted to 60% of its rated speed (in some engine models), and the torque is restricted to 50%.

(For some errors, the engine speed is restricted to low idle and the maximum fuel injection quantity is restricted to 50%.)

The figure below shows a relation between inducement and the engine operation time since the abnormality occurred. Inducement cannot be canceled by stopping and re-starting the engine during an error occurrences. The inducement level at the time when the engine is stopped remains in effect.

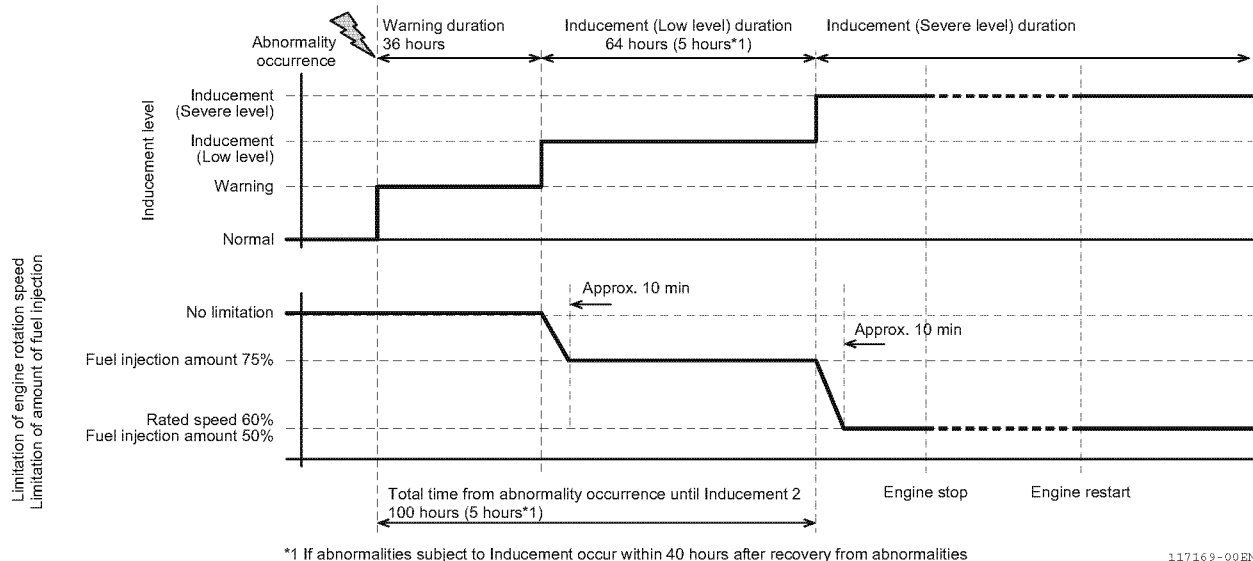

Relation between inducement and the engine operation time elapsed since abnormality occurrence

(*1) This time indicates a case when another abnormality that results in inducement occurs within 40 hours of recovery from a previous abnormality.

When inducement is activated during a PCD abnormality, there is no error display or power restrictions.

■ How to clear the error subject to inducement (NCD error) display

The display of the inducement error (NCD error) triggered by “current failure (abnormality occurring)” cannot be cleared by the failure display clearing function of SA-D (SmartAssist Direct). If clearing is required, use the inducement clearing function of SA-D (SmartAssist Direct).

Whether each error display can be cleared

SA-D fault display clear command	Whether error display can be cleared			
	Error not subject to inducement		Error subject to inducement (NCD error)	
	Current failure	Failure history	Current failure	Failure history
Fault display: clear	Clearable	Clearable	Not clearable	Clearable
Inducement: clear	Not clearable	Not clearable	Clearable	Not clearable

Description

P code	PO000	Name	Error name
SPN/FMI	△△…△/□□		

● DTC detection criteria

1. Prerequisite, 2. Judgment criteria	Check points
1. Prerequisite for detecting the error. 2. Condition for detecting the error.	Check point to specify the cause of the error. See "Diagnosis" for details.

● Actions when an error occurs

Fault mode	[Continuous operation] / [Limited operation] / [Engine stop]: Describes the engine operation when an error is detected. * [Continuous operation]: The engine continues to operate without limitations even after an error is detected. Engine control is not obstructed. [Limited operation]: The engine operation continues, but the high idle speed and engine power are limited. [Engine stop]: The engine stops immediately when an error is detected. If the error is detected before starting the engine, the key switch does not turn.
Limited operation	Yes/No: The details of limited operation at the time of error are listed.
Reset criteria	Yes/No: The condition to release the fault mode is listed.
Remarks	Precaution is listed.

● Presumed cause of the failure or the error condition

Judging from the detected DTC, the presumed location and cause of the error (e.g. disconnection of sensor wiring) or the error condition of the system (e.g. abnormal rise of engine coolant temperature) are listed.

* Malfunctions related to the detected DTC are listed.

● Diagnosis

The method and procedure of the failure diagnosis are listed. Use YANMAR failure diagnosis tool, SMARTASSIST-DIRECT (SA-D), for initial diagnosis.

Note: If replacing the ECU, sensor, or actuator fixes the malfunction, re-install the presumably broken parts and check that the malfunction re-occurs.

Sensor related

■ Crankshaft speed sensor

P0336: Crankshaft signal error

P code	P0336	Name	Crankshaft signal error
SPN/FMI	522400/2		

● DTC detection criteria

1. Prerequisite, 2. Judgment criteria	Check points
1. No prerequisite. 2. Abnormal pulse detected for a constant number of times (25 times).	Connector Wire-harness Crankshaft speed sensor ECU Pulser

● Actions when an error occurs

Fault mode	[Limited operation]: The engine operation is limited. (The operation continues with only the camshaft speed sensor.)
Limited operation	Yes: • When sensor error occurs, rated output of the engine is reduced immediately. • The maximum engine torque is limited to 85%. • Rated output of the engine is reduced further after 120 min. • The maximum engine torque is limited to 50%.
Reset criteria	Yes: When the ECU power is turned off, the fault mode is released.
Remarks	

● Presumed cause of the failure or the error condition

1. Poor connection of connector
2. Wiring failure of the wire-harness
3. Crankshaft speed sensor failure
4. ECU internal circuit failure
5. Pulser error and sensor installation condition error

● Diagnosis

1. Initial diagnosis using SA-D	<ul style="list-style-type: none">• Check the fault indication. <p>* See Chapter 2 P328 for details on the diagnosis method and procedure.</p>
---------------------------------	--

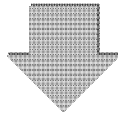

2. Connector/wiring check	<ul style="list-style-type: none">• Before beginning your work, be sure to turn off the ECU power.• Check the pin of the crankshaft speed sensor for deformation and cracks, the condition of the connection, and whether the retainer is loose or removed.• Make sure that the crankshaft speed sensor wiring is not cut or the wiring coating is not peeled.
---------------------------	--

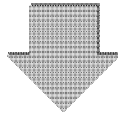

3. Failure diagnosis	<ul style="list-style-type: none">• Check the crankshaft speed sensor resistance value.• Check the conduction of the wire-harness.• Check the crankshaft speed sensor mounting condition and pulser. <p>* See Chapter 2 P328 for details on the diagnosis method and procedure.</p>
----------------------	---

P0337: No signal from crankshaft

P code	P0337	Name	No signal from crankshaft
SPN/FMI	522400/5		

● **DTC detection criteria**

1. Prerequisite, 2. Judgment criteria	Check points
1. No prerequisite. 2. No pulse input of crankshaft speed sensor while the cam is rotating for a certain number of rotations (2 rotations).	Connector Wire-harness Crankshaft speed sensor ECU Pulser

● **Actions when an error occurs**

Fault mode	[Limited operation]: The engine operation is limited. (The operation continues with only the camshaft speed sensor.)
Limited operation	Yes: • When sensor error occurs, rated output of the engine is reduced immediately. • The maximum engine torque is limited to 85%. • Rated output of the engine is reduced further after 120 min. • The maximum engine torque is limited to 50%.
Reset criteria	Yes: When the ECU power is turned off, the fault mode is released.
Remarks	

● **Presumed cause of the failure or the error condition**

1. Poor connection of connector
2. Wiring failure of the wire-harness
3. Crankshaft speed sensor failure
4. ECU internal circuit failure
5. Pulser error and sensor installation condition error

● Diagnosis

1. Initial diagnosis using SA-D	<ul style="list-style-type: none">• Check the fault indication. <p>* See Chapter 2 P328 for details on the diagnosis method and procedure.</p>
---------------------------------	--

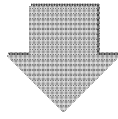

2. Connector/wiring check	<ul style="list-style-type: none">• Before beginning your work, be sure to turn off the ECU power.• Check the pin of the crankshaft speed sensor for deformation and cracks, the condition of the connection, and whether the retainer is loose or removed.• Make sure that the crankshaft speed sensor wiring is not cut or the wiring coating is not peeled.
---------------------------	--

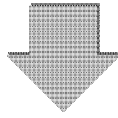

3. Failure diagnosis	<ul style="list-style-type: none">• Check the crankshaft speed sensor resistance value.• Check the conduction of the wire-harness.• Check the crankshaft speed sensor mounting condition and pulser. <p>* See Chapter 2 P328 for details on the diagnosis method and procedure.</p>
----------------------	---

■ Camshaft speed sensor

P0341: Camshaft signal error

P code	P0341	Name	Camshaft signal error
SPN/FMI	522401/2		

● DTC detection criteria

1. Prerequisite, 2. Judgment criteria	Check points
1. No prerequisite. 2. Incorrect pulse number of camshaft speed sensor or incorrect position detected while the crank is rotating for a certain number of rotations (4 rotations).	Connector Wire-harness Camshaft speed sensor ECU Pulser

● Actions when an error occurs

Fault mode	[Continuous operation]: Engine control is not obstructed. (The operation continues with only the crankshaft speed sensor.)
Limited operation	No
Reset criteria	Yes: When the ECU power is turned off, the fault mode is released.
Remarks	

● Presumed cause of the failure or the error condition

1. Poor connection of connector
2. Wiring failure of the wire-harness
3. Camshaft speed sensor fault
4. ECU internal circuit failure
5. Pulser error and sensor installation condition error

● Diagnosis

1. Initial diagnosis using SA-D	<ul style="list-style-type: none">• Check the fault indication. <p>* See Chapter 2 <i>P331</i> for details on the diagnosis method and procedure.</p>
---------------------------------	---

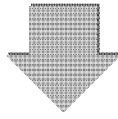

2. Connector/wiring check	<ul style="list-style-type: none">• Before beginning your work, be sure to turn off the ECU power.• Check the pin of the camshaft speed sensor for deformation and cracks, the condition of the connection, and whether the retainer is loose or removed.• Make sure that the camshaft speed sensor wiring is not cut or the wiring coating is not peeled.
---------------------------	--

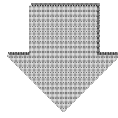

3. Failure diagnosis	<ul style="list-style-type: none">• Check the conduction of the wire-harness.• Check the ECU output voltage. <p>* See Chapter 2 <i>P331</i> for details on the diagnosis method and procedure.</p>
----------------------	---

P0342: No signal from camshaft

P code	P0342	Name	No signal from camshaft
SPN/FMI	522401/5		

● DTC detection criteria

1. Prerequisite, 2. Judgment criteria	Check points
1. No prerequisite. 2. No pulse input of camshaft speed sensor while the crank is rotating for a certain number of rotations (2.2 rotations).	Connector Wire-harness Camshaft speed sensor ECU Pulser

● Actions when an error occurs

Fault mode	[Continuous operation]: Engine control is not obstructed. (The operation continues with only the crankshaft speed sensor.)
Limited operation	No
Reset criteria	Yes: When the ECU power is turned off, the fault mode is released.
Remarks	

● Presumed cause of the failure or the error condition

1. Poor connection of connector
2. Wiring failure of the wire-harness
3. Camshaft speed sensor failure
4. ECU internal circuit failure
5. Pulser error and sensor installation condition error

● Diagnosis

1. Initial diagnosis using SA-D	<ul style="list-style-type: none">• Check the fault indication. <p>* See Chapter 2 <i>P331</i> for details on the diagnosis method and procedure.</p>
---------------------------------	---

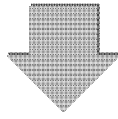

2. Connector/wiring check	<ul style="list-style-type: none">• Before beginning your work, be sure to turn off the ECU power.• Check the pin of the camshaft speed sensor for deformation and cracks, the condition of the connection, and whether the retainer is loose or removed.• Make sure that the camshaft speed sensor wiring is not cut or the wiring coating is not peeled.
---------------------------	--

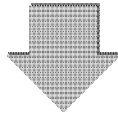

3. Failure diagnosis	<ul style="list-style-type: none">• Check the conduction of the wire-harness.• Check the ECU output voltage. <p>* See Chapter 2 <i>P331</i> for details on the diagnosis method and procedure.</p>
----------------------	---

P1341: Angle offset error

P code	P1341	Name	Angle offset error
SPN/FMI	522401/7		

● DTC detection criteria

1. Prerequisite, 2. Judgment criteria	Check points
1. No prerequisite. 2. The condition with the phase difference of 30 degrees or larger, or -20 degrees or smaller between the cam and the crank is detected for 2 times.	Connector Wire-harness Camshaft speed sensor ECU Pulser

● Actions when an error occurs

Fault mode	[Continuous operation]: Engine control is not obstructed.
Limited operation	No
Reset criteria	Yes: When the ECU power is turned off, the fault mode is released.
Remarks	

● Presumed cause of the failure or the error condition

1. Poor connection of connector
2. Wiring failure of the wire-harness
3. Camshaft speed sensor failure
4. ECU internal circuit failure
5. Pulser error and sensor installation condition error

● Diagnosis

1. Initial diagnosis using SA-D	<ul style="list-style-type: none">• Check the fault indication.
---------------------------------	---

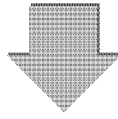

2. Connector/wiring check	<ul style="list-style-type: none">• Before beginning your work, be sure to turn off the ECU power.• Check the pin of the crankshaft speed sensor, camshaft speed sensor for deformation and cracks, the condition of the connection, and whether the retainer is loose or removed.• Make sure that the camshaft speed sensor wiring is not cut or the wiring coating is not peeled.
---------------------------	---

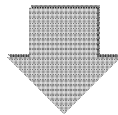

3. Pulser check	<ul style="list-style-type: none">• Before beginning your work, be sure to turn off the ECU power.• Check that there is no abnormality in distance and displacement of the pulser and the sensor.
-----------------	--

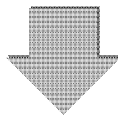

4. Failure diagnosis	<ul style="list-style-type: none">• Check the conduction of the wire-harness.• Check the ECU output voltage.
----------------------	---

P0008: No signal on both crankshaft and camshaft speed sensor

P code	P0008	Name	No signal on both crankshaft and camshaft speed sensor
SPN/FMI	523249/5		

● **DTC detection criteria**

1. Prerequisite, 2. Judgment criteria	Check points
1. During cranking. 2. For 10 seconds, no signal is detected from crankshaft speed sensor or camshaft speed sensor.	Connector Wire-harness Crankshaft speed, Camshaft speed sensor ECU Pulser

● **Actions when an error occurs**

Fault mode	[Engine stop]: The engine operation stops.
Limited operation	Yes: Fuel injection stops.
Reset criteria	Yes: When the ECU power is turned off, the fault mode is released.
Remarks	

● **Presumed cause of the failure or the error condition**

1. Crankshaft speed sensor failure and camshaft speed sensor failure occur at the same time
2. Starter system failure

● **Diagnosis**

1. Initial diagnosis using SA-D	<ul style="list-style-type: none"> • Check the fault indication. <p>* See Chapter 2 P328, P331 for details on the diagnosis method and procedure.</p>
---------------------------------	--

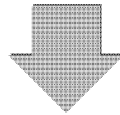

2. Connector/wiring check	<ul style="list-style-type: none"> • Before beginning your work, be sure to turn off the power switch. • Check the pin of the crankshaft speed sensor, camshaft speed sensor for deformation and cracks, the condition of the connection, and whether the retainer is loose or removed. • Make sure that the crankshaft speed sensor and camshaft speed sensor wiring is not cut or the wiring coating is not peeled. • If the starter is turned on but the engine does not turn, check the starter system.
---------------------------	---

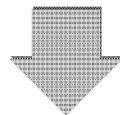

3. Failure diagnosis	<ul style="list-style-type: none"> • Perform the failure diagnosis on the crankshaft speed sensor and camshaft speed sensor.
----------------------	---

■ Accelerator sensor

P0123: Accelerator sensor 1 error (voltage high)

P code	P0123	Name	Accelerator sensor 1 error (voltage high)
SPN/FMI	91/3		

● DTC detection criteria

1. Prerequisite, 2. Judgment criteria	Check points
1. No prerequisite. 2. Sensor output is higher than threshold 4.6 V.	Connector Wire-harness Accelerator sensor ECU

● Actions when an error occurs

	Backup accelerator sensor function	
	No	Yes
Fault mode	[Limited operation]: The engine operates at a constant speed.	[Continuous operation]: Switches to engine operation through a backup accelerator sensor.
Limited operation	Yes: The target rotation speed is set to "target rotation speed during error" or "target rotation speed before error detection". (Action differs depending on each customer's settings.)	No
Reset criteria	Yes: When the ECU is turned off with the normal voltage (0.2 to 4.6 V) supplied, the fault mode is released.	Yes: When the ECU power off is detected, the fault mode is released.
Remarks		

● Presumed cause of the failure or the error condition

1. Poor connection of connector
2. Wiring failure of the wire-harness
3. Accelerator sensor failure
4. ECU internal circuit failure

● **Diagnosis**

1. Initial diagnosis using SA-D	<ul style="list-style-type: none"> • Check the fault indication. • Check the sensor voltage. <p>* See Chapter 2 P334 for details on the diagnosis method and procedure.</p>
---------------------------------	---

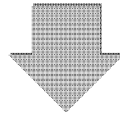

2. Connector/wiring check	<ul style="list-style-type: none"> • Before beginning your work, be sure to turn off the ECU power. • Check the connector pin of the accelerator sensor 2 for deformation and cracks, the condition of the connection, and whether the retainer is loose or removed. • Make sure that the accelerator sensor wiring is not cut or the wiring coating is not peeled.
---------------------------	--

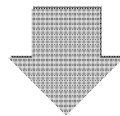

3. Failure diagnosis	<ul style="list-style-type: none"> • Check the accelerator sensor resistance value. • Check the conduction of the wire-harness. • Check the accelerator sensor output voltage. <p>* See Chapter 2 P334 for details on the diagnosis method and procedure.</p>
----------------------	--

P0122: Accelerator sensor 1 error (voltage low)

P code	P0122	Name	Accelerator sensor 1 error (voltage low)
SPN/FMI	91/4		

● **DTC detection criteria**

1. Prerequisite, 2. Judgment criteria	Check points
1. No prerequisite. 2. Sensor output is lower than threshold 0.2 V.	Connector Wire-harness Accelerator sensor ECU

● **Actions when an error occurs**

	Backup accelerator sensor function	
	No	Yes
Fault mode	[Limited operation]: The engine operates at a constant speed.	[Continuous operation]: Switches to engine operation through a backup accelerator sensor.
Limited operation	Yes: The target rotation speed is set to "target rotation speed during error" or "target rotation speed before error detection". (Action differs depending on each customer's settings.)	No
Reset criteria	Yes: When the ECU is turned off with the normal voltage (0.2 to 4.6 V) supplied, the fault mode is released.	Yes: When the ECU power off is detected, the fault mode is released.
Remarks		

● **Presumed cause of the failure or the error condition**

1. Poor connection of connector
2. Wiring failure of the wire-harness
 - Disconnection or GND short circuit of sensor 5 V
3. Accelerator sensor failure
4. ECU internal circuit failure

● **Diagnosis**

1. Initial diagnosis using SA-D	<ul style="list-style-type: none"> • Check the fault indication. • Check the sensor voltage. <p>* See Chapter 2 P334 for details on the diagnosis method and procedure.</p>
---------------------------------	---

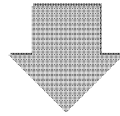

2. Connector/wiring check	<ul style="list-style-type: none"> • Before beginning your work, be sure to turn off the ECU power. • Check the connector pin of the accelerator sensor for deformation and cracks, the condition of the connection, and whether the retainer is loose or removed. • Make sure that the accelerator sensor wiring is not cut or the wiring coating is not peeled.
---------------------------	--

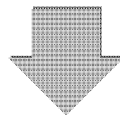

3. Failure diagnosis	<ul style="list-style-type: none"> • Check the accelerator sensor resistance value. • Check the conduction of the wire-harness. • Check the accelerator sensor output voltage. <p>* See Chapter 2 P334 for details on the diagnosis method and procedure.</p>
----------------------	--

P0223: Accelerator sensor 2 error (voltage high)

P code	P0223	Name	Accelerator sensor 2 error (voltage high)
SPN/FMI	28/3		

● **DTC detection criteria**

1. Prerequisite, 2. Judgment criteria	Check points
1. No prerequisite. 2. Sensor output is higher than threshold 4.6 V.	Connector Wire-harness Accelerator sensor ECU

● **Actions when an error occurs**

Fault mode	[Continuous operation]: Engine control is not obstructed.
Limited operation	No
Reset criteria	Yes: When the ECU power is turned off, the fault mode is released.
Remarks	

● **Presumed cause of the failure or the error condition**

1. Poor connection of connector
2. Wiring failure of the wire-harness
 - Disconnection or GND short circuit of sensor 5 V
3. Accelerator sensor failure
4. ECU internal circuit failure

● Diagnosis

1. Initial diagnosis using SA-D	<ul style="list-style-type: none">• Check the fault indication.• Check the sensor voltage. <p>* See Chapter 2 P334 for details on the diagnosis method and procedure.</p>
---------------------------------	--

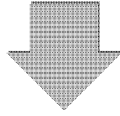

2. Connector/wiring check	<ul style="list-style-type: none">• Before beginning your work, be sure to turn off the ECU power.• Check the connector pin of the accelerator sensor for deformation and cracks, the condition of the connection, and whether the retainer is loose or removed.• Make sure that the accelerator sensor wiring is not cut or the wiring coating is not peeled.
---------------------------	--

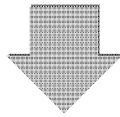

3. Failure diagnosis	<ul style="list-style-type: none">• Check the accelerator sensor resistance value.• Check the conduction of the wire-harness.• Check the accelerator sensor output voltage. <p>* See Chapter 2 P334 for details on the diagnosis method and procedure.</p>
----------------------	--

P0222: Accelerator sensor 2 error (voltage low)

P code	P0222	Name	Accelerator sensor 2 error (voltage low)
SPN/FMI	28/4		

● **DTC detection criteria**

1. Prerequisite, 2. Judgment criteria	Check points
1. No prerequisite. 2. Sensor output is lower than threshold 0.2 V.	Connector Wire-harness Accelerator sensor ECU

● **Actions when an error occurs**

Fault mode	[Continuous operation]: Engine control is not obstructed.
Limited operation	No
Reset criteria	Yes: When the ECU power is turned off, the fault mode is released.
Remarks	

● **Presumed cause of the failure or the error condition**

1. Poor connection of connector
2. Wiring failure of the wire-harness
 - Disconnection or GND short circuit of sensor 5 V
3. Accelerator sensor failure
4. ECU internal circuit failure

● **Diagnosis**

1. Initial diagnosis using SA-D	<ul style="list-style-type: none"> • Check the fault indication. • Check the sensor voltage. <p>* See Chapter 2 P334 for details on the diagnosis method and procedure.</p>
---------------------------------	---

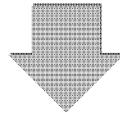

2. Connector/wiring check	<ul style="list-style-type: none"> • Before beginning your work, be sure to turn off the ECU power. • Check the connector pin of the accelerator sensor for deformation and cracks, the condition of the connection, and whether the retainer is loose or removed. • Make sure that the accelerator sensor wiring is not cut or the wiring coating is not peeled.
---------------------------	--

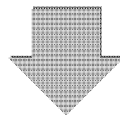

3. Failure diagnosis	<ul style="list-style-type: none"> • Check the accelerator sensor resistance value. • Check the conduction of the wire-harness. • Check the accelerator sensor output voltage. <p>* See Chapter 2 P334 for details on the diagnosis method and procedure.</p>
----------------------	--

P1646: Dual accelerator sensor error (closed position)

P code	P1646	Name	Dual accelerator sensor error (closed position)
SPN/FMI	522624/7		

● **DTC detection criteria**

1. Prerequisite, 2. Judgment criteria	Check points
1. No prerequisite. 2. (APS2 terminal voltage - Estimated APS2 terminal voltage) is greater than the [Detected value of the dual accelerator sensor fault].	Connector Wire-harness Accelerator sensor 1 Accelerator sensor 2 ECU

● **Actions when an error occurs**

Fault mode	[Continuous operation]: Engine control is not obstructed.
Limited operation	No
Reset criteria	Yes: When the ECU power is turned off, the fault mode is released.
Remarks	

● **Presumed cause of the failure or the error condition**

1. Poor connection of connector
2. Wiring failure of the wire-harness
 - Disconnection or GND short circuit of sensor 5 V
3. Accelerator 1 sensor failure
4. Accelerator 2 sensor failure
5. ECU internal circuit failure

● Diagnosis

1. Initial diagnosis using SA-D	<ul style="list-style-type: none">• Check the fault indication.• Check the sensor voltage.
---------------------------------	---

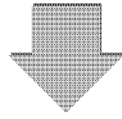

2. Connector/wiring check	<ul style="list-style-type: none">• Before beginning your work, be sure to turn off the ECU power.• Check the connector pin of the accelerator sensor for deformation and cracks, the condition of the connection, and whether the retainer is loose or removed.• Make sure that the accelerator sensor wiring is not cut or the wiring coating is not peeled.
---------------------------	--

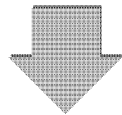

3. Failure diagnosis	<ul style="list-style-type: none">• Check the accelerator sensor resistance value.• Check the conduction of the wire-harness.• Check the accelerator sensor output voltage.
----------------------	---

P1647: Dual accelerator sensor error (open position)

P code	P1647	Name	Dual accelerator sensor error (open position)
SPN/FMI	522623/7		

● **DTC detection criteria**

1. Prerequisite, 2. Judgment criteria	Check points
1. No prerequisite. 2. (Estimated APS2 terminal voltage - APS2 terminal voltage) is greater than the [Detected value of the dual accelerator sensor fault].	Connector Wire-harness Accelerator sensor 1 Accelerator sensor 2 ECU

● **Actions when an error occurs**

Fault mode	[Continuous operation]: Engine control is not obstructed.
Limited operation	No
Reset criteria	Yes: When the ECU power is turned off, the fault mode is released.
Remarks	

● **Presumed cause of the failure or the error condition**

1. Poor connection of connector
2. Wiring failure of the wire-harness
 - Disconnection or GND short circuit of sensor 5 V
3. Accelerator 1 sensor failure
4. Accelerator 2 sensor failure
5. ECU internal circuit failure

● Diagnosis

1. Initial diagnosis using SA-D	<ul style="list-style-type: none">• Check the fault indication.• Check the sensor voltage.
---------------------------------	---

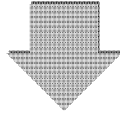

2. Connector/wiring check	<ul style="list-style-type: none">• Before beginning your work, be sure to turn off the ECU power.• Check the connector pin of the accelerator sensor for deformation and cracks, the condition of the connection, and whether the retainer is loose or removed.• Make sure that the accelerator sensor wiring is not cut or the wiring coating is not peeled.
---------------------------	--

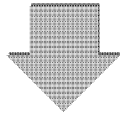

3. Failure diagnosis	<ul style="list-style-type: none">• Check the accelerator sensor resistance value.• Check the conduction of the wire-harness.• Check the accelerator sensor output voltage.
----------------------	---

P0228: Accelerator sensor 3 error (voltage high)

P code	P0228	Name	Accelerator sensor 3 error (voltage high)
SPN/FMI	29/3		

● **DTC detection criteria**

1. Prerequisite, 2. Judgment criteria	Check points
1. No prerequisite. 2. Sensor output is higher than threshold 4.6 V.	Connector Wire-harness Accelerator sensor 3 ECU

● **Actions when an error occurs**

Fault mode	[Continuous operation]: Engine control is not obstructed.
Limited operation	No
Reset criteria	Yes: When the ECU power is turned off, the fault mode is released.
Remarks	

● **Presumed cause of the failure or the error condition**

1. Poor connection of connector
2. Wiring failure of the wire-harness
 - Disconnection of the sensor GND wire
 - Power short circuit of the sensor signal wire
3. Accelerator sensor 3 failure
 - Sensor output failure by power short circuit of accelerator sensor 3 internal wiring
4. ECU internal circuit failure

● **Diagnosis**

1. Initial diagnosis using SA-D	<ul style="list-style-type: none"> • Check the fault indication. • Check the sensor voltage. <p>* See Chapter 2 P334 for details on the diagnosis method and procedure.</p>
---------------------------------	---

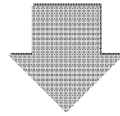

2. Connector/wiring check	<ul style="list-style-type: none"> • Before beginning your work, be sure to turn off the power switch. • Check the connector pin of the accelerator sensor 3 for deformation and cracks, the condition of the connection, and whether the retainer is loose or removed. • Make sure that the accelerator sensor 3 wiring is not cut or the wiring coating is not peeled.
---------------------------	---

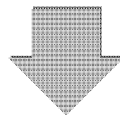

3. Failure diagnosis	<ul style="list-style-type: none"> • Check the accelerator sensor 3 resistance value. • Check the conduction of the wire-harness. • Check the accelerator sensor 3 output voltage. <p>* See Chapter 2 P334 for details on the diagnosis method and procedure.</p>
----------------------	--

P0227: Accelerator sensor 3 error (voltage low)

P code	P0227	Name	Accelerator sensor 3 error (voltage low)
SPN/FMI	29/4		

● **DTC detection criteria**

1. Prerequisite, 2. Judgment criteria	Check points
1. No prerequisite. 2. Sensor output is lower than threshold 0.2 V.	Connector Wire-harness Accelerator sensor 3 ECU

● **Actions when an error occurs**

Fault mode	[Continuous operation]: Engine control is not obstructed.
Limited operation	No
Reset criteria	Yes: When the ECU power is turned off, the fault mode is released.
Remarks	

● **Presumed cause of the failure or the error condition**

1. Poor connection of connector
2. Wiring failure of the wire-harness
 - Disconnection or GND short circuit of the accelerator sensor 3 signal wire
 - Disconnection or GND short circuit of sensor 5 V
3. Accelerator sensor 3 failure
 - Sensor output failure caused by disconnection or an increase in sliding friction of the accelerator sensor 3 internal wiring
4. ECU internal circuit failure

● **Diagnosis**

1. Initial diagnosis using SA-D	<ul style="list-style-type: none"> • Check the fault indication. • Check the sensor voltage. <p>* See Chapter 2 P334 for details on the diagnosis method and procedure.</p>
---------------------------------	---

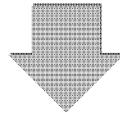

2. Connector/wiring check	<ul style="list-style-type: none"> • Before beginning your work, be sure to turn off the power switch. • Check the connector pin of the accelerator sensor 3 for deformation and cracks, the condition of the connection, and whether the retainer is loose or removed. • Make sure that the accelerator sensor 3 wiring is not cut or the wiring coating is not peeled.
---------------------------	---

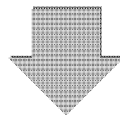

3. Failure diagnosis	<ul style="list-style-type: none"> • Check the accelerator sensor 3 resistance value. • Check the conduction of the wire-harness. • Check the accelerator sensor 3 output voltage. <p>* See Chapter 2 P334 for details on the diagnosis method and procedure.</p>
----------------------	--

P1227: Pulse accelerator sensor error (pulse communication)

P code	P1227	Name	Pulse accelerator sensor error (pulse communication)
SPN/FMI	29/8		

● **DTC detection criteria**

1. Prerequisite, 2. Judgment criteria	Check points
1. Key switch ON. 2. No pulse accelerator signal input.	Connector Wire-harness ECU

● **Actions when an error occurs**

Fault mode	[Continuous operation]: Engine control is not obstructed.
Limited operation	No
Reset criteria	Yes: When the ECU power is turned off, the fault mode is released.
Remarks	

● **Presumed cause of the failure or the error condition**

● **Diagnosis**

P1126: Accelerator sensor 3 error (foot pedal in open position)

P code	P1126	Name	Accelerator sensor 3 error (foot pedal in open position)
SPN/FMI	28/0		

● DTC detection criteria

1. Prerequisite, 2. Judgment criteria	Check points
1. No prerequisite. 2. When the APS3 input voltage is 1.1 V or above and the PDLSW terminal is low level (PDLSW terminal: Open setting).	Connector Wire-harness Foot pedal ECU

● Actions when an error occurs

Fault mode	[Continuous operation]: Engine control is not obstructed.
Limited operation	No
Reset criteria	Yes: When the ECU power is turned off, the fault mode is released.
Remarks	

● Presumed cause of the failure or the error condition

1. Poor connection of connector
2. Wiring failure of the wire-harness
 - Disconnection or GND short circuit of the foot pedal signal wire
 - Disconnection or GND short circuit of sensor 5 V
3. Foot pedal failure
 - Sensor output failure caused by disconnection or an increase in sliding friction of the foot pedal internal wiring
4. ECU internal circuit failure

● Diagnosis

1. Initial diagnosis using SA-D	<ul style="list-style-type: none">• Check the fault indication.• Check the sensor voltage.
---------------------------------	---

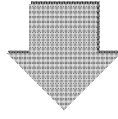

2. Connector/wiring check	<ul style="list-style-type: none">• Before beginning your work, be sure to turn off the power switch.• Check the connector pin of the foot pedal for deformation and cracks, the condition of the connection, and whether the retainer is loose or removed.• Make sure that the foot pedal wiring is not cut or the wiring coating is not peeled.
---------------------------	---

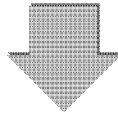

3. Failure diagnosis	<ul style="list-style-type: none">• Check the foot pedal resistance value.• Check the conduction of the wire-harness.• Check the accelerator sensor output voltage.
----------------------	---

P1125: Accelerator sensor 3 error (foot pedal in closed position)

P code	P1125	Name	Accelerator sensor 3 error (foot pedal in closed position)
SPN/FMI	28/1		

● DTC detection criteria

1. Prerequisite, 2. Judgment criteria	Check points
1. No prerequisite. 2. When the APS3 input voltage is 0.65 V or below and the PDLSW terminal is high level (PDLSW terminal: Open setting).	

● Actions when an error occurs

Fault mode	[Continuous operation]: Engine control is not obstructed.
Limited operation	No
Reset criteria	Yes: When the ECU power is turned off, the fault mode is released.
Remarks	

● Presumed cause of the failure or the error condition**● Diagnosis**

■ Intake throttle position sensor

P02E9: Intake throttle position sensor error (voltage high)

P code	P02E9	Name	Intake throttle position sensor error (voltage high)
SPN/FMI	51/3		

● DTC detection criteria

1. Prerequisite, 2. Judgment criteria	Check points
1. No prerequisite. 2. Sensor output is higher than threshold 4.8 V.	Connector Wire-harness Intake throttle position sensor ECU

● Actions when an error occurs

Fault mode	[Limited operation]: Intake throttle position is set to 100% as the default value. The engine operation is limited.
Limited operation	Yes: • When sensor error occurs, rated output of the engine is reduced immediately. <ul style="list-style-type: none"> • The maximum engine torque is limited to 85%. • EGR fully closes. • Intake throttle fully opens. • DPF regeneration stops. • Rated output of the engine is reduced further after 120 min. • The maximum engine torque is limited to 50%.
Reset criteria	Yes: When the ECU power is turned off, the fault mode is released.
Remarks	

● Presumed cause of the failure or the error condition

1. Poor connection of connector
2. Wiring failure of the wire-harness
3. Intake throttle position sensor failure
4. ECU internal circuit failure

● Diagnosis

1. Initial diagnosis using SA-D	<ul style="list-style-type: none">• Check the fault indication.• Check the sensor voltage. <p>* See Chapter 2 P337 for details on the diagnosis method and procedure.</p>
---------------------------------	--

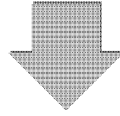

2. Connector/wiring check	<ul style="list-style-type: none">• Before beginning your work, be sure to turn off the ECU power.• Check the connector pin of the intake throttle position sensor for deformation and cracks, the condition of the connection, and whether the retainer is loose or removed.• Make sure that the intake throttle position sensor wiring is not cut or the wiring coating is not peeled.
---------------------------	--

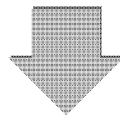

3. Failure diagnosis	<ul style="list-style-type: none">• Check the intake throttle position sensor resistance value.• Check the conduction of the wire-harness.• Check the intake throttle position sensor output voltage. <p>* See Chapter 2 P337 for details on the diagnosis method and procedure.</p>
----------------------	--

P02E8: Intake throttle position sensor error (voltage low)

P code	P02E8	Name	Intake throttle position sensor error (voltage low)
SPN/FMI	51/4		

● **DTC detection criteria**

1. Prerequisite, 2. Judgment criteria	Check points
1. No prerequisite. 2. Sensor output is lower than threshold 0.2 V.	Connector Wire-harness Intake throttle position sensor ECU

● **Actions when an error occurs**

Fault mode	[Limited operation]: Intake throttle position is set to 100% as the default value. The engine operation is limited.
Limited operation	Yes: <ul style="list-style-type: none"> • When sensor error occurs, rated output of the engine is reduced immediately. • The maximum engine torque is limited to 85%. • EGR fully closes. • Intake throttle fully opens. • DPF regeneration stops. • Rated output of the engine is reduced further after 120 min. • The maximum engine torque is limited to 50%.
Reset criteria	Yes: When the ECU power is turned off, the fault mode is released.
Remarks	

● **Presumed cause of the failure or the error condition**

1. Poor connection of connector
2. Wiring failure of the wire-harness
3. Intake throttle position sensor failure
4. ECU internal circuit failure

● **Diagnosis**

1. Initial diagnosis using SA-D	<ul style="list-style-type: none"> • Check the fault indication. • Check the sensor voltage. <p>* See Chapter 2 P337 for details on the diagnosis method and procedure.</p>
---------------------------------	---

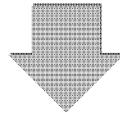

2. Connector/wiring check	<ul style="list-style-type: none"> • Before beginning your work, be sure to turn off the ECU power. • Check the connector pin of the intake throttle position sensor for deformation and cracks, the condition of the connection, and whether the retainer is loose or removed. • Make sure that the intake throttle position sensor wiring is not cut or the wiring coating is not peeled.
---------------------------	--

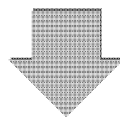

3. Failure diagnosis	<ul style="list-style-type: none"> • Check the intake throttle position sensor resistance value. • Check the conduction of the wire-harness. • Check the intake throttle position sensor output voltage. <p>* See Chapter 2 P337 for details on the diagnosis method and procedure.</p>
----------------------	--

■ EGR low pressure side pressure sensor

P0238: EGR low pressure side pressure sensor error (voltage high)

P code	P0238	Name	EGR low pressure side pressure sensor error (voltage high)
SPN/FMI	102/3		

● DTC detection criteria

1. Prerequisite, 2. Judgment criteria	Check points
1. No prerequisite. 2. Sensor output is higher than threshold 4.8 V.	Connector Wire-harness EGR pressure sensor ECU

● Actions when an error occurs

Fault mode	[Limited operation]: EGR low pressure side pressure is set to 900 hPa as the default value. The engine operation is limited.
Limited operation	Yes: <ul style="list-style-type: none"> • When sensor error occurs, rated output of the engine is reduced immediately. • The maximum engine torque is limited to 85%. • The engine speed is limited to the [maximum torque speed +200 min⁻¹]. • EGR fully closes. • DPF regeneration stops. • The accumulated PM amount calculation by DPF differential pressure stops. • Ash amount reset is prohibited. • Rated output of the engine is reduced further after 15 min. • The maximum engine torque is limited to 50%. • The engine speed is limited to the [maximum torque speed +200 min⁻¹]. • Simultaneous to the above operating restrictions, engine operation restrictions are applied according to the inducement level of the EGR system abnormality. The level of restriction applied will whichever level is higher. <ul style="list-style-type: none"> a. Warning <ul style="list-style-type: none"> When engine operation time is less than 36 hours since abnormality occurred. In this case, restrictions on engine speed/fuel injection quantity vary depending on the error. b. Inducement (Low level) <ul style="list-style-type: none"> When engine operation time 36 hours or more and less than 100 hours from error occurrences (or less than 5 hours (*1)), Inducement level becomes Low level. In this case, the torque is limited to 75%. (For some errors, the engine speed is restricted to low idle and the maximum fuel injection quantity is restricted to 50%.) c. Inducement (Severe level) <ul style="list-style-type: none"> When engine operation time is 100 hours or more from error occurrences (or 5 hours or more (*1)), Inducement level becomes Severe level. In this case, the engine speed is restricted to 60% of its rated speed (in some engine models), and the torque is restricted to 50%. (For some errors, the engine speed is restricted to low idle and the maximum fuel injection quantity is restricted to 50%.) (*1) This time indicates a case when another abnormality that results in inducement occurs within 40 hours of recovery from a previous abnormality.
Reset criteria	Yes: Reset criteria: (sensor output is lower than the 4.8 V threshold) the fault mode is automatically released.
Remarks	

● Presumed cause of the failure or the error condition

1. Poor connection of connector
2. Wiring failure of the wire-harness
 - GND short circuit of the sensor signal wire
3. EGR pressure sensor failure
 - Sensor output failure caused by a GND short circuit of the EGR pressure sensor internal wiring
4. ECU internal circuit failure

● Diagnosis

1. Initial diagnosis using SA-D	<ul style="list-style-type: none"> • Check the fault indication. • Check the sensor voltage. <p>* See Chapter 2 <i>P340</i> for details on the diagnosis method and procedure.</p>
---------------------------------	--

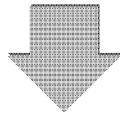

2. Connector/wiring check	<ul style="list-style-type: none"> • Before beginning your work, be sure to turn off the ECU power. • Check the pin of the EGR pressure sensor for deformation and cracks, the condition of the connection, and whether the retainer is removed. • Make sure that the EGR pressure sensor wiring is not cut or the wiring coating is not peeled.
---------------------------	---

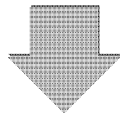

3. Failure diagnosis	<ul style="list-style-type: none"> • Check the conduction of the wire-harness. • Check the EGR pressure sensor output voltage. <p>* See Chapter 2 <i>P340</i> for details on the diagnosis method and procedure.</p>
----------------------	--

P0237: EGR low pressure side pressure sensor error (voltage low)

P code	P0237	Name	EGR low pressure side pressure sensor error (voltage low)
SPN/FMI	102/4		

● DTC detection criteria

1. Prerequisite, 2. Judgment criteria	Check points
1. No prerequisite. 2. Sensor output is lower than threshold 0.2 V.	Connector Wire-harness EGR pressure sensor ECU

● Actions when an error occurs

Fault mode	[Limited operation]: EGR low pressure side pressure is set to 900 hPa as the default value. The engine operation is limited.
Limited operation	Yes: <ul style="list-style-type: none"> • When sensor error occurs, rated output of the engine is reduced immediately. • The maximum engine torque is limited to 85%. • The engine speed is limited to the [maximum torque speed +200 min⁻¹]. • EGR fully closes. • DPF regeneration stops. • The accumulated PM amount calculation by DPF differential pressure stops. • Ash amount reset is prohibited. • Rated output of the engine is reduced further after 15 min. • The maximum engine torque is limited to 50%. • The engine speed is limited to the [maximum torque speed +200 min⁻¹]. • Simultaneous to the above operating restrictions, engine operation restrictions are applied according to the inducement level of the EGR system abnormality. The level of restriction applied will whichever level is higher. <ul style="list-style-type: none"> a. Warning <ul style="list-style-type: none"> When engine operation time is less than 36 hours since abnormality occurred. In this case, restrictions on engine speed/fuel injection quantity vary depending on the error. b. Inducement (Low level) <ul style="list-style-type: none"> When engine operation time 36 hours or more and less than 100 hours from error occurrences (or less than 5 hours (*1)), Inducement level becomes Low level. In this case, the torque is limited to 75%. (For some errors, the engine speed is restricted to low idle and the maximum fuel injection quantity is restricted to 50%.) c. Inducement (Severe level) <ul style="list-style-type: none"> When engine operation time is 100 hours or more from error occurrences (or 5 hours or more (*1)), Inducement level becomes Severe level. In this case, the engine speed is restricted to 60% of its rated speed (in some engine models), and the torque is restricted to 50%. (For some errors, the engine speed is restricted to low idle and the maximum fuel injection quantity is restricted to 50%.) (*1) This time indicates a case when another abnormality that results in inducement occurs within 40 hours of recovery from a previous abnormality.
Reset criteria	Yes: Reset criteria: (sensor output is lower than the 0.2 V threshold) the fault mode is automatically released.
Remarks	

● **Presumed cause of the failure or the error condition**

1. Poor connection of connector
2. Wiring failure of the wire-harness
3. EGR pressure sensor failure
4. ECU internal circuit failure

● **Diagnosis**

1. Initial diagnosis using SA-D	<ul style="list-style-type: none"> • Check the fault indication. • Check the sensor voltage. <p>* See Chapter 2 <i>P340</i> for details on the diagnosis method and procedure.</p>
---------------------------------	--

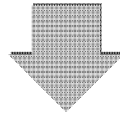

2. Connector/wiring check	<ul style="list-style-type: none"> • Before beginning your work, be sure to turn off the ECU power. • Check the pin of the EGR pressure sensor for deformation and cracks, the condition of the connection, and whether the retainer is removed. • Make sure that the EGR pressure sensor wiring is not cut or the wiring coating is not peeled.
---------------------------	---

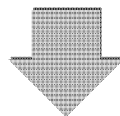

3. Failure diagnosis	<ul style="list-style-type: none"> • Check the conduction of the wire-harness. • Check the EGR pressure sensor output voltage. <p>* See Chapter 2 <i>P340</i> for details on the diagnosis method and procedure.</p>
----------------------	--

P0236: EGR low pressure side pressure sensor error (abnormal learning value)

P code	P0236	Name	EGR low pressure side pressure sensor error (abnormal learning value)
SPN/FMI	102/13		

● **DTC detection criteria**

1. Prerequisite, 2. Judgment criteria	Check points
<p>1. Before engine startup is completed.</p> <ul style="list-style-type: none"> • Atmospheric pressure sensor voltage is normal. • EGR low-pressure side sensor voltage is normal. • Atmospheric pressure characteristics do not fall into problem. <p>* The above conditions are prerequisites for the calculation of the final offset value of intake manifold pressure.</p> <p>2. The final offset value of the intake manifold pressure is less than the threshold value. Or, the final offset value of the intake manifold pressure is greater than the threshold value.</p>	

● **Actions when an error occurs**

Fault mode	[Limited operation]: The engine operation is limited.
Limited operation	<p>Yes: • When sensor error occurs, rated output of the engine is reduced immediately.</p> <ul style="list-style-type: none"> • The maximum engine torque is limited to 85%. • The engine speed is limited to the [maximum torque speed +200 min⁻¹]. • EGR fully closes. • DPF regeneration stops. • The accumulated PM amount calculation by DPF differential pressure stops. • Ash amount reset is prohibited. • Rated output of the engine is reduced further after 15 min. • The maximum engine torque is limited to 50%. • The engine speed is limited to the [maximum torque speed +200 min⁻¹]. <p>• Simultaneous to the above operating restrictions, engine operation restrictions are applied according to the inducement level of the EGR system abnormality. The level of restriction applied will whichever level is higher.</p> <ul style="list-style-type: none"> a. Warning When engine operation time is less than 36 hours since abnormality occurred. In this case, restrictions on engine speed/fuel injection quantity vary depending on the error. b. Inducement (Low level) When engine operation time 36 hours or more and less than 100 hours from error occurrences (or less than 5 hours (*1)), Inducement level becomes Low level. In this case, the torque is limited to 75%. (For some errors, the engine speed is restricted to low idle and the maximum fuel injection quantity is restricted to 50%.) c. Inducement (Severe level) When engine operation time is 100 hours or more from error occurrences (or 5 hours or more (*1)), Inducement level becomes Severe level. In this case, the engine speed is restricted to 60% of its rated speed (in some engine models), and the torque is restricted to 50%. (For some errors, the engine speed is restricted to low idle and the maximum fuel injection quantity is restricted to 50%.) <p>(*1) This time indicates a case when another abnormality that results in inducement occurs within 40 hours of recovery from a previous abnormality.</p>
Reset criteria	Yes: When the ECU power is turned off, the fault mode is released.
Remarks	

● Presumed cause of the failure or the error condition

1. Poor connection of connector
2. Wiring failure of the wire-harness
3. EGR pressure sensor failure
4. ECU internal circuit failure

● Diagnosis

1. Initial diagnosis using SA-D	<ul style="list-style-type: none">• Check the fault indication.• Check the sensor voltage. <p>* See Chapter 2 <i>P340</i> for details on the diagnosis method and procedure.</p>
---------------------------------	---

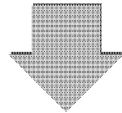

2. Connector/wiring check	<ul style="list-style-type: none">• Before beginning your work, be sure to turn off the ECU power.• Check the pin of the EGR pressure sensor for deformation and cracks, the condition of the connection, and whether the retainer is removed.• Make sure that the EGR pressure sensor wiring is not cut or the wiring coating is not peeled.
---------------------------	---

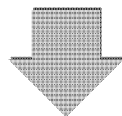

3. Failure diagnosis	<ul style="list-style-type: none">• Check the conduction of the wire-harness.• Check the EGR pressure sensor output voltage. <p>* See Chapter 2 <i>P340</i> for details on the diagnosis method and procedure.</p>
----------------------	---

P1673: EGR low pressure side pressure sensor error (detected value error)

P code	P1673	Name	EGR low pressure side pressure sensor error (detected value error)
SPN/FMI	102/10		

● **Purpose of DTC detection**

When the pressure difference between the intake manifold pressure at engine stop and intake manifold pressure while engine is running is small, this error is detected. This detects errors such as the EGR low pressure side pressure sensor falling off from the engine.

● **DTC detection criteria**

1. Prerequisite, 2. Judgment criteria	Check points
1. The following prerequisites should be satisfied: <ul style="list-style-type: none"> • No abnormalities in related sensors • Battery voltage is within the prescribed range • Not during forced operation by service tool • During engine operation • Not during DPF regeneration • Atmospheric pressure is 82.3 kPa or more • Current injection amount is equal to or more than the predetermined value determine by the engine rpm 2. After the prerequisite conditions have been established for set period of time, the difference between the pressure on the EGR low pressure side (after learning) and the atmospheric pressure shall be within the prescribed range.	Connector Wire-harness EGR pressure sensor ECU

● **Actions when an error occurs**

Fault mode	[Limited operation]: The engine operation is limited.
Limited operation	Yes: • When a sensor abnormality occurs, engine operation restrictions are applied according to the inducement level of the EGR system abnormality. <ul style="list-style-type: none"> a. Warning When engine operation time is less than 36 hours since abnormality occurred. In this case, restrictions on engine speed/fuel injection quantity vary depending on the error. b. Inducement (Low level) When engine operation time 36 hours or more and less than 100 hours from error occurrences (or less than 5 hours (*1)), Inducement level becomes Low level. At this time, the engine torque is limited to 75 % (the engine speed is limited to low idle speed in some errors while the maximum fuel injection quantity is limited to 50%.) c. Inducement (Severe level) When engine operation time is 100 hours or more from error occurrences (or 5 hours or more (*1)), Inducement level becomes Severe level. In this case, the engine speed is limited to 60% of its rated speed (in some engine models), and the torque is limited to 50%. (For some errors, the engine speed is restricted to low idle and the maximum fuel injection quantity is restricted to 50%.) (*1) This time indicates a case when another abnormality that results in inducement occurs within 40 hours of recovery from a previous abnormality.
Reset criteria	Yes: After the reset conditions (specified period of time has elapsed since prerequisites satisfied, and detection conditions not established) are satisfied, automatic reset occurs.
Remarks	

● **Presumed cause of the failure or the error condition**

1. Installation failure of EGR pressure sensor
2. Poor connection of connector
3. Wiring failure of the wire-harness
4. EGR pressure sensor failure
5. ECU internal circuit failure

● **Diagnosis**

1. Initial diagnosis using SA-D	<ul style="list-style-type: none"> • Check the fault indication. <p>* See Chapter 2 P343 for details on the diagnosis method and procedure.</p>
---------------------------------	--

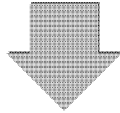

2. Engine check	<ul style="list-style-type: none"> • Before beginning your work, be sure to turn off the key switch, and turn off the ECU power. • Check the installation condition of EGR pressure sensor. • Make sure that there is nothing wrong (disconnections and damages) with the exhaust piping, pressure hose, or pressure pipe.
-----------------	---

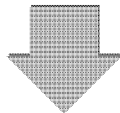

3. Connector/wiring check	<ul style="list-style-type: none"> • Check the pin of the EGR pressure sensor for deformation and cracks, the condition of the connection, and whether the retainer is loose or removed. • Make sure that the EGR pressure sensor wiring is not cut or the wiring coating is not peeled.
---------------------------	--

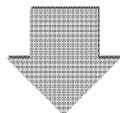

4. Failure diagnosis	<ul style="list-style-type: none"> • Check the ECU output voltage. • Check the EGR low pressure side pressure sensor output voltage. • Check the conduction of the wire-harness. <p>* See Chapter 2 P343 for details on the diagnosis method and procedure.</p>
----------------------	--

■ EGR high pressure side pressure sensor

P0473: EGR high pressure side pressure sensor error (voltage high)

P code	P0473	Name	EGR high pressure side pressure sensor error (voltage high)
SPN/FMI	1209/3		

● DTC detection criteria

1. Prerequisite, 2. Judgment criteria	Check points
1. No prerequisite. 2. Sensor output is higher than threshold 4.8 V.	Connector Wire-harness EGR pressure sensor ECU

● Actions when an error occurs

Fault mode	[Limited operation]: EGR high pressure side pressure is set to 900 hPa as the default value. The engine operation is limited.
Limited operation	Yes: <ul style="list-style-type: none"> • When sensor error occurs, rated output of the engine is reduced immediately. • The maximum engine torque is limited to 85%. • The engine speed is limited to the [maximum torque speed +200 min⁻¹]. • EGR fully closes. • Ash amount reset is prohibited. • Rated output of the engine is reduced further after 15 min. • The maximum engine torque is limited to 50%. • The engine speed is limited to the [maximum torque speed +200 min⁻¹]. • Simultaneous to the above operating restrictions, engine operation restrictions are applied according to the inducement level of the EGR system abnormality. The level of restriction applied will whichever level is higher. <ul style="list-style-type: none"> a. Warning <p>When engine operation time is less than 36 hours since abnormality occurred.</p> <p>In this case, restrictions on engine speed/fuel injection quantity vary depending on the error.</p> b. Inducement (Low level) <p>When engine operation time 36 hours or more and less than 100 hours from error occurrences (or less than 5 hours (*1)), Inducement level becomes Low level. In this case, the torque is limited to 75%.</p> <p>(For some errors, the engine speed is restricted to low idle and the maximum fuel injection quantity is restricted to 50%.)</p> c. Inducement (Severe level) <p>When engine operation time is 100 hours or more from error occurrences (or 5 hours or more (*1)), Inducement level becomes Severe level. In this case, the engine speed is restricted to 60% of its rated speed (in some engine models), and the torque is restricted to 50%.</p> <p>(For some errors, the engine speed is restricted to low idle and the maximum fuel injection quantity is restricted to 50%.)</p> <p>(*1) This time indicates a case when another abnormality that results in inducement occurs within 40 hours of recovery from a previous abnormality.</p>
Reset criteria	Yes: Reset criteria: (sensor output is lower than the 4.8 V threshold) the fault mode is automatically released.
Remarks	

● **Presumed cause of the failure or the error condition**

1. Poor connection of connector
2. Wiring failure of the wire-harness
3. EGR pressure sensor failure
4. ECU internal circuit failure

● **Diagnosis**

1. Initial diagnosis using SA-D	<ul style="list-style-type: none"> • Check the fault indication. • Check the sensor voltage. <p>* See Chapter 2 <i>P348</i> for details on the diagnosis method and procedure.</p>
---------------------------------	--

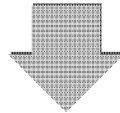

2. Connector/wiring check	<ul style="list-style-type: none"> • Before beginning your work, be sure to turn off the ECU power. • Check the pin of the EGR pressure sensor for deformation and cracks, the condition of the connection, and whether the retainer is removed. • Make sure that the EGR pressure sensor wiring is not cut or the wiring coating is not peeled.
---------------------------	---

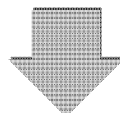

3. Failure diagnosis	<ul style="list-style-type: none"> • Check the conduction of the wire-harness. • Check the EGR pressure sensor output voltage. <p>* See Chapter 2 <i>P348</i> for details on the diagnosis method and procedure.</p>
----------------------	--

P0472: EGR high pressure side pressure sensor error (voltage low)

P code	P0472	Name	EGR high pressure side pressure sensor error (voltage low)
SPN/FMI	1209/4		

● DTC detection criteria

1. Prerequisite, 2. Judgment criteria	Check points
1. No prerequisite. 2. Sensor output is lower than threshold 0.2 V.	Connector Wire-harness EGR pressure sensor ECU

● Actions when an error occurs

Fault mode	[Limited operation]: EGR high pressure side pressure is set to 900 hPa as the default value. The engine operation is limited.
Limited operation	Yes: <ul style="list-style-type: none"> • When sensor error occurs, rated output of the engine is reduced immediately. • The maximum engine torque is limited to 85%. • The engine speed is limited to the [maximum torque speed +200 min⁻¹]. • EGR fully closes. • Ash amount reset is prohibited. • Rated output of the engine is reduced further after 15 min. • The maximum engine torque is limited to 50%. • The engine speed is limited to the [maximum torque speed +200 min⁻¹]. • Simultaneous to the above operating restrictions, engine operation restrictions are applied according to the inducement level of the EGR system abnormality. The level of restriction applied will whichever level is higher. <ul style="list-style-type: none"> a. Warning <ul style="list-style-type: none"> When engine operation time is less than 36 hours since abnormality occurred. In this case, restrictions on engine speed/fuel injection quantity vary depending on the error. b. Inducement (Low level) <ul style="list-style-type: none"> When engine operation time 36 hours or more and less than 100 hours from error occurrences (or less than 5 hours (*1)), Inducement level becomes Low level. In this case, the torque is limited to 75%. (For some errors, the engine speed is restricted to low idle and the maximum fuel injection quantity is restricted to 50%.) c. Inducement (Severe level) <ul style="list-style-type: none"> When engine operation time is 100 hours or more from error occurrences (or 5 hours or more (*1)), Inducement level becomes Severe level. In this case, the engine speed is restricted to 60% of its rated speed (in some engine models), and the torque is restricted to 50%. (For some errors, the engine speed is restricted to low idle and the maximum fuel injection quantity is restricted to 50%.) (*1) This time indicates a case when another abnormality that results in inducement occurs within 40 hours of recovery from a previous abnormality.
Reset criteria	Yes: Reset criteria: (sensor output is lower than the 0.2 V threshold) the fault mode is automatically released.
Remarks	

● **Presumed cause of the failure or the error condition**

1. Poor connection of connector
2. Wiring failure of the wire-harness
3. EGR pressure sensor failure
4. ECU internal circuit failure

● **Diagnosis**

1. Initial diagnosis using SA-D	<ul style="list-style-type: none"> • Check the fault indication. • Check the sensor voltage. <p>* See Chapter 2 <i>P348</i> for details on the diagnosis method and procedure.</p>
---------------------------------	--

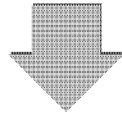

2. Connector/wiring check	<ul style="list-style-type: none"> • Before beginning your work, be sure to turn off the ECU power. • Check the pin of the EGR pressure sensor for deformation and cracks, the condition of the connection, and whether the retainer is removed. • Make sure that the EGR pressure sensor wiring is not cut or the wiring coating is not peeled.
---------------------------	---

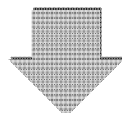

3. Failure diagnosis	<ul style="list-style-type: none"> • Check the conduction of the wire-harness. • Check the EGR pressure sensor output voltage. <p>* See Chapter 2 <i>P348</i> for details on the diagnosis method and procedure.</p>
----------------------	--

P0471: EGR high pressure side pressure sensor error (abnormal learning value)

P code	P0471	Name	EGR high pressure side pressure sensor error (abnormal learning value)
SPN/FMI	1209/13		

● **DTC detection criteria**

1. Prerequisite, 2. Judgment criteria	Check points
<p>1. Before engine startup is completed.</p> <ul style="list-style-type: none"> • Atmospheric pressure sensor voltage is normal. • EGR low-pressure side sensor voltage is normal. • Atmospheric pressure characteristics do not fall into problem. <p>* The above conditions are prerequisites for the calculation of the final offset value of intake manifold pressure.</p> <p>2. The final offset value of the exhaust manifold pressure is less than the threshold value. Or, the final offset value of the exhaust manifold pressure is greater than the threshold value.</p>	

● **Actions when an error occurs**

Fault mode	[Limited operation]: The engine operation is limited.
Limited operation	<p>Yes:</p> <ul style="list-style-type: none"> • When sensor error occurs, rated output of the engine is reduced immediately. <ul style="list-style-type: none"> • The maximum engine torque is limited to 85%. • The engine speed is limited to the [maximum torque speed +200 min⁻¹]. • EGR fully closes. • Ash amount reset is prohibited. • Rated output of the engine is reduced further after 15 min. • The maximum engine torque is limited to 50%. • The engine speed is limited to the [maximum torque speed +200 min⁻¹]. • Simultaneous to the above operating restrictions, engine operation restrictions are applied according to the inducement level of the EGR system abnormality. The level of restriction applied will whichever level is higher. <ul style="list-style-type: none"> a. Warning <ul style="list-style-type: none"> When engine operation time is less than 36 hours since abnormality occurred. In this case, restrictions on engine speed/fuel injection quantity vary depending on the error. b. Inducement (Low level) <ul style="list-style-type: none"> When engine operation time 36 hours or more and less than 100 hours from error occurrences (or less than 5 hours (*1)), Inducement level becomes Low level. In this case, the torque is limited to 75%. (For some errors, the engine speed is restricted to low idle and the maximum fuel injection quantity is restricted to 50%.) c. Inducement (Severe level) <ul style="list-style-type: none"> When engine operation time is 100 hours or more from error occurrences (or 5 hours or more (*1)), Inducement level becomes Severe level. In this case, the engine speed is restricted to 60% of its rated speed (in some engine models), and the torque is restricted to 50%. (For some errors, the engine speed is restricted to low idle and the maximum fuel injection quantity is restricted to 50%.) <p>(*1) This time indicates a case when another abnormality that results in inducement occurs within 40 hours of recovery from a previous abnormality.</p>
Reset criteria	Yes: When the ECU power is turned off, the fault mode is released.
Remarks	

● Presumed cause of the failure or the error condition

1. Poor connection of connector
2. Wiring failure of the wire-harness
3. EGR pressure sensor failure
4. ECU internal circuit failure

● Diagnosis

1. Initial diagnosis using SA-D	<ul style="list-style-type: none"> • Check the fault indication. • Check the sensor voltage. <p>* See Chapter 2 <i>P348</i> for details on the diagnosis method and procedure.</p>
---------------------------------	--

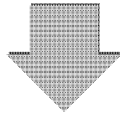

2. Connector/wiring check	<ul style="list-style-type: none"> • Before beginning your work, be sure to turn off the ECU power. • Check the pin of the EGR pressure sensor for deformation and cracks, the condition of the connection, and whether the retainer is removed. • Make sure that the EGR pressure sensor wiring is not cut or the wiring coating is not peeled.
---------------------------	---

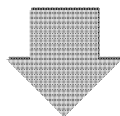

3. Failure diagnosis	<ul style="list-style-type: none"> • Check the conduction of the wire-harness. • Check the EGR pressure sensor output voltage. <p>* See Chapter 2 <i>P348</i> for details on the diagnosis method and procedure.</p>
----------------------	--

P1679: EGR high pressure side pressure sensor error (detected value error)

P code	P1679	Name	EGR high pressure side pressure sensor error (detected value error)
SPN/FMI	1209/10		

● **DTC detection criteria**

1. Prerequisite, 2. Judgment criteria	Check points
<p>1. The following prerequisites should be satisfied:</p> <ul style="list-style-type: none"> • No abnormalities in related sensors • Battery voltage is within the prescribed range • Not during forced operation by service tool • During engine operation • Not during DPF regeneration • Atmospheric pressure is 82.3 kPa or more • Current injection amount is equal to or more than the predetermined value determine by the engine rpm <p>2. After the prerequisite conditions have been established for 5 continual seconds, the difference between the pressure on the EGR high pressure side (after learning) and the atmospheric pressure shall be 0.4 kPa or less.</p>	<p>Connector Wire-harness EGR pressure sensor ECU</p>

● **Actions when an error occurs**

Fault mode	[Limited operation]: EGR high pressure side pressure is set to 90 kPa as the default value. The engine operation is limited.
Limited operation	<p>Yes: • When a sensor abnormality occurs, engine operation restrictions are applied according to the inducement level of the EGR system abnormality.</p> <p>a. Warning When engine operation time is less than 36 hours since abnormality occurred. In this case, restrictions on engine speed/fuel injection quantity vary depending on the error.</p> <p>b. Inducement (Low level) When engine operation time 36 hours or more and less than 100 hours from error occurrences (or less than 5 hours (*1)), Inducement level becomes Low level. At this time, the engine torque is limited to 75% (the engine speed is limited to low idle speed in some errors while the maximum fuel injection quantity is limited to 50%.)</p> <p>c. Inducement (Severe level) When engine operation time is 100 hours or more from error occurrences (or 5 hours or more (*1)), Inducement level becomes Severe level. In this case, the engine speed is limited to 60% of its rated speed (in some engine models), and the torque is limited to 50%. (For some errors, the engine speed is restricted to low idle and the maximum fuel injection quantity is restricted to 50%.)</p> <p>(*1) This time indicates a case when another abnormality that results in inducement occurs within 40 hours of recovery from a previous abnormality.</p>
Reset criteria	Yes: After the reset conditions have been established for 5 continual seconds, (prerequisites satisfied for 5 continual seconds, detection conditions not established) automatic reset occurs.
Remarks	

● **Presumed cause of the failure or the error condition**

1. Poor connection of connector
2. Wiring failure of the wire-harness
 - GND short circuit of the sensor signal wire
3. EGR pressure sensor failure
 - Sensor output failure caused by a GND short circuit of the EGR pressure sensor internal wiring
4. ECU internal circuit failure

● **Diagnosis**

1. Initial diagnosis using SA-D	<ul style="list-style-type: none"> • Check the fault indication. • Check the sensor voltage. <p>* See Chapter 2 <i>P348</i> for details on the diagnosis method and procedure.</p>
---------------------------------	--

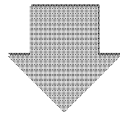

2. Connector/wiring check	<ul style="list-style-type: none"> • Before beginning your work, be sure to turn off the ECU power. • Check the pin of the EGR pressure sensor for deformation and cracks, the condition of the connection, and whether the retainer is loose or removed. • Make sure that the EGR pressure sensor wiring is not cut or the wiring coating is not peeled.
---------------------------	--

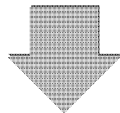

3. Failure diagnosis	<ul style="list-style-type: none"> • Check the EGR pressure sensor resistance value. • Check the conduction of the wire-harness. • Check the EGR pressure sensor output voltage. <p>* See Chapter 2 <i>P348</i> for details on the diagnosis method and procedure.</p>
----------------------	---

■ Engine coolant temperature sensor

P0118: Engine coolant temperature sensor error (voltage high)

P code	P0118	Name	Engine coolant temperature sensor error (voltage high)
SPN/FMI	110/3		

● DTC detection criteria

1. Prerequisite, 2. Judgment criteria	Check points
1. No prerequisite. 2. Sensor output is higher than threshold 4.8 V.	Connector Wire-harness Engine coolant temperature sensor ECU

● Actions when an error occurs

Fault mode	[Limited operation]: The engine coolant temperature is set to -15 °C at engine start and 50 °C after starting the engine as the default value. The engine operation is limited.
Limited operation	Yes: <ul style="list-style-type: none"> • When sensor error occurs, rated output of the engine is reduced immediately. • The maximum engine torque is limited to 85%. • EGR fully closes. • Ash amount reset is prohibited. • Rated output of the engine is reduced further after 120 min. • The maximum engine torque is limited to 50%. • Simultaneous to the above operating restrictions, engine operation restrictions are applied according to the inducement level of the EGR system abnormality. The level of restriction applied will whichever level is higher. <ul style="list-style-type: none"> a. Warning <ul style="list-style-type: none"> When engine operation time is less than 36 hours since abnormality occurred. In this case, restrictions on engine speed/fuel injection quantity vary depending on the error. b. Inducement (Low level) <ul style="list-style-type: none"> When engine operation time 36 hours or more and less than 100 hours from error occurrences (or less than 5 hours (*1)), Inducement level becomes Low level. In this case, the torque is limited to 75%. (For some errors, the engine speed is restricted to low idle and the maximum fuel injection quantity is restricted to 50%.) c. Inducement (Severe level) <ul style="list-style-type: none"> When engine operation time is 100 hours or more from error occurrences (or 5 hours or more (*1)), Inducement level becomes Severe level. In this case, the engine speed is restricted to 60% of its rated speed (in some engine models), and the torque is restricted to 50%. (For some errors, the engine speed is restricted to low idle and the maximum fuel injection quantity is restricted to 50%.) (*1) This time indicates a case when another abnormality that results in inducement occurs within 40 hours of recovery from a previous abnormality.
Reset criteria	Yes: Reset criteria: (sensor output is lower than the 4.8 V threshold) the fault mode is automatically released.
Remarks	

● **Presumed cause of the failure or the error condition**

1. Poor connection of connector
2. Wiring failure of the wire-harness
 - Disconnection or power short circuit of the sensor GND wire
 - Disconnection or power short circuit of the sensor signal wire
3. Engine coolant temperature sensor failure
 - Sensor output failure caused by an disconnection of the engine coolant temperature sensor internal wiring
4. ECU internal circuit failure

● **Diagnosis**

1. Initial diagnosis using SA-D	<ul style="list-style-type: none"> • Check the fault indication. • Check the sensor voltage. <p>* See Chapter 2 P351 for details on the diagnosis method and procedure.</p>
---------------------------------	---

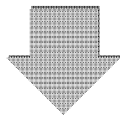

2. Connector/wiring check	<ul style="list-style-type: none"> • Before beginning your work, turn off the ECU power. • Check the pin of the engine coolant temperature sensor for deformation and cracks, the condition of the connection, and whether the retainer is loose or removed. • Make sure that the engine coolant temperature sensor wiring is not cut or the wiring coating is not peeled.
---------------------------	---

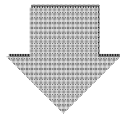

3. Failure diagnosis	<ul style="list-style-type: none"> • Check the engine coolant temperature sensor resistance value. • Check the conduction of the wire-harness. • Check the engine coolant temperature sensor output voltage. <p>* See Chapter 2 P351 for details on the diagnosis method and procedure.</p>
----------------------	--

P0117: Engine coolant temperature sensor error (voltage low)

P code	P0117	Name	Engine coolant temperature sensor error (voltage low)
SPN/FMI	110/4		

● DTC detection criteria

1. Prerequisite, 2. Judgment criteria	Check points
1. No prerequisite. 2. Sensor output is lower than threshold 0.2 V.	Connector Wire-harness Engine coolant temperature sensor ECU

● Actions when an error occurs

Fault mode	[Limited operation]: The engine coolant temperature is set to -15 °C at engine start and 50 °C after starting the engine as the default value. The engine operation is limited.
Limited operation	Yes: <ul style="list-style-type: none"> • When sensor error occurs, rated output of the engine is reduced immediately. • The maximum engine torque is limited to 85%. • EGR fully closes. • Ash amount reset is prohibited. • Rated output of the engine is reduced further after 120 min. • The maximum engine torque is limited to 50%. • Simultaneous to the above operating restrictions, engine operation restrictions are applied according to the inducement level of the EGR system abnormality. The level of restriction applied will whichever level is higher. <ul style="list-style-type: none"> a. Warning <ul style="list-style-type: none"> When engine operation time is less than 36 hours since abnormality occurred. In this case, restrictions on engine speed/fuel injection quantity vary depending on the error. b. Inducement (Low level) <ul style="list-style-type: none"> When engine operation time 36 hours or more and less than 100 hours from error occurrences (or less than 5 hours (*1)), Inducement level becomes Low level. In this case, the torque is limited to 75%. (For some errors, the engine speed is restricted to low idle and the maximum fuel injection quantity is restricted to 50%.) c. Inducement (Severe level) <ul style="list-style-type: none"> When engine operation time is 100 hours or more from error occurrences (or 5 hours or more (*1)), Inducement level becomes Severe level. In this case, the engine speed is restricted to 60% of its rated speed (in some engine models), and the torque is restricted to 50%. (For some errors, the engine speed is restricted to low idle and the maximum fuel injection quantity is restricted to 50%.) (*1) This time indicates a case when another abnormality that results in inducement occurs within 40 hours of recovery from a previous abnormality.
Reset criteria	Yes: Reset criteria: (sensor output is lower than the 0.2 V threshold) the fault mode is automatically released.
Remarks	

● Presumed cause of the failure or the error condition

1. Poor connection of connector
2. Wiring failure of the wire-harness
 - GND short circuit of the sensor signal wire
3. Engine coolant temperature sensor failure
 - Sensor output failure caused by a GND short circuit of the engine coolant temperature sensor internal wiring
4. ECU internal circuit failure

● Diagnosis

1. Initial diagnosis using SA-D	<ul style="list-style-type: none"> • Check the fault indication. • Check the sensor voltage. <p>* See Chapter 2 P351 for details on the diagnosis method and procedure.</p>
---------------------------------	---

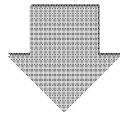

2. Connector/wiring check	<ul style="list-style-type: none"> • Before beginning your work, be sure to turn off the ECU power. • Check the pin of the engine coolant temperature sensor for deformation and cracks, the condition of the connection, and whether the retainer is loose or removed. • Make sure that the engine coolant temperature sensor wiring is not cut or the wiring coating is not peeled.
---------------------------	--

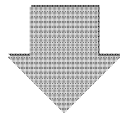

3. Failure diagnosis	<ul style="list-style-type: none"> • Check the engine coolant temperature sensor resistance value. • Check the conduction of the wire-harness. • Check the engine coolant temperature sensor output voltage. <p>* See Chapter 2 P351 for details on the diagnosis method and procedure.</p>
----------------------	--

P1674: Engine coolant temperature sensor error (detected value error)

P code	P1674	Name	Engine coolant temperature sensor error (detected value error)
SPN/FMI	110/10		

● **Purpose of DTC detection**

Compare the engine coolant temperature when the engine stops and while the engine is running. If the temperature difference is small, this error is detected. This detects errors such as the engine coolant temperature sensor falling off from the engine.

● **DTC detection criteria**

1. Prerequisite, 2. Judgment criteria	Check points
<p>1. The following prerequisites should be satisfied:</p> <ul style="list-style-type: none"> • No abnormality in water temperature sensor • Battery voltage is within the prescribed range • The last driving cycle has completely warmed up • The difference between the DPF intermediate temperature and the intake air temperature immediately after turning the key ON is within ± 12.8 °C • Low coolant temperature has caused EGR valve to close completely (coolant temperature is 60 °C or lower) • Atmospheric pressure is 82.3 kPa or more • The intake air temperature immediately after starting is between -7 °C and 35 °C • The engine is operated for 2400 s at an injection amount equal to or more than the predetermined value determined by the engine rpm <p>2. After the prerequisite conditions have been established, the following shall be satisfied:</p> <ul style="list-style-type: none"> • The difference in the current coolant temperature, and the coolant temperature at engine start shall be 40 °C or less 	<p>Connector Wire-harness Engine coolant temperature sensor ECU</p>

● **Actions when an error occurs**

Fault mode	[Limited operation]: The engine operation is limited.
Limited operation	<p>Yes: • When a sensor abnormality occurs, engine operation restrictions are applied according to the inducement level of the EGR system abnormality.</p> <p>a. Warning When engine operation time is less than 36 hours since abnormality occurred. In this case, restrictions on engine speed/fuel injection quantity vary depending on the error.</p> <p>b. Inducement (Low level) When engine operation time 36 hours or more and less than 100 hours from error occurrences (or less than 5 hours (*1)), Inducement level becomes Low level. At this time, the engine torque is limited to 75% (the engine speed is limited to low idle speed in some errors while the maximum fuel injection quantity is limited to 50%.)</p> <p>c. Inducement (Severe level) When engine operation time is 100 hours or more from error occurrences (or 5 hours or more (*1)), Inducement level becomes Severe level. In this case, the engine speed is limited to 60% of its rated speed (in some engine models), and the torque is limited to 50%. (For some errors, the engine speed is restricted to low idle and the maximum fuel injection quantity is restricted to 50%.)</p> <p>(*1) This time indicates a case when another abnormality that results in inducement occurs within 40 hours of recovery from a previous abnormality.</p>
Reset criteria	Yes: After the reset conditions (coolant temperature of 60 °C or above) are satisfied, automatic reset occurs.
Remarks	

● Presumed cause of the failure or the error condition

1. Installation failure of engine coolant temperature sensor
2. Poor connection of connector
3. Wiring failure of the wire-harness
4. Engine coolant temperature sensor failure
5. ECU internal circuit failure

● Diagnosis

1. Initial diagnosis using SA-D	<ul style="list-style-type: none"> • Check the fault indication. <p>* See Chapter 2 P355 for details on the diagnosis method and procedure.</p>
---------------------------------	--

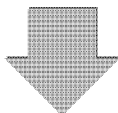

2. Engine check	<ul style="list-style-type: none"> • Before beginning your work, be sure to turn off the key switch, and turn off the ECU power. • Check the installation condition of engine coolant temperature sensor. • Make sure that there is nothing wrong (disconnections and damages) with the engine coolant piping or cooling system.
-----------------	---

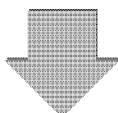

3. Connector/wiring check	<ul style="list-style-type: none"> • Check the pin of the engine coolant temperature sensor for deformation and cracks, the condition of the connection, and whether the retainer is loose or removed. • Make sure that the engine coolant temperature sensor wiring is not cut or the wiring coating is not peeled.
---------------------------	--

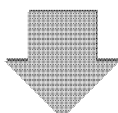

4. Failure diagnosis	<ul style="list-style-type: none"> • Check the engine coolant temperature sensor resistance value. • Check the conduction of the wire-harness. • Check the engine coolant temperature sensor output voltage. <p>* See Chapter 2 P355 for details on the diagnosis method and procedure.</p>
----------------------	--

P0217: Engine coolant temperature high (overheat)

P code	P0217	Name	Engine coolant temperature high (overheat)
SPN/FMI	110/0		

● **DTC detection criteria**

1. Prerequisite, 2. Judgment criteria	Check points
1. The engine coolant temperature sensor is normal, and 60 sec have passed since completion of the engine start. 2. Cooling water temperature 110 °C or above is continued for 20 sec.	Engine cooling water level Engine cooling equipment Engine coolant temperature sensor system

● **Actions when an error occurs**

	Settings of the actions during a "cooling water temperature high" alarm	
	No	Yes
Fault mode	[Continuous operation]: The engine continues to operate without limitations after the error is detected.	[Limited operation]: The engine operation is limited.
Limited operation	No	Yes: • The high idle speed or the maximum injection quantity is limited. (Action differs depending on each customer's settings.) • EGR fully closes.
Reset criteria	Yes: • When the ECU power off is detected, the fault mode is released. • Automatic recovery is made when the cooling water temperature 105 °C or below.	Yes: • When the ECU power off is detected, the fault mode is released. • Automatic recovery is made when the cooling water temperature 105 °C or below continues for 60 sec.
Remarks		

● **Presumed cause of the failure or the error condition**

1. Engine overheat
2. Insufficient engine cooling water
3. Engine cooling equipment failure
4. Engine coolant temperature sensor system failure

● Diagnosis

1. Initial diagnosis using SA-D	<ul style="list-style-type: none">• Check the fault indication. <p>* See Chapter 2 <i>P351</i> for details on the diagnosis method and procedure.</p>
---------------------------------	---

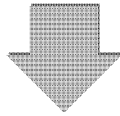

2. Engine check	<ul style="list-style-type: none">• Turn off the ECU power and stop the engine.• Check the engine cooling equipment.• After a few moments, turn on the ECU power and make sure that the DTC is detected.
-----------------	--

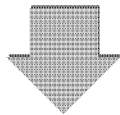

3. Failure diagnosis	<ul style="list-style-type: none">• Check the engine coolant temperature sensor system. <p>* See Chapter 2 <i>P351</i> for details on the diagnosis method and procedure.</p>
----------------------	---

■ Ambient air temperature sensor

P0113: Ambient air temperature sensor error (voltage high)

P code	P0113	Name	Ambient air temperature sensor error (voltage high)
SPN/FMI	172/3		

● DTC detection criteria

1. Prerequisite, 2. Judgment criteria	Check points
1. No prerequisite. 2. Sensor output is higher than threshold 4.85 V.	Connector Wire-harness Ambient air temperature sensor ECU

● Actions when an error occurs

Fault mode	[Limited operation]: The fuel temperature is set to 25 °C as the default value. The engine operation is limited.
Limited operation	Yes: Ash amount reset is prohibited.
Reset criteria	Yes: When the ECU power is turned off, the fault mode is released.
Remarks	

● Presumed cause of the failure or the error condition

1. Poor connection of connector
2. Wiring failure of the wire-harness
 - Disconnection or power short circuit of the sensor GND wire
 - Disconnection or power short circuit of the sensor signal wire
3. Ambient air temperature sensor failure
 - Sensor output failure caused by a disconnection of the ambient air temperature sensor internal wiring
4. ECU internal circuit failure

● **Diagnosis**

1. Initial diagnosis using SA-D	<ul style="list-style-type: none"> • Check the fault indication. • Check the sensor voltage. <p>* See Chapter 2 <i>P360</i> for details on the diagnosis method and procedure.</p>
---------------------------------	--

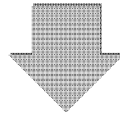

2. Connector/wiring check	<ul style="list-style-type: none"> • Before beginning your work, be sure to turn off the ECU power. • Check the pin of the ambient air temperature sensor for deformation and cracks, the condition of the connection, and whether the retainer is loose or removed. • Make sure that the ambient air temperature sensor wiring is not cut or the wiring coating is not peeled.
---------------------------	--

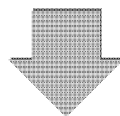

3. Failure diagnosis	<ul style="list-style-type: none"> • Check the resistance value of the ambient air temperature sensor. • Check the conduction of the wire-harness. • Check the output voltage of the ambient air temperature sensor. <p>* See Chapter 2 page <i>P360</i> for details on the diagnosis method and procedure.</p>
----------------------	--

P0112: Ambient air temperature sensor error (voltage low)

P code	P0112	Name	Ambient air temperature sensor error (voltage low)
SPN/FMI	172/4		

● DTC detection criteria

1. Prerequisite, 2. Judgment criteria	Check points
1. No prerequisite. 2. Sensor output is lower than threshold 0.15 V.	Connector Wire-harness Ambient air temperature sensor ECU

● Actions when an error occurs

Fault mode	[Limited operation]: The fuel temperature is set to 25 °C as the default value. The engine operation is limited.
Limited operation	Yes: Ash amount reset is prohibited.
Reset criteria	Yes: When the ECU power is turned off, the fault mode is released.
Remarks	

● Presumed cause of the failure or the error condition

1. Poor connection of connector
2. Wiring failure of the wire-harness
 - GND short circuit of the sensor signal wire
3. Ambient air temperature sensor failure
 - Sensor output failure caused by a GND short circuit of the ambient air temperature sensor internal wiring
4. ECU internal circuit failure

● Diagnosis

1. Initial diagnosis using SA-D	<ul style="list-style-type: none">• Check the fault indication.• Check the sensor voltage. <p>* See Chapter 2 P360 for details on the diagnosis method and procedure.</p>
---------------------------------	--

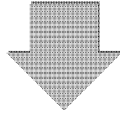

2. Connector/wiring check	<ul style="list-style-type: none">• Before beginning your work, be sure to turn off the ECU power.• Check the pin of the ambient air temperature sensor for deformation and cracks, the condition of the connection, and whether the retainer is loose or removed.• Make sure that the ambient air temperature sensor wiring is not cut or the wiring coating is not peeled.
---------------------------	--

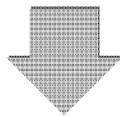

3. Failure diagnosis	<ul style="list-style-type: none">• Check the resistance value of the ambient air temperature sensor.• Check the conduction of the wire-harness.• Check the output voltage of the ambient air temperature sensor. <p>* See Chapter 2 P360 for details on the diagnosis method and procedure.</p>
----------------------	--

■ Fuel temperature sensor

P0183: Fuel temperature sensor error (voltage high)

P code	P0183	Name	Fuel temperature sensor error (voltage high)
SPN/FMI	174/3		

● DTC detection criteria

1. Prerequisite, 2. Judgment criteria	Check points
1. No prerequisite. 2. Sensor output is higher than threshold 4.8 V.	Connector Wire-harness Fuel temperature sensor ECU

● Actions when an error occurs

Fault mode	[Limited operation]: The fuel temperature is set to 40 °C as the default value. The engine operation is limited.
Limited operation	Yes: <ul style="list-style-type: none"> • Ash amount reset is prohibited. • When sensor error occurs, rated output of the engine is reduced immediately. • The maximum engine torque is limited to 85%.
Reset criteria	Yes: When the ECU power is turned off, the fault mode is released.
Remarks	

● Presumed cause of the failure or the error condition

1. Poor connection of connector
2. Wiring failure of the wire-harness
 - Disconnection or power short circuit of the sensor GND wire
 - Disconnection or power short circuit of the sensor signal wire
3. Fuel temperature sensor failure
 - Sensor output failure caused by a disconnection of the fuel temperature sensor internal wiring
4. ECU internal circuit failure

● **Diagnosis**

1. Initial diagnosis using SA-D	<ul style="list-style-type: none"> • Check the fault indication. • Check the sensor voltage. <p>* See Chapter 2 <i>P364</i> for details on the diagnosis method and procedure.</p>
---------------------------------	--

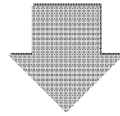

2. Connector/wiring check	<ul style="list-style-type: none"> • Before beginning your work, be sure to turn off the ECU power. • Check the pin of the fuel temperature sensor for deformation and cracks, the condition of the connection, and whether the retainer is loose or removed. • Make sure that the fuel temperature sensor wiring is not cut or the wiring coating is not peeled.
---------------------------	--

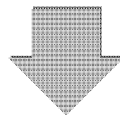

3. Failure diagnosis	<ul style="list-style-type: none"> • Check the resistance value of the fuel temperature sensor. • Check the conduction of the wire-harness. • Check the output voltage of the fuel temperature sensor. <p>* See Chapter 2 <i>P364</i> for details on the diagnosis method and procedure.</p>
----------------------	---

P0182: Fuel temperature sensor error (voltage low)

P code	P0182	Name	Fuel temperature sensor error (voltage low)
SPN/FMI	174/4		

● **DTC detection criteria**

1. Prerequisite, 2. Judgment criteria	Check points
1. No prerequisite. 2. Sensor output is lower than threshold 0.2 V.	Connector Wire-harness Fuel temperature sensor ECU

● **Actions when an error occurs**

Fault mode	[Limited operation]: The fuel temperature is set to 40 °C as the default value. The engine operation is limited.
Limited operation	Yes: • Ash amount reset is prohibited. • When sensor error occurs, rated output of the engine is reduced immediately. • The maximum engine torque is limited to 85%.
Reset criteria	Yes: When the ECU power is turned off, the fault mode is released.
Remarks	

● **Presumed cause of the failure or the error condition**

1. Poor connection of connector
2. Wiring failure of the wire-harness
 - GND short circuit of the sensor signal wire
3. Fuel temperature sensor failure
 - Sensor output failure caused by a GND short circuit of the fuel temperature sensor internal wiring
4. ECU internal circuit failure

● **Diagnosis**

1. Initial diagnosis using SA-D	<ul style="list-style-type: none"> • Check the fault indication. • Check the sensor voltage. <p>* See Chapter 2 <i>P364</i> for details on the diagnosis method and procedure.</p>
---------------------------------	--

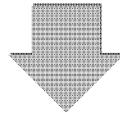

2. Connector/wiring check	<ul style="list-style-type: none"> • Before beginning your work, be sure to turn off the ECU power. • Check the pin of the fuel temperature sensor for deformation and cracks, the condition of the connection, and whether the retainer is loose or removed. • Make sure that the fuel temperature sensor wiring is not cut or the wiring coating is not peeled.
---------------------------	--

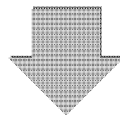

3. Failure diagnosis	<ul style="list-style-type: none"> • Check the resistance value of the fuel temperature sensor. • Check the conduction of the wire-harness. • Check the output voltage of the fuel temperature sensor. <p>* See Chapter 2 <i>P364</i> for details on the diagnosis method and procedure.</p>
----------------------	---

P0168: Fuel temperature high

P code	P0168	Name	Fuel temperature high
SPN/FMI	174/0		

● **DTC detection criteria**

1. Prerequisite, 2. Judgment criteria	Check points
1. No prerequisite. 2. The engine start is complete and the fuel temperature is continuously 90 °C or more for a given length of time.	Fuel temperature sensor system Fuel tank Fuel cooler

● **Actions when an error occurs**

	Settings of the actions during a "fuel temperature high" alarm	
	No	Yes
Fault mode	[Continuous operation]: The engine continues to operate without limitations after the error is detected.	[Limited operation]: The engine operation is limited.
Limited operation	No	Yes: The high idle speed or the engine output maximum injection quantity is limited. (Action differs depending on each customer's settings.)
Reset criteria	Yes: • When the ECU power off is detected, the fault mode is released. • Or automatic recovery is made when the fuel temperature alarm temperature 80 °C or below.	Yes: • When the ECU power off is detected, the fault mode is released. • Or automatic recovery is made when the fuel temperature alarm temperature 80 °C or below continues for a given period of time.
Remarks		

● **Presumed cause of the failure or the error condition**

1. Insufficient fuel in the fuel tank
2. Cooling not possible due to a clogged fuel cooler
3. Fuel temperature sensor system failure

● Diagnosis

1. Initial diagnosis using SA-D	<ul style="list-style-type: none">• Check the fault indication. <p>* See Chapter 2 <i>P364</i> for details on the diagnosis method and procedure.</p>
---------------------------------	---

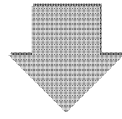

2. Engine check	<ul style="list-style-type: none">• Turn off the ECU power and stop the engine.• Check the engine fuel system.• After a few moments, turn on the ECU power and make sure that the DTC is detected.
-----------------	--

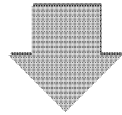

3. Failure diagnosis	<ul style="list-style-type: none">• Check the fuel temperature sensor system. <p>* See Chapter 2 <i>P364</i> for details on the diagnosis method and procedure.</p>
----------------------	---

■ Rail pressure sensor

P0193: Rail pressure sensor error (voltage high)

P code	P0193	Name	Rail pressure sensor error (voltage high)
SPN/FMI	157/3		

● DTC detection criteria

1. Prerequisite, 2. Judgment criteria	Check points
1. No prerequisite. 2. Sensor output is higher than threshold 4.75 V.	Connector Wire-harness Rail pressure sensor ECU

● Actions when an error occurs

Fault mode	[Limited operation]: The rail pressure is set to 160 MPa as the default value. The engine operation is limited.
Limited operation	Yes: <ul style="list-style-type: none"> • When sensor error occurs, rated output of the engine is reduced immediately. • The engine speed is limited to the [maximum torque speed +200 min⁻¹]. • EGR fully closes. • The rail pressure back-up control functions. • DPF regeneration stops. • Rated output of the engine is reduced further after 120 min. • The maximum engine torque is limited to 50%. • The engine speed is limited to the [maximum torque speed +200 min⁻¹].
Reset criteria	Yes: When the ECU power off is detected, the fault mode is released.
Remarks	

● Presumed cause of the failure or the error condition

1. Poor connection of connector
2. Wiring failure of the wire-harness
3. Rail pressure sensor failure
4. ECU internal circuit failure

● **Diagnosis**

1. Initial diagnosis using SA-D	<ul style="list-style-type: none"> • Check the fault indication. • Check the sensor voltage. <p>* See Chapter 2 P368 for details on the diagnosis method and procedure.</p>
---------------------------------	---

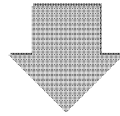

2. Connector/wiring check	<ul style="list-style-type: none"> • Before beginning your work, be sure to turn off the key switch. • Check the pin of the rail pressure sensor for deformation and cracks, the condition of the connection, and whether the retainer is removed. • Make sure that the rail pressure sensor wiring is not cut or the wiring coating is not peeled.
---------------------------	--

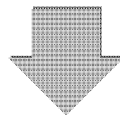

3. Failure diagnosis	<ul style="list-style-type: none"> • Check the conduction of the wire-harness. • Check the ECU output voltage. • Check the rail pressure sensor output voltage. <p>* See Chapter 2 P368 for details on the diagnosis method and procedure.</p>
----------------------	---

P0192: Rail pressure sensor error (voltage low)

P code	P0192	Name	Rail pressure sensor error (voltage low)
SPN/FMI	157/4		

● DTC detection criteria

1. Prerequisite, 2. Judgment criteria	Check points
1. No prerequisite. 2. Sensor output is lower than threshold 0.256 V.	Connector Wire-harness Rail pressure sensor ECU

● Actions when an error occurs

Fault mode	[Limited operation]: The rail pressure is set to 160 MPa as the default value. The engine operation is limited.
Limited operation	Yes: <ul style="list-style-type: none"> • When sensor error occurs, rated output of the engine is reduced immediately. • The engine speed is limited to the [maximum torque speed +200 min⁻¹]. • EGR fully closes. • The rail pressure back-up control functions. • DPF regeneration stops. • Rated output of the engine is reduced further after 120 min. • The maximum engine torque is limited to 50%. • The engine speed is limited to the [maximum torque speed +200 min⁻¹].
Reset criteria	Yes: When the ECU power off is detected, the fault mode is released.
Remarks	

● Presumed cause of the failure or the error condition

1. Poor connection of connector
2. Wiring failure of the wire-harness
3. Rail pressure sensor failure
4. ECU internal circuit failure

● Diagnosis

1. Initial diagnosis using SA-D	<ul style="list-style-type: none">• Check the fault indication.• Check the sensor voltage. <p>* See Chapter 2 P368 for details on the diagnosis method and procedure.</p>
---------------------------------	--

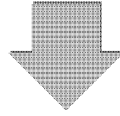

2. Connector/wiring check	<ul style="list-style-type: none">• Before beginning your work, be sure to turn off the ECU power.• Check the pin of the rail pressure sensor for deformation and cracks, the condition of the connection, and whether the retainer is removed.• Make sure that the rail pressure sensor wiring is not cut or the wiring coating is not peeled.
---------------------------	---

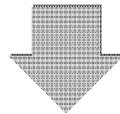

3. Failure diagnosis	<ul style="list-style-type: none">• Check the conduction of the wire-harness.• Check the ECU output voltage.• Check the rail pressure sensor output voltage. <p>* See Chapter 2 P368 for details on the diagnosis method and procedure.</p>
----------------------	---

■ DPF differential pressure sensor

P2455: DPF differential pressure sensor error (voltage high)

P code	P2455	Name	DPF differential pressure sensor error (voltage high)
SPN/FMI	3251/3		

● DTC detection criteria

1. Prerequisite, 2. Judgment criteria	Check points
1. No prerequisite. 2. Sensor output is higher than threshold 4.8 V.	Connector Wire-harness DPF differential pressure sensor ECU

● Actions when an error occurs

Fault mode	[Limited operation]: DPF differential pressure is set to 0 hPa as the default value. The engine operation is limited.
Limited operation	Yes: <ul style="list-style-type: none"> • When sensor error occurs, rated output of the engine is reduced immediately. • The maximum engine torque is limited to 85%. • The engine speed is limited to the [maximum torque speed +200 min⁻¹]. • EGR fully closes. • DPF regeneration stops. • The accumulated PM amount calculation by DPF differential pressure stops. • Ash amount reset is prohibited. • Rated output of the engine is reduced further after 15 min. • The maximum engine torque is limited to 50%. • The engine speed is limited to the [maximum torque speed +200 min⁻¹].
Reset criteria	Yes: Reset criteria: (sensor output is lower than the 4.8 V threshold) the fault mode is automatically released.
Remarks	

● Presumed cause of the failure or the error condition

1. Poor connection of connector
2. Wiring failure of the wire-harness
3. DPF differential pressure sensor failure
4. ECU internal circuit failure

● **Diagnosis**

1. Initial diagnosis using SA-D	<ul style="list-style-type: none"> • Check the fault indication. • Check the sensor voltage. <p>* See Chapter 2 <i>P371</i> for details on the diagnosis method and procedure.</p>
---------------------------------	--

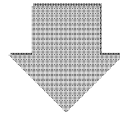

2. Connector/wiring check	<ul style="list-style-type: none"> • Before beginning your work, be sure to turn off the ECU power. • Check the pin of the DPF differential pressure sensor for deformation and cracks, the condition of the connection, and whether the retainer is loose or removed. • Make sure that the DPF differential pressure sensor wiring is not cut or the wiring coating is not peeled.
---------------------------	--

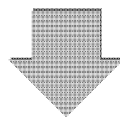

3. Failure diagnosis	<ul style="list-style-type: none"> • Check the resistance value of the DPF differential pressure sensor. • Check the conduction of the wire-harness. • Check the output voltage of the DPF differential pressure sensor. <p>* See Chapter 2 <i>P371</i> for details on the diagnosis method and procedure.</p>
----------------------	---

P2454: DPF differential pressure sensor error (voltage low)

P code	P2454	Name	DPF differential pressure sensor error (voltage low)
SPN/FMI	3251/4		

● **DTC detection criteria**

1. Prerequisite, 2. Judgment criteria	Check points
1. No prerequisite. 2. Sensor output is lower than threshold 0.2 V.	Connector Wire-harness DPF differential pressure sensor ECU

● **Actions when an error occurs**

Fault mode	[Limited operation]: DPF differential pressure is set to 0 hPa as the default value. The engine operation is limited.
Limited operation	Yes: <ul style="list-style-type: none"> • When sensor error occurs, rated output of the engine is reduced immediately. • The maximum engine torque is limited to 85%. • The engine speed is limited to the [maximum torque speed +200 min⁻¹]. • EGR fully closes. • DPF regeneration stops. • The accumulated PM amount calculation by DPF differential pressure stops. • Ash amount reset is prohibited. • Rated output of the engine is reduced further after 15 min. • The maximum engine torque is limited to 50%. • The engine speed is limited to the [maximum torque speed +200 min⁻¹].
Reset criteria	Yes: Reset criteria: (sensor output is lower than the 0.2 V threshold) the fault mode is automatically released.
Remarks	

● **Presumed cause of the failure or the error condition**

1. Poor connection of connector
2. Wiring failure of the wire-harness
3. DPF differential pressure sensor failure
4. ECU internal circuit failure

● **Diagnosis**

1. Initial diagnosis using SA-D	<ul style="list-style-type: none"> • Check the fault indication. • Check the sensor voltage. <p>* See Chapter 2 <i>P371</i> for details on the diagnosis method and procedure.</p>
---------------------------------	--

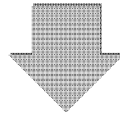

2. Connector/wiring check	<ul style="list-style-type: none"> • Before beginning your work, be sure to turn off the ECU power. • Check the pin of the DPF differential pressure sensor for deformation and cracks, the condition of the connection, and whether the retainer is loose or removed. • Make sure that the DPF differential pressure sensor wiring is not cut or the wiring coating is not peeled.
---------------------------	--

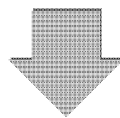

3. Failure diagnosis	<ul style="list-style-type: none"> • Check the resistance value of the DPF differential pressure sensor. • Check the conduction of the wire-harness. • Check the output voltage of the DPF differential pressure sensor. <p>* See Chapter 2 <i>P371</i> for details on the diagnosis method and procedure.</p>
----------------------	---

P2452: DPF differential pressure sensor differential pressure rise error

P code	P2452	Name	DPF differential pressure sensor differential pressure rise error
SPN/FMI	3251/0		

● **DTC detection criteria**

1. Prerequisite, 2. Judgment criteria	Check points
1. The following conditions are all true: <ul style="list-style-type: none"> • DPF differential pressure sensor voltage is normal • After the completion of startup 2. DPF differential pressure is 50 kPa or more for a given period of time (15 s) after the completion of the engine start.	

● **Actions when an error occurs**

Fault mode	[Limited operation]: The engine operation is limited.
Limited operation	Yes: <ul style="list-style-type: none"> • When sensor error occurs, rated output of the engine is reduced immediately. • The maximum engine torque is limited to 85%. • The engine speed is limited to the [maximum torque speed +200 min⁻¹]. • EGR fully closes. • DPF regeneration stops. • Rated output of the engine is reduced further after 15 min. • The maximum engine torque is limited to 50%. • The engine speed is limited to the [maximum torque speed +200 min⁻¹].
Reset criteria	Yes: When the ECU power is turned off, the fault mode is released.
Remarks	

● **Presumed cause of the failure or the error condition**

1. Poor connection of connector
2. Wiring failure of the wire-harness
3. DPF differential pressure sensor failure
4. ECU internal circuit failure

● **Diagnosis**

1. Initial diagnosis using SA-D	<ul style="list-style-type: none"> • Check the fault indication. • Check the sensor voltage. <p>* See Chapter 2 <i>P371</i> for details on the diagnosis method and procedure.</p>
---------------------------------	--

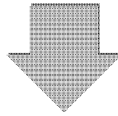

2. Connector/wiring check	<ul style="list-style-type: none"> • Before beginning your work, be sure to turn off the key switch. • Check the pin of the DPF differential pressure sensor for deformation and cracks, the condition of the connection, and whether the retainer is loose or removed. • Make sure that the DPF differential pressure sensor wiring is not cut or the wiring coating is not peeled.
---------------------------	---

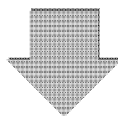

3. Failure diagnosis	<ul style="list-style-type: none"> • Check the conduction of the wire-harness. • Check the output voltage of the DPF differential pressure sensor. <p>* See Chapter 2 <i>P371</i> for details on the diagnosis method and procedure.</p>
----------------------	--

P2453: DPF differential pressure sensor error (abnormal learning value)

P code	P2453	Name	DPF differential pressure sensor error (abnormal learning value)
SPN/FMI	3251/13		

● **DTC detection criteria**

1. Prerequisite, 2. Judgment criteria	Check points
1. • Before engine startup is completed. • DPF differential pressure sensor voltage is normal. * The above conditions are prerequisites for the calculation of the offset value of DPF differential pressure. 2. The final DPF differential pressure offset value is less than the threshold value of XX hPa. Or, the final DPF differential pressure offset value is greater than the threshold value of YY hPa.	

● **Actions when an error occurs**

Fault mode	[Limited operation]: The engine operation is limited.
Limited operation	Yes: • When sensor error occurs, rated output of the engine is reduced immediately. • The maximum engine torque is limited to 85%. • The engine speed is limited to the [maximum torque speed +200 min ⁻¹]. • EGR fully closes. • DPF regeneration stops. • The accumulated PM amount calculation by DPF differential pressure stops. • Ash amount reset is prohibited. • Rated output of the engine is reduced further after 15 min. • The maximum engine torque is limited to 50%. • The engine speed is limited to the [maximum torque speed +200 min ⁻¹].
Reset criteria	Yes: When the ECU power off is detected, the fault mode is released.
Remarks	

● **Presumed cause of the failure or the error condition**

1. Poor connection of connector
2. Wiring failure of the wire-harness
3. EGR pressure sensor failure
4. ECU internal circuit failure

● **Diagnosis**

1. Initial diagnosis using SA-D	<ul style="list-style-type: none"> • Check the fault indication. • Check the sensor voltage. <p>* See Chapter 2 <i>P371</i> for details on the diagnosis method and procedure.</p>
---------------------------------	--

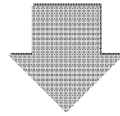

2. Connector/wiring check	<ul style="list-style-type: none"> • Before beginning your work, be sure to turn off the ECU power. • Check the pin of the DPF differential pressure sensor for deformation and cracks, the condition of the connection, and whether the retainer is loose or removed. • Make sure that the DPF differential pressure sensor wiring is not cut or the wiring coating is not peeled.
---------------------------	--

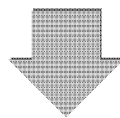

3. Failure diagnosis	<ul style="list-style-type: none"> • Check the conduction of the wire-harness. • Check the output voltage of the DPF differential pressure sensor. <p>* See Chapter 2 <i>P371</i> for details on the diagnosis method and procedure.</p>
----------------------	--

■ DPF substrate/DPF differential pressure sensor

P226D: DPF substrate/DPF differential pressure sensor error

(DPF substrate removal/DPF differential pressure sensor detected value error)

P code	P226D	Name	DPF substrate/DPF differential pressure sensor error (DPF substrate removal/DPF differential pressure sensor detected value error)
SPN/FMI	4795/31		

● DTC detection criteria

1. Prerequisite, 2. Judgment criteria	Check points
1. The following prerequisites should be satisfied: <ul style="list-style-type: none"> • During engine operation • Not during DPF regeneration • No abnormalities in related sensors • Battery voltage is within the prescribed range • Exhaust gas volumetric flow rate (calculated value) is at the prescribed m³/h value 2. After the prerequisites are satisfied for 30 continual seconds, and the current DPF differential pressure is 0.3 kPa.	Connector Wire-harness DPF differential pressure sensor ECU

● Actions when an error occurs

Fault mode	[Continuous operation]: The engine continues to operate without limitations after the error is detected.
Limited operation	No
Reset criteria	Yes: After the prerequisites are satisfied for 30 continual seconds, and detection conditions are not established, reset occurs.
Remarks	

● Presumed cause of the failure or the error condition

1. Poor connection of connector
2. Wiring failure of the wire-harness
 - Short circuit of the sensor signal wire and sensor 5 V
 - Power short circuit of the sensor signal wire
 - Disconnection of the sensor GND wire
 - Disconnection of sensor signal wire
3. ECU internal circuit failure

● **Diagnosis**

1. Initial diagnosis using SA-D	<ul style="list-style-type: none"> • Check the fault indication. • Check the sensor voltage. <p>* See Chapter 2 P371 for details on the diagnosis method and procedure.</p>
---------------------------------	---

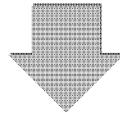

2. Connector/wiring check	<ul style="list-style-type: none"> • Before beginning your work, be sure to turn off the key switch. • Check the pin of the DPF substrate/DPF differential pressure sensor for deformation and cracks, the condition of the connection, and whether the retainer is loose or removed. • Make sure that the DPF substrate/DPF differential pressure sensor wiring is not cut or the wiring coating is not peeled.
---------------------------	---

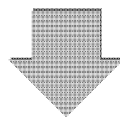

3. Failure diagnosis	<ul style="list-style-type: none"> • Check the DPF substrate/DPF differential pressure sensor resistance value. • Check the conduction of the wire-harness. • Check the DPF substrate/DPF differential pressure sensor output voltage. <p>* See Chapter 2 P371 for details on the diagnosis method and procedure.</p>
----------------------	--

■ DPF high pressure side pressure sensor

P1455: DPF high pressure side pressure sensor error (voltage high)

P code	P1455	Name	DPF high pressure side pressure sensor error (voltage high)
SPN/FMI	3609/3		

● DTC detection criteria

1. Prerequisite, 2. Judgment criteria	Check points
1. No prerequisite. 2. Sensor output is higher than threshold 4.8 V.	Connector Wire-harness DPF high pressure side pressure sensor ECU

● Actions when an error occurs

Fault mode	[Limited operation]: DPF high pressure side pressure is set to 900 hPa as the default value. The engine operation is limited.
Limited operation	Yes: <ul style="list-style-type: none"> • When sensor error occurs, rated output of the engine is reduced immediately. • The maximum engine torque is limited to 85%. • The engine speed is limited to the [maximum torque speed +200 min⁻¹]. • EGR fully closes. • DPF regeneration stops. • The accumulated PM amount calculation by DPF differential pressure stops. • Ash amount reset is prohibited. • Rated output of the engine is reduced further after 15 min. • The maximum engine torque is limited to 50%. • The engine speed is limited to the [maximum torque speed +200 min⁻¹].
Reset criteria	Yes: Reset criteria: (sensor output is lower than the 4.8 V threshold) the fault mode is automatically released.
Remarks	

● Presumed cause of the failure or the error condition

1. Poor connection of connector
2. Wiring failure of the wire-harness
3. DPF high pressure side pressure sensor failure
4. ECU internal circuit failure

● **Diagnosis**

1. Initial diagnosis using SA-D	<ul style="list-style-type: none"> • Check the fault indication. • Check the sensor voltage. <p>* See Chapter 2 P371 for details on the diagnosis method and procedure.</p>
---------------------------------	---

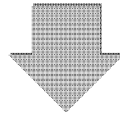

2. Connector/wiring check	<ul style="list-style-type: none"> • Before beginning your work, be sure to turn off the ECU power. • Check the pin of the DPF high pressure side pressure sensor for deformation and cracks, the condition of the connection, and whether the retainer is loose or removed. • Make sure that the DPF high pressure side pressure sensor wiring is not cut or the wiring coating is not peeled.
---------------------------	--

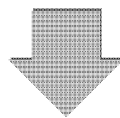

3. Failure diagnosis	<ul style="list-style-type: none"> • Check the resistance value of the DPF high pressure side pressure sensor. • Check the conduction of the wire-harness. • Check the output voltage of the DPF high pressure side pressure sensor. <p>* See Chapter 2 P371 for details on the diagnosis method and procedure.</p>
----------------------	--

P1454: DPF high pressure side pressure sensor error (voltage low)

P code	P1454	Name	DPF high pressure side pressure sensor error (voltage low)
SPN/FMI	3609/4		

● DTC detection criteria

1. Prerequisite, 2. Judgment criteria	Check points
1. No prerequisite. 2. Sensor output is lower than threshold 0.2 V.	Connector Wire-harness DPF high pressure side pressure sensor ECU

● Actions when an error occurs

Fault mode	[Limited operation]: DPF high pressure side pressure is set to 900 hPa as the default value. The engine operation is limited.
Limited operation	Yes: <ul style="list-style-type: none"> • When sensor error occurs, rated output of the engine is reduced immediately. • The maximum engine torque is limited to 85%. • The engine speed is limited to the [maximum torque speed +200 min⁻¹]. • EGR fully closes. • DPF regeneration stops. • The accumulated PM amount calculation by DPF differential pressure stops. • Ash amount reset is prohibited. • Rated output of the engine is reduced further after 15 min. • The maximum engine torque is limited to 50%. • The engine speed is limited to the [maximum torque speed +200 min⁻¹].
Reset criteria	Yes: Reset criteria: (sensor output is lower than the 0.2 V threshold) the fault mode is automatically released.
Remarks	

● Presumed cause of the failure or the error condition

1. Poor connection of connector
2. Wiring failure of the wire-harness
3. DPF high pressure side pressure sensor failure
4. ECU internal circuit failure

● **Diagnosis**

1. Initial diagnosis using SA-D	<ul style="list-style-type: none"> • Check the fault indication. • Check the sensor voltage. <p>* See Chapter 2 <i>P371</i> for details on the diagnosis method and procedure.</p>
---------------------------------	--

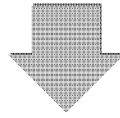

2. Connector/wiring check	<ul style="list-style-type: none"> • Before beginning your work, be sure to turn off the ECU power. • Check the pin of the DPF high pressure side pressure sensor for deformation and cracks, the condition of the connection, and whether the retainer is loose or removed. • Make sure that the DPF high pressure side pressure sensor wiring is not cut or the wiring coating is not peeled.
---------------------------	--

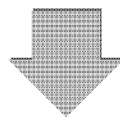

3. Failure diagnosis	<ul style="list-style-type: none"> • Check the resistance value of the DPF high pressure side pressure sensor. • Check the conduction of the wire-harness. • Check the output voltage of the DPF high pressure side pressure sensor. <p>* See Chapter 2 <i>P371</i> for details on the diagnosis method and procedure.</p>
----------------------	---

P167C: DPF high pressure side pressure sensor error (detected value error)

P code	P167C	Name	DPF high pressure side pressure sensor error (detected value error)
SPN/FMI	3609/10		

● **DTC detection criteria**

1. Prerequisite, 2. Judgment criteria	Check points
<p>1. The following prerequisites should be satisfied:</p> <ul style="list-style-type: none"> • No abnormalities in related sensors • Battery voltage is within the prescribed range • During engine operation • Not during DPF regeneration • Current injection amount is equal to or more than the predetermined value determine by the engine rpm • Not during forced operation by service tool • Atmospheric pressure is 82.3 kPa or more <p>2. After the prerequisite conditions have been established for 10 continual seconds, the difference between the pressure on the DPF high pressure side (after learning) and the atmospheric pressure shall be 0.3 kPa or less.</p>	<p>Connector Wire-harness DPF high pressure side pressure sensor ECU</p>

● **Actions when an error occurs**

Fault mode	[Continuous operation]: The engine continues to operate without limitations after the error is detected.
Limited operation	No
Reset criteria	Yes: The prerequisites are satisfied for 10 continual seconds, and detection conditions are not established, reset occurs.
Remarks	

● **Presumed cause of the failure or the error condition**

1. Poor connection of connector
2. Wiring failure of the wire-harness
3. DPF high pressure side pressure sensor failure
4. ECU internal circuit failure

● **Diagnosis**

1. Initial diagnosis using SA-D	<ul style="list-style-type: none"> • Check the fault indication. • Check the sensor voltage. <p>* See Chapter 2 <i>P371</i> for details on the diagnosis method and procedure.</p>
---------------------------------	--

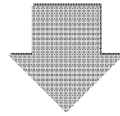

2. Connector/wiring check	<ul style="list-style-type: none"> • Before beginning your work, be sure to turn off the ECU power. • Check the pin of the DPF high pressure side pressure sensor for deformation and cracks, the condition of the connection, and whether the retainer is loose or removed. • Make sure that the DPF high pressure side pressure sensor wiring is not cut or the wiring coating is not peeled.
---------------------------	--

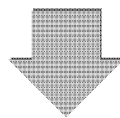

3. Failure diagnosis	<ul style="list-style-type: none"> • Check the resistance value of the DPF high pressure side pressure sensor. • Check the conduction of the wire-harness. • Check the output voltage of the DPF high pressure side pressure sensor. <p>* See Chapter 2 <i>P371</i> for details on the diagnosis method and procedure.</p>
----------------------	---

■ DPF inlet temperature sensor

P1428: DPF inlet temperature sensor error (voltage high)

P code	P1428	Name	DPF inlet temperature sensor error (voltage high)
SPN/FMI	3242/3		

● DTC detection criteria

1. Prerequisite, 2. Judgment criteria	Check points
1. No prerequisite. 2. Sensor output is higher than threshold 4.8 V.	Connector Wire-harness DPF inlet temperature sensor ECU

● Actions when an error occurs

Fault mode	[Limited operation]: Set the DPF inlet temperature to 350 °C as default value. The engine operation is limited.
Limited operation	Yes: • When sensor error occurs, rated output of the engine is reduced immediately. <ul style="list-style-type: none"> • The maximum engine torque is limited to 85%. • The engine speed is limited to the [maximum torque speed +200 min⁻¹]. • EGR fully closes. • DPF regeneration stops. • Ash amount reset is prohibited. • Rated output of the engine is reduced further after 15 min. • The maximum engine torque is limited to 50%. • The engine speed is limited to the [maximum torque speed +200 min⁻¹].
Reset criteria	Yes: Reset criteria: (sensor output is lower than the 4.8 V threshold) the fault mode is automatically released.
Remarks	

● Presumed cause of the failure or the error condition

1. Poor connection of connector
2. Wiring failure of the wire-harness
 - Disconnection or power short circuit of the sensor GND wire
 - Disconnection or power short circuit of the sensor signal wire
3. DPF inlet temperature sensor failure
 - Sensor output failure caused by a disconnection of the DPF inlet temperature sensor internal wiring
4. ECU internal circuit failure

● Diagnosis

1. Initial diagnosis using SA-D	<ul style="list-style-type: none">• Check the fault indication.• Check the sensor voltage. <p>* See Chapter 2 P374 for details on the diagnosis method and procedure.</p>
---------------------------------	--

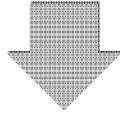

2. Connector/wiring check	<ul style="list-style-type: none">• Before beginning your work, be sure to turn off the ECU power.• Check the pin of the DPF inlet temperature sensor for deformation and cracks, the condition of the connection, and whether the retainer is loose or removed.• Make sure that the DPF inlet temperature sensor wiring is not cut or the wiring coating is not peeled.
---------------------------	--

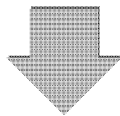

3. Failure diagnosis	<ul style="list-style-type: none">• Check the resistance value of the DPF inlet temperature sensor.• Check the conduction of the wire-harness.• Check the output voltage of the DPF inlet temperature sensor. <p>* See Chapter 2 P374 for details on the diagnosis method and procedure.</p>
----------------------	--

P1427: DPF inlet temperature sensor error (voltage low)

P code	P1427	Name	DPF inlet temperature sensor error (voltage low)
SPN/FMI	3242/4		

● **DTC detection criteria**

1. Prerequisite, 2. Judgment criteria	Check points
1. No prerequisite. 2. Sensor output is lower than threshold 0.2 V.	Connector Wire-harness DPF inlet temperature sensor ECU

● **Actions when an error occurs**

Fault mode	[Limited operation]: Set the DPF inlet temperature to 350 °C as default value. The engine operation is limited.
Limited operation	Yes: <ul style="list-style-type: none"> • When sensor error occurs, rated output of the engine is reduced immediately. • The maximum engine torque is limited to 85%. • The engine speed is limited to the [maximum torque speed +200 min⁻¹]. • EGR fully closes. • DPF regeneration stops. • Ash amount reset is prohibited. • Rated output of the engine is reduced further after 15 min. • The maximum engine torque is limited to 50%. • The engine speed is limited to the [maximum torque speed +200 min⁻¹].
Reset criteria	Yes: Reset criteria: (sensor output is lower than the 0.2 V threshold) the fault mode is automatically released.
Remarks	

● **Presumed cause of the failure or the error condition**

1. Poor connection of connector
2. Wiring failure of the wire-harness
 - GND short circuit of the sensor signal wire
3. DPF inlet temperature sensor failure
 - Sensor output failure caused by a GND short circuit of the DPF inlet temperature sensor internal wiring
4. ECU internal circuit failure

● **Diagnosis**

1. Initial diagnosis using SA-D	<ul style="list-style-type: none"> • Check the fault indication. • Check the sensor voltage. <p>* See Chapter 2 P374 for details on the diagnosis method and procedure.</p>
---------------------------------	---

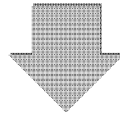

2. Connector/wiring check	<ul style="list-style-type: none"> • Before beginning your work, turn off the ECU power. • Check the pin of the DPF inlet temperature sensor for deformation and cracks, the condition of the connection, and whether the retainer is loose or removed. • Make sure that the DPF inlet temperature sensor wiring is not cut or the wiring coating is not peeled.
---------------------------	---

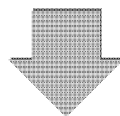

3. Failure diagnosis	<ul style="list-style-type: none"> • Check the resistance value of the DPF inlet temperature sensor. • Check the conduction of the wire-harness. • Check the output voltage of the DPF inlet temperature sensor. <p>* See Chapter 2 P374 for details on the diagnosis method and procedure.</p>
----------------------	--

P167E: DPF inlet temperature sensor error (detected value error)

P code	P167E	Name	DPF inlet temperature sensor error (detected value error)
SPN/FMI	3242/10		

● **DTC detection criteria**

1. Prerequisite, 2. Judgment criteria	Check points
<p>1. The following prerequisites should be satisfied:</p> <ul style="list-style-type: none"> • No abnormalities in related sensors • Battery voltage is within the prescribed range • Not during forced operation by service tool • The last driving cycle has completely warmed up • The cooling water temperature is 40 °C or less immediately after turning the key ON • The DPF intermediate temperature is 47.3 °C or less immediately after turning the key ON • The difference between the coolant temperature and the intake air temperature immediately after turning the key ON is within 2.5 °C • The difference between the DPF intermediate temperature and the intake air temperature immediately after turning the key ON is within ±12.8 °C • The current DPF intermediate temperature is equal to or more than, for 1 second, the DPF intermediate temperature immediately after the key is turned ON. • Not during DPF regeneration • Atmospheric pressure is 82.3 kPa or more * Completely warmed up: water temperature is 60 °C or more, and 600 seconds have elapsed since start up. <p>2. After the prerequisite conditions have been established for 10 continual seconds, the following shall be satisfied:</p> <ul style="list-style-type: none"> • (current DPF inlet temperature) - (DPF inlet temperature immediately after key is turned ON) ≤ 100 °C 	<p>Connector Wire-harness DPF inlet temperature sensor ECU</p>

● **Actions when an error occurs**

Fault mode	[Continuous operation]: The engine continues to operate without limitations after the error is detected.
Limited operation	No
Reset criteria	Yes: After the prerequisites are satisfied, and detection conditions are not established, reset occurs.
Remarks	

● **Presumed cause of the failure or the error condition**

1. Poor connection of connector
2. Wiring failure of the wire-harness
 - GND short circuit of the sensor signal wire
3. DPF inlet temperature sensor failure
 - Sensor output failure caused by a GND Short circuit of the DPF inlet temperature sensor internal wiring
4. ECU internal circuit failure

● Diagnosis

1. Initial diagnosis using SA-D	<ul style="list-style-type: none">• Check the fault indication.• Check the sensor voltage. <p>* See Chapter 2 P374 for details on the diagnosis method and procedure.</p>
---------------------------------	--

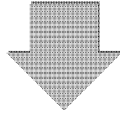

2. Connector/wiring check	<ul style="list-style-type: none">• Before beginning your work, be sure to turn off the key switch.• Check the pin of the DPF inlet temperature sensor for deformation and cracks, the condition of the connection, and whether the retainer is loose or removed.• Make sure that the DPF inlet temperature sensor wiring is not cut or the wiring coating is not peeled.
---------------------------	---

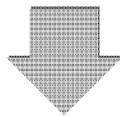

3. Failure diagnosis	<ul style="list-style-type: none">• Check the resistance value of the DPF inlet temperature sensor.• Check the conduction of the wire-harness.• Check the output voltage of the DPF inlet temperature sensor. <p>* See Chapter 2 P374 for details on the diagnosis method and procedure.</p>
----------------------	--

P1436: DPF inlet temperature sensor error (high temperature)

P code	P1436	Name	DPF inlet temperature sensor error (high temperature)
SPN/FMI	3242/0		

● **DTC detection criteria**

1. Prerequisite, 2. Judgment criteria	Check points
1. DPF inlet temperature sensor normal. 2. The DPF inlet temperature is 700 °C or more for a given period of time (15 s).	Connector Wire-harness DPF inlet temperature sensor ECU Injector Exhaust piping

● **Actions when an error occurs**

Fault mode	[Limited operation]: The engine operation is limited.
Limited operation	Yes: • When sensor error occurs, rated output of the engine is reduced immediately. • The maximum engine torque is limited to 85%. • Rated output of the engine is reduced further after 120 min. • The maximum engine torque is limited to 50%.
Reset criteria	Yes: When the ECU power is turned off, the fault mode is released.
Remarks	

● **Presumed cause of the failure or the error condition**

1. Poor connection of connector
2. Wiring failure of the wire-harness
3. DPF inlet temperature sensor system failure
4. ECU internal circuit failure
5. Blow-by of combustion gas
 - Piping damage in the passage to DOC
6. Injector failure
 - Decrease in injection quantity
 - Injection timing error

■ DPF intermediate temperature sensor

P1434: DPF intermediate temperature sensor error (voltage high)

P code	P1434	Name	DPF intermediate temperature sensor error (voltage high)
SPN/FMI	3250/3		

● DTC detection criteria

1. Prerequisite, 2. Judgment criteria	Check points
1. No prerequisite. 2. Sensor output is higher than threshold 4.8 V.	Connector Wire-harness DPF intermediate temperature sensor ECU

● Actions when an error occurs

Fault mode	[Limited operation]: Set the DPF intermediate temperature to 350 °C as default value. The engine operation is limited.
Limited operation	Yes: <ul style="list-style-type: none"> • When sensor error occurs, rated output of the engine is reduced immediately. • The maximum engine torque is limited to 85%. • The engine speed is limited to the [maximum torque speed +200 min⁻¹]. • EGR fully closes. • DPF regeneration stops. • The accumulated PM amount calculation by DPF differential pressure stops. • Ash amount reset is prohibited. • Rated output of the engine is reduced further after 15 min. • The maximum engine torque is limited to 50%. • The engine speed is limited to the [maximum torque speed +200 min⁻¹].
Reset criteria	Yes: Reset criteria: (sensor output is lower than the 4.8 V threshold) the fault mode is automatically released.
Remarks	

● Presumed cause of the failure or the error condition

1. Poor connection of connector
2. Wiring failure of the wire-harness
 - Disconnection or power short circuit of the sensor GND wire
 - Disconnection or power short circuit of the sensor signal wire
3. DPF intermediate temperature sensor failure
 - Sensor output failure caused by an disconnection of the DPF intermediate temperature sensor internal wiring
4. ECU internal circuit failure

● Diagnosis

1. Initial diagnosis using SA-D	<ul style="list-style-type: none">• Check the fault indication.• Check the sensor voltage. <p>* See Chapter 2 P378 for details on the diagnosis method and procedure.</p>
---------------------------------	--

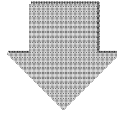

2. Connector/wiring check	<ul style="list-style-type: none">• Before beginning your work, be sure to turn off the ECU power.• Check the pin of the DPF intermediate temperature sensor for deformation and cracks, the condition of the connection, and whether the retainer is loose or removed.• Make sure that the DPF intermediate temperature sensor wiring is not cut or the wiring coating is not peeled.
---------------------------	--

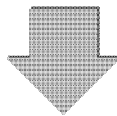

3. Failure diagnosis	<ul style="list-style-type: none">• Check the resistance value of the DPF intermediate temperature sensor.• Check the conduction of the wire-harness.• Check the output voltage of the DPF intermediate temperature sensor. <p>* See Chapter 2 P378 for details on the diagnosis method and procedure.</p>
----------------------	--

P1435: DPF intermediate temperature sensor error (voltage low)

P code	P1435	Name	DPF intermediate temperature sensor error (voltage low)
SPN/FMI	3250/4		

● DTC detection criteria

1. Prerequisite, 2. Judgment criteria	Check points
1. No prerequisite. 2. Sensor output is lower than threshold 0.2 V.	Connector Wire-harness DPF intermediate temperature sensor ECU

● Actions when an error occurs

Fault mode	[Limited operation]: Set the DPF intermediate temperature to 350 °C as default value. The engine operation is limited.
Limited operation	Yes: <ul style="list-style-type: none"> • When sensor error occurs, rated output of the engine is reduced immediately. • The maximum engine torque is limited to 85%. • The engine speed is limited to the [maximum torque speed +200 min⁻¹]. • EGR fully closes. • DPF regeneration stops. • The accumulated PM amount calculation by DPF differential pressure stops. • Ash amount reset is prohibited. • Rated output of the engine is reduced further after 15 min. • The maximum engine torque is limited to 50%. • The engine speed is limited to the [maximum torque speed +200 min⁻¹].
Reset criteria	Yes: Reset criteria: (sensor output is lower than the 0.2 V threshold) the fault mode is automatically released.
Remarks	

● Presumed cause of the failure or the error condition

1. Poor connection of connector
2. Wiring failure of the wire-harness
 - GND short circuit of the sensor signal wire
3. DPF intermediate temperature sensor failure
 - Sensor output failure caused by a GND short circuit of the DPF intermediate temperature sensor internal wiring
4. ECU internal circuit failure

● Diagnosis

1. Initial diagnosis using SA-D	<ul style="list-style-type: none">• Check the fault indication.• Check the sensor voltage. <p>* See Chapter 2 P378 for details on the diagnosis method and procedure.</p>
---------------------------------	--

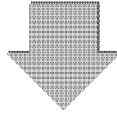

2. Connector/wiring check	<ul style="list-style-type: none">• Before beginning your work, be sure to turn off the ECU power.• Check the pin of the DPF intermediate temperature sensor for deformation and cracks, the condition of the connection, and whether the retainer is loose or removed.• Make sure that the DPF intermediate temperature sensor wiring is not cut or the wiring coating is not peeled.
---------------------------	--

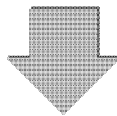

3. Failure diagnosis	<ul style="list-style-type: none">• Check the resistance value of the DPF intermediate temperature sensor.• Check the conduction of the wire-harness.• Check the output voltage of the DPF intermediate temperature sensor. <p>* See Chapter 2 P378 for details on the diagnosis method and procedure.</p>
----------------------	--

P167A: DPF intermediate temperature sensor error (detected value error)

P code	P167A	Name	DPF intermediate temperature sensor error (detected value error)
SPN/FMI	3250/10		

● DTC detection criteria

1. Prerequisite, 2. Judgment criteria	Check points
<p>1. The following prerequisites should be satisfied:</p> <ul style="list-style-type: none"> • No abnormalities in related sensors • Battery voltage is within the prescribed range • Not during forced operation by service tool • The last driving cycle has completely warmed up • The cooling water temperature is 40 °C or less immediately after turning the key ON • The DPF inlet temperature is 41.2 °C or less immediately after turning the key ON • The difference between the coolant temperature and the intake air temperature immediately after turning the key ON is within 2.5 °C • The difference between the DPF inlet temperature and the intake air temperature immediately after turning the key ON is within ± 6.6 °C • The current DPF inlet temperature is equal to or more than, for 60 seconds, the DPF inlet temperature immediately after the key is turned ON. • Not during DPF regeneration • Atmospheric pressure is 82.3 kPa or more * Completely warmed up: water temperature is 60 °C or more, and 600 seconds have elapsed since start up. <p>2. After the prerequisite conditions have been established for 10 continual seconds, the following shall be satisfied:</p> <ul style="list-style-type: none"> • (current DPF intermediate temperature) - (DPF intermediate temperature immediately after key is turned ON) ≤ 100 °C 	Connector Wire-harness DPF intermediate temperature sensor ECU

● Actions when an error occurs

Fault mode	[Continuous operation]. The engine continues to operate without limitations after the error is detected.
Limited operation	No
Reset criteria	Yes: After the prerequisites are satisfied, and detection conditions are not established, reset occurs.
Remarks	

● Presumed cause of the failure or the error condition

1. Poor connection of connector
2. Wiring failure of the wire-harness
 - GND short circuit of the sensor signal wire
3. DPF intermediate temperature sensor failure
 - Sensor output failure caused by a GND Short circuit of the DPF intermediate temperature sensor internal wiring
4. ECU internal circuit failure

● Diagnosis

1. Initial diagnosis using SA-D	<ul style="list-style-type: none">• Check the fault indication.• Check the sensor voltage. <p>* See Chapter 2 P378 for details on the diagnosis method and procedure.</p>
---------------------------------	--

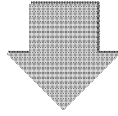

2. Connector/wiring check	<ul style="list-style-type: none">• Before beginning your work, be sure to turn off the ECU power.• Check the pin of the DPF intermediate temperature sensor for deformation and cracks, the condition of the connection, and whether the retainer is loose or removed.• Make sure that the DPF intermediate temperature sensor wiring is not cut or the wiring coating is not peeled.
---------------------------	--

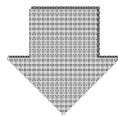

3. Failure diagnosis	<ul style="list-style-type: none">• Check the resistance value of the DPF intermediate temperature sensor.• Check the conduction of the wire-harness.• Check the output voltage of the DPF intermediate temperature sensor. <p>* See Chapter 2 P378 for details on the diagnosis method and procedure.</p>
----------------------	--

P0420: DPF intermediate temperature sensor temperature too low

P code	P0420	Name	DPF intermediate temperature sensor temperature too low
SPN/FMI	3250/1		

● **DTC detection criteria**

1. Prerequisite, 2. Judgment criteria	Check points
1. No prerequisite. 2. Any of the following conditions is kept for a given length of time (1200 seconds): <ul style="list-style-type: none"> • DPF intermediate temperature becomes 300 °C or lower during the stationary regeneration • DPF intermediate temperature becomes 250 °C or lower during the recovery regeneration 	Connector Wire-harness DPF intermediate temperature sensor system ECU Injector DOC Piping

● **Actions when an error occurs**

Fault mode	[Limited operation]: The engine operation is limited.
Limited operation	Yes: • When sensor error occurs, rated output of the engine is reduced immediately. <ul style="list-style-type: none"> • The maximum engine torque is limited to 85%. • EGR fully closes. • DPF regeneration stops. • Rated output of the engine is reduced further after 120 min. • The maximum engine torque is limited to 50%.
Reset criteria	Yes: When the ECU power is turned off, the fault mode is released.
Remarks	

● **Presumed cause of the failure or the error condition**

1. Poor connection of connector
2. Wiring failure of the wire-harness
3. DPF intermediate temperature sensor system failure
4. ECU internal circuit failure
5. DOC deterioration due to the external factor such as sulfur poisoning
 - Increase in activated temperature
6. Blow-by of combustion gas
 - Catalytic damage
 - Piping damage in the passage to DOC
7. Injector failure
 - Decrease in injection quantity
 - Injection timing error

■ Atmospheric pressure sensor

P2229: Atmospheric pressure sensor error (voltage high)

P code	P2229	Name	Atmospheric pressure sensor error (voltage high)
SPN/FMI	108/3		

● DTC detection criteria

1. Prerequisite, 2. Judgment criteria	Check points
1. No prerequisite. 2. Sensor output is higher than threshold 4.8 V.	Atmospheric pressure sensor ECU

● Actions when an error occurs

Fault mode	[Limited operation]: Atmospheric pressure is set to 900 hPa as the default value. The engine operation is limited.
Limited operation	Yes: <ul style="list-style-type: none"> • When sensor error occurs, rated output of the engine is reduced immediately. • The maximum engine torque is limited to 85%. • EGR fully closes. • Ash amount reset is prohibited. • Rated output of the engine is reduced further after 120 min. • The maximum engine torque is limited to 50%. • Simultaneous to the above operating restrictions, engine operation restrictions are applied according to the inducement level of the EGR system abnormality. The level of restriction applied will whichever level is higher. <ul style="list-style-type: none"> a. Warning When engine operation time is less than 36 hours since abnormality occurred. In this case, restrictions on engine speed/fuel injection quantity vary depending on the error. b. Inducement (Low level) When engine operation time 36 hours or more and less than 100 hours from error occurrences (or less than 5 hours (*1)), Inducement level becomes Low level. In this case, the torque is limited to 75%. (For some errors, the engine speed is restricted to low idle and the maximum fuel injection quantity is restricted to 50%.) c. Inducement (Severe level) When engine operation time is 100 hours or more from error occurrences (or 5 hours or more (*1)), Inducement level becomes Severe level. In this case, the engine speed is restricted to 60% of its rated speed (in some engine models), and the torque is restricted to 50%. (For some errors, the engine speed is restricted to low idle and the maximum fuel injection quantity is restricted to 50%.) <p>(*1) This time indicates a case when another abnormality that results in inducement occurs within 40 hours of recovery from a previous abnormality.</p>
Reset criteria	Yes: When the ECU power is turned off, the fault mode is released.
Remarks	

● Presumed cause of the failure or the error condition

1. ECU internal atmospheric pressure sensor failure
2. ECU internal circuit failure

● Diagnosis

1. Initial diagnosis using SA-D	<ul style="list-style-type: none"> • Check the fault indication. • Switch the ECU power from ON to OFF to check the fault indication again. <p>* See Chapter 2 P470 for details on the diagnosis method and procedure.</p>
---------------------------------	--

P2228: Atmospheric pressure sensor error (voltage low)

P code	P2228	Name	Atmospheric pressure sensor error (voltage low)
SPN/FMI	108/4		

● **DTC detection criteria**

1. Prerequisite, 2. Judgment criteria	Check points
1. No prerequisite. 2. Sensor output is lower than threshold 0.2 V.	Atmospheric pressure sensor ECU

● **Actions when an error occurs**

Fault mode	[Limited operation]: Atmospheric pressure is set to 900 hPa as the default value. The engine operation is limited.
Limited operation	<p>Yes:</p> <ul style="list-style-type: none"> • When sensor error occurs, rated output of the engine is reduced immediately. • The maximum engine torque is limited to 85%. • EGR fully closes. • Ash amount reset is prohibited. • Rated output of the engine is reduced further after 120 min. • The maximum engine torque is limited to 50%. • Simultaneous to the above operating restrictions, engine operation restrictions are applied according to the inducement level of the EGR system abnormality. The level of restriction applied will whichever level is higher. <ul style="list-style-type: none"> a. Warning When engine operation time is less than 36 hours since abnormality occurred. In this case, restrictions on engine speed/fuel injection quantity vary depending on the error. b. Inducement (Low level) When engine operation time 36 hours or more and less than 100 hours from error occurrences (or less than 5 hours (*1)), Inducement level becomes Low level. In this case, the torque is limited to 75%. (For some errors, the engine speed is restricted to low idle and the maximum fuel injection quantity is restricted to 50%.) c. Inducement (Severe level) When engine operation time is 100 hours or more from error occurrences (or 5 hours or more (*1)), Inducement level becomes Severe level. In this case, the engine speed is restricted to 60% of its rated speed (in some engine models), and the torque is restricted to 50%. (For some errors, the engine speed is restricted to low idle and the maximum fuel injection quantity is restricted to 50%.) <p>(*1) This time indicates a case when another abnormality that results in inducement occurs within 40 hours of recovery from a previous abnormality.</p>
Reset criteria	Yes: When the ECU power is turned off, the fault mode is released.
Remarks	

● **Presumed cause of the failure or the error condition**

1. ECU internal atmospheric pressure sensor failure
2. ECU internal circuit failure

● **Diagnosis**

1. Initial diagnosis using SA-D	<ul style="list-style-type: none"> • Check the fault indication. • Switch the ECU power from ON to OFF to check the fault indication again. <p>* See Chapter 2 P470 for details on the diagnosis method and procedure.</p>
---------------------------------	--

P2226: Atmospheric pressure sensor error (Digital IC error)

P code	P2226	Name	Atmospheric pressure sensor error (Digital IC error)
SPN/FMI	108/12		

● **DTC detection criteria**

1. Prerequisite, 2. Judgment criteria	Check points
1. No prerequisite. 2. Receives error signal from atmospheric pressure sensor IC.	Atmospheric pressure sensor ECU

● **Actions when an error occurs**

Fault mode	[Limited operation]: Atmospheric pressure is set to 900 hPa as the default value. The engine operation is limited.
Limited operation	Yes: <ul style="list-style-type: none"> • When sensor error occurs, rated output of the engine is reduced immediately. • The maximum engine torque is limited to 85%. • EGR fully closes. • Ash amount reset is prohibited. • Rated output of the engine is reduced further after 120 min. • The maximum engine torque is limited to 50%. • Simultaneous to the above operating restrictions, engine operation restrictions are applied according to the inducement level of the EGR system abnormality. The level of restriction applied will whichever level is higher. <ul style="list-style-type: none"> a. Warning When engine operation time is less than 36 hours since abnormality occurred. In this case, restrictions on engine speed/fuel injection quantity vary depending on the error. b. Inducement (Low level) When engine operation time 36 hours or more and less than 100 hours from error occurrences (or less than 5 hours (*1)), Inducement level becomes Low level. In this case, the torque is limited to 75%. (For some errors, the engine speed is restricted to low idle and the maximum fuel injection quantity is restricted to 50%.) c. Inducement (Severe level) When engine operation time is 100 hours or more from error occurrences (or 5 hours or more (*1)), Inducement level becomes Severe level. In this case, the engine speed is restricted to 60% of its rated speed (in some engine models), and the torque is restricted to 50%. (For some errors, the engine speed is restricted to low idle and the maximum fuel injection quantity is restricted to 50%.) <p>(*1) This time indicates a case when another abnormality that results in inducement occurs within 40 hours of recovery from a previous abnormality.</p>
Reset criteria	Yes: When the ECU power is turned off, the fault mode is released.
Remarks	

● **Presumed cause of the failure or the error condition**

1. ECU internal atmospheric pressure sensor failure
2. ECU internal circuit failure

● **Diagnosis**

1. Initial diagnosis using SA-D	<ul style="list-style-type: none"> • Check the fault indication. • Switch the ECU power from ON to OFF to check the fault indication again. <p>* See Chapter 2 P470 for details on the diagnosis method and procedure.</p>
---------------------------------	--

P1231: Atmospheric pressure sensor error (characteristic error)

P code	P1231	Name	Atmospheric pressure sensor error (characteristic error)
SPN/FMI	108/10		

● DTC detection criteria

1. Prerequisite, 2. Judgment criteria	Check points
1. 2. The intake manifold pressure final offset quantity 5 kPa or more and the exhaust manifold pressure final offset quantity 5 kPa or more continue for 600 ms.	Atmospheric pressure sensor ECU

● Actions when an error occurs

Fault mode	[Limited operation]: The engine operation is limited.
Limited operation	<p>Yes:</p> <ul style="list-style-type: none"> • When sensor error occurs, rated output of the engine is reduced immediately. • The maximum engine torque is limited to 85%. • EGR fully closes. • Rated output of the engine is reduced further after 120 min. • The maximum engine torque is limited to 50%. • Simultaneous to the above operating restrictions, engine operation restrictions are applied according to the inducement level of the EGR system abnormality. The level of restriction applied will whichever level is higher. <ul style="list-style-type: none"> a. Warning <p>When engine operation time is less than 36 hours since abnormality occurred. In this case, restrictions on engine speed/fuel injection quantity vary depending on the error.</p> b. Inducement (Low level) <p>When engine operation time 36 hours or more and less than 100 hours from error occurrences (or less than 5 hours (*1)), Inducement level becomes Low level. In this case, the torque is limited to 75%. (For some errors, the engine speed is restricted to low idle and the maximum fuel injection quantity is restricted to 50%.)</p> c. Inducement (Severe level) <p>When engine operation time is 100 hours or more from error occurrences (or 5 hours or more (*1)), Inducement level becomes Severe level. In this case, the engine speed is restricted to 60% of its rated speed (in some engine models), and the torque is restricted to 50%. (For some errors, the engine speed is restricted to low idle and the maximum fuel injection quantity is restricted to 50%.)</p> <p>(*1) This time indicates a case when another abnormality that results in inducement occurs within 40 hours of recovery from a previous abnormality.</p>
Reset criteria	Yes: When the ECU power is turned off, the fault mode is released.
Remarks	

● Presumed cause of the failure or the error condition

1. ECU internal atmospheric pressure sensor failure
2. ECU internal circuit failure
3. * Simultaneous characteristic malfunction of EGR high pressure side pressure sensor and low pressure side sensor
4. Blockage or icing caused by foreign matters in the sensor parts

* This error can be detected by the simultaneous characteristic malfunction of EGR high pressure side pressure sensor and low pressure side sensor. However, the possibility of the occurrence of the characteristic malfunction at the same time is low. So, if the error is not released after replacing the ECU, perform failure diagnosis on EGR high pressure side pressure sensor and EGR low pressure side pressure sensor, respectively.

● Diagnosis

1. Initial diagnosis using SA-D	<ul style="list-style-type: none">• Check the fault indication.• Switch the ECU power from ON to OFF to check the fault indication again. <p>* See Chapter 2 P470 for details on the diagnosis method and procedure.</p>
---------------------------------	---

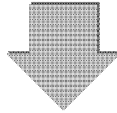

2. Diagnosis for EGR high pressure side pressure sensor and low pressure side pressure sensor	<ul style="list-style-type: none">• Check the sensor resistance value.• Check the conduction of the wire-harness.• Check the sensor output voltage. <p>* See Chapter 2 P470 for details on the diagnosis method and procedure.</p>
---	--

■ EGR gas temperature sensor

P041D: EGR gas temperature sensor error (voltage high)

P code	P041D	Name	EGR gas temperature sensor error (voltage high)
SPN/FMI	412/3		

● DTC detection criteria

1. Prerequisite, 2. Judgment criteria	Check points
1. No prerequisite. 2. Sensor output is higher than threshold 4.8 V.	Connector Wire-harness EGR gas temperature sensor ECU

● Actions when an error occurs

Fault mode	[Limited operation]: Set the EGR gas temperature to 30 °C as default value. The engine operation is limited.
Limited operation	Yes: <ul style="list-style-type: none"> • When sensor error occurs, rated output of the engine is reduced immediately. <ul style="list-style-type: none"> • The maximum engine torque is limited to 85%. • EGR fully closes. • Ash amount reset is prohibited. • Rated output of the engine is reduced further after 120 min. • The maximum engine torque is limited to 50%. • Simultaneous to the above operating restrictions, engine operation restrictions are applied according to the inducement level of the EGR system abnormality. The level of restriction applied will whichever level is higher. <ul style="list-style-type: none"> a. Warning <ul style="list-style-type: none"> When engine operation time is less than 36 hours since abnormality occurred. In this case, restrictions on engine speed/fuel injection quantity vary depending on the error. b. Inducement (Low level) <ul style="list-style-type: none"> When engine operation time 36 hours or more and less than 100 hours from error occurrences (or less than 5 hours (*1)), Inducement level becomes Low level. In this case, the torque is limited to 75%. (For some errors, the engine speed is restricted to low idle and the maximum fuel injection quantity is restricted to 50%.) c. Inducement (Severe level) <ul style="list-style-type: none"> When engine operation time is 100 hours or more from error occurrences (or 5 hours or more (*1)), Inducement level becomes Severe level. In this case, the engine speed is restricted to 60% of its rated speed (in some engine models), and the torque is restricted to 50%. (For some errors, the engine speed is restricted to low idle and the maximum fuel injection quantity is restricted to 50%.) (*1) This time indicates a case when another abnormality that results in inducement occurs within 40 hours of recovery from a previous abnormality.
Reset criteria	Yes: Reset criteria: (sensor output is lower than the 4.8 V threshold) the fault mode is automatically released.
Remarks	

● **Presumed cause of the failure or the error condition**

1. Poor connection of connector
2. Wiring failure of the wire-harness
3. EGR gas temperature sensor failure
4. ECU internal circuit failure

● **Diagnosis**

1. Initial diagnosis using SA-D	<ul style="list-style-type: none"> • Check the fault indication. • Check the sensor voltage. <p>* See Chapter 2 P382 for details on the diagnosis method and procedure.</p>
---------------------------------	---

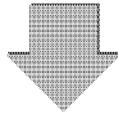

2. Connector/wiring check	<ul style="list-style-type: none"> • Before beginning your work, be sure to turn off the ECU power. • Check the pin of the EGR gas temperature sensor for deformation and cracks, the condition of the connection, and whether the retainer is loose or removed. • Make sure that the EGR gas temperature sensor wiring is not cut or the wiring coating is not peeled.
---------------------------	--

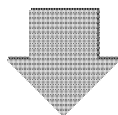

3. Failure diagnosis	<ul style="list-style-type: none"> • Check the resistance value of the EGR gas temperature sensor. • Check the conduction of the wire-harness. • Check the output voltage of the EGR gas temperature sensor. <p>* See Chapter 2 P382 for details on the diagnosis method and procedure.</p>
----------------------	--

P041C: EGR gas temperature sensor error (voltage low)

P code	P041C	Name	EGR gas temperature sensor error (voltage low)
SPN/FMI	412/4		

● DTC detection criteria

1. Prerequisite, 2. Judgment criteria	Check points
1. No prerequisite. 2. Sensor output is lower than threshold 0.2 V.	Connector Wire-harness EGR gas temperature sensor ECU

● Actions when an error occurs

Fault mode	[Limited operation]: Set the EGR gas temperature to 30 °C as default value. The engine operation is limited.
Limited operation	Yes: <ul style="list-style-type: none"> • When sensor error occurs, rated output of the engine is reduced immediately. • The maximum engine torque is limited to 85%. • EGR fully closes. • Ash amount reset is prohibited. • Rated output of the engine is reduced further after 120 min. • The maximum engine torque is limited to 50%. • Simultaneous to the above operating restrictions, engine operation restrictions are applied according to the inducement level of the EGR system abnormality. The level of restriction applied will whichever level is higher. <ul style="list-style-type: none"> a. Warning When engine operation time is less than 36 hours since abnormality occurred. In this case, restrictions on engine speed/fuel injection quantity vary depending on the error. b. Inducement (Low level) When engine operation time 36 hours or more and less than 100 hours from error occurrences (or less than 5 hours (*1)), Inducement level becomes Low level. In this case, the torque is limited to 75%. (For some errors, the engine speed is restricted to low idle and the maximum fuel injection quantity is restricted to 50%.) c. Inducement (Severe level) When engine operation time is 100 hours or more from error occurrences (or 5 hours or more (*1)), Inducement level becomes Severe level. In this case, the engine speed is restricted to 60% of its rated speed (in some engine models), and the torque is restricted to 50%. (For some errors, the engine speed is restricted to low idle and the maximum fuel injection quantity is restricted to 50%.) (*1) This time indicates a case when another abnormality that results in inducement occurs within 40 hours of recovery from a previous abnormality.
Reset criteria	Yes: Reset criteria: (sensor output is lower than the 0.2 V threshold) the fault mode is automatically released.
Remarks	

● **Presumed cause of the failure or the error condition**

1. Poor connection of connector
2. Wiring failure of the wire-harness
3. EGR gas temperature sensor failure
4. ECU internal circuit failure

● **Diagnosis**

1. Initial diagnosis using SA-D	<ul style="list-style-type: none"> • Check the fault indication. • Check the sensor voltage. <p>* See Chapter 2 P382 for details on the diagnosis method and procedure.</p>
---------------------------------	---

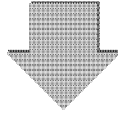

2. Connector/wiring check	<ul style="list-style-type: none"> • Before beginning your work, be sure to turn off the ECU power. • Check the pin of the EGR gas temperature sensor for deformation and cracks, the condition of the connection, and whether the retainer is loose or removed. • Make sure that the EGR gas temperature sensor wiring is not cut or the wiring coating is not peeled.
---------------------------	--

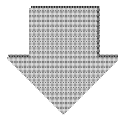

3. Failure diagnosis	<ul style="list-style-type: none"> • Check the resistance value of the EGR gas temperature sensor. • Check the conduction of the wire-harness. • Check the output voltage of the EGR gas temperature sensor. <p>* See Chapter 2 P382 for details on the diagnosis method and procedure.</p>
----------------------	--

P1675: EGR gas temperature sensor error (detected value error)

P code	P1675	Name	EGR gas temperature sensor error (detected value error)
SPN/FMI	412/10		

● Purpose of DTC detection

Compare the EGR gas temperature when the engine stops and while the engine is running. If the temperature difference is small, this error is detected. This detects errors such as the EGR gas temperature sensor falling off from the engine.

● DTC detection criteria

1. Prerequisite, 2. Judgment criteria	Check points
<p>1. The following prerequisites should be satisfied:</p> <ul style="list-style-type: none"> • No abnormalities in related sensors • Battery voltage is within the prescribed range • The last driving cycle has completely warmed up • Not during DPF regeneration • The water temperature is 40 °C or less immediately after turning the key ON • The exhaust manifold temperature is 41.2 °C or less immediately after turning the key ON • The difference between the exhaust manifold temperature and the intake air temperature immediately after turning the key ON is within ±6.6 °C • Atmospheric pressure is 82.3 kPa or more • The specified period of time has elapsed after the EGR valve opens. • With the above conditions established, the following shall be satisfied for a prescribed period of time: <ul style="list-style-type: none"> • Exhaust manifold temperature equal to or more than the prescribed value • EGR valve opening equal to or more than the prescribed value • Current injection amount is equal to or more than the predetermined value determine by the engine rpm * Completely warmed up: water temperature is 60 °C or more, and 600 seconds have elapsed since start up. <p>2. After the prerequisite conditions have been established, the following shall be satisfied.</p> <ul style="list-style-type: none"> • (current EGR gas temperature) - (EGR gas temperature immediately after key is turned ON) ≤ 40 °C 	<p>Connector Wire-harness EGR gas temperature sensor ECU</p>

● Actions when an error occurs

Fault mode	[Limited operation]: The engine operation is limited.
Limited operation	<p>Yes: • When a sensor abnormality occurs, engine operation restrictions are applied according to the inducement level of the EGR system abnormality.</p> <p>a. Warning When engine operation time is less than 36 hours since abnormality occurred. In this case, restrictions on engine speed/fuel injection quantity vary depending on the error.</p> <p>b. Inducement (Low level) When engine operation time 36 hours or more and less than 100 hours from error occurrences (or less than 5 hours (*1)), Inducement level becomes Low level. At this time, the engine torque is limited to 75% (the engine speed is limited to low idle speed in some errors while the maximum fuel injection quantity is limited to 50%.)</p> <p>c. Inducement (Severe level) When engine operation time is 100 hours or more from error occurrences (or 5 hours or more (*1)), Inducement level becomes Severe level. In this case, the engine speed is limited to 60% of its rated speed (in some engine models), and the torque is limited to 50%. (For some errors, the engine speed is restricted to low idle and the maximum fuel injection quantity is restricted to 50%.)</p> <p>(*1) This time indicates a case when another abnormality that results in inducement occurs within 40 hours of recovery from a previous abnormality.</p>
Reset criteria	Yes: After the reset conditions (prerequisites satisfied, detection conditions not satisfied?, the fault mode is automatically released.
Remarks	

● Presumed cause of the failure or the error condition

1. Installation failure of EGR gas temperature sensor
2. Poor connection of connector
3. Wiring failure of the wire-harness
4. EGR gas temperature sensor failure
5. ECU internal circuit failure

● Diagnosis

1. Initial diagnosis using SA-D	<ul style="list-style-type: none">• Check the fault indication. <p>* See Chapter 2 P386 for details on the diagnosis method and procedure.</p>
---------------------------------	--

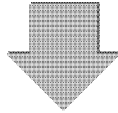

2. Engine check	<ul style="list-style-type: none">• Before beginning your work, be sure to turn off the key switch, and turn off the ECU power.• Check the installation condition of EGR gas temperature sensor.• Check the EGR pipe and EGR cooler for damage or failure.
-----------------	--

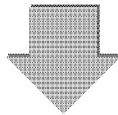

3. Connector/wiring check	<ul style="list-style-type: none">• Check the pin of the EGR gas temperature sensor for deformation and cracks, the condition of the connection, and whether the retainer is loose or removed.• Make sure that the EGR gas temperature sensor wiring is not disconnected or the wiring coating is not peeled.
---------------------------	--

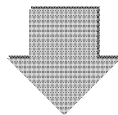

4. Failure diagnosis	<ul style="list-style-type: none">• Check the resistance value of the EGR gas temperature sensor.• Check the conduction of the wire-harness.• Check the output voltage of the EGR gas temperature sensor. <p>* See Chapter 2 P386 for details on the diagnosis method and procedure.</p>
----------------------	--

■ Intake manifold temperature sensor

P040D: Intake manifold temperature sensor error (voltage high)

P code	P040D	Name	Intake manifold temperature sensor error (voltage high)
SPN/FMI	105/3		

● DTC detection criteria

1. Prerequisite, 2. Judgment criteria	Check points
1. No prerequisite. 2. Sensor output is higher than threshold 4.8 V.	Connector Wire-harness Intake manifold temperature sensor ECU

● Actions when an error occurs

Fault mode	[Limited operation]: Intake air temperature is set to 100 °C (200 °C in the case with turbo) as the default value. The engine operation is limited.
Limited operation	Yes: <ul style="list-style-type: none"> • When sensor error occurs, rated output of the engine is reduced immediately. • The maximum engine torque is limited to 85%. • The engine speed is limited to the [maximum torque speed +200 min⁻¹]. • EGR fully closes. • Intake throttle fully opens. • DPF regeneration stops. • The accumulated PM amount calculation by DPF differential pressure stops. • Ash amount reset is prohibited. • Rated output of the engine is reduced further after 15 min. • The maximum engine torque is limited to 50%. • The engine speed is limited to the [maximum torque speed +200 min⁻¹]. • Simultaneous to the above operating restrictions, engine operation restrictions are applied according to the inducement level of the EGR system abnormality. The level of restriction applied will whichever level is higher. <ul style="list-style-type: none"> a. Warning When engine operation time is less than 36 hours since abnormality occurred. In this case, restrictions on engine speed/fuel injection quantity vary depending on the error. b. Inducement (Low level) When engine operation time 36 hours or more and less than 100 hours from error occurrences (or less than 5 hours (*1)), Inducement level becomes Low level. In this case, the torque is limited to 75%. (For some errors, the engine speed is restricted to low idle and the maximum fuel injection quantity is restricted to 50%.) c. Inducement (Severe level) When engine operation time is 100 hours or more from error occurrences (or 5 hours or more (*1)), Inducement level becomes Severe level. In this case, the engine speed is restricted to 60% of its rated speed (in some engine models), and the torque is restricted to 50%. (For some errors, the engine speed is restricted to low idle and the maximum fuel injection quantity is restricted to 50%.) <p>(*1) This time indicates a case when another abnormality that results in inducement occurs within 40 hours of recovery from a previous abnormality.</p>
Reset criteria	Yes: Reset criteria: (sensor output is lower than the 4.8 V threshold) the fault mode is automatically released.
Remarks	

● **Presumed cause of the failure or the error condition**

1. Poor connection of connector
2. Wiring failure of the wire-harness
3. Intake manifold temperature sensor failure
4. ECU internal circuit failure

● **Diagnosis**

1. Initial diagnosis using SA-D	<ul style="list-style-type: none"> • Check the fault indication. • Check the sensor voltage. <p>* See Chapter 2 <i>P391</i> for details on the diagnosis method and procedure.</p>
---------------------------------	--

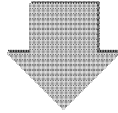

2. Connector/wiring check	<ul style="list-style-type: none"> • Before beginning your work, be sure to turn off the ECU power. • Check the pin of the intake manifold temperature sensor for deformation and cracks, the condition of the connection, and whether the retainer is loose or removed. • Make sure that the intake manifold temperature sensor wiring is not cut or the wiring coating is not peeled.
---------------------------	--

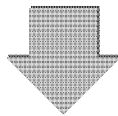

3. Failure diagnosis	<ul style="list-style-type: none"> • Check the resistance value of the intake manifold temperature sensor. • Check the conduction of the wire-harness. • Check the output voltage of the intake manifold temperature sensor. <p>* See Chapter 2 <i>P391</i> for details on the diagnosis method and procedure.</p>
----------------------	---

P040C: Intake manifold temperature sensor error (voltage low)

P code	P040C	Name	Intake manifold temperature sensor error (voltage low)
SPN/FMI	105/4		

● DTC detection criteria

1. Prerequisite, 2. Judgment criteria	Check points
1. No prerequisite. 2. Sensor output is lower than threshold 0.2 V.	Connector Wire-harness Intake manifold temperature sensor ECU

● Actions when an error occurs

Fault mode	[Limited operation]: Intake air temperature is set to 100 °C (200 °C in the case with turbo) as the default value. The engine operation is limited.
Limited operation	Yes: <ul style="list-style-type: none"> • When sensor error occurs, rated output of the engine is reduced immediately. • The maximum engine torque is limited to 85%. • The engine speed is limited to the [maximum torque speed +200 min⁻¹]. • EGR fully closes. • Intake throttle fully opens. • DPF regeneration stops. • The accumulated PM amount calculation by DPF differential pressure stops. • Ash amount reset is prohibited. • Rated output of the engine is reduced further after 15 min. • The maximum engine torque is limited to 50%. • The engine speed is limited to the [maximum torque speed +200 min⁻¹]. • Simultaneous to the above operating restrictions, engine operation restrictions are applied according to the inducement level of the EGR system abnormality. The level of restriction applied will whichever level is higher. <ul style="list-style-type: none"> a. Warning When engine operation time is less than 36 hours since abnormality occurred. In this case, restrictions on engine speed/fuel injection quantity vary depending on the error. b. Inducement (Low level) When engine operation time 36 hours or more and less than 100 hours from error occurrences (or less than 5 hours (*1)), Inducement level becomes Low level. In this case, the torque is limited to 75%. (For some errors, the engine speed is restricted to low idle and the maximum fuel injection quantity is restricted to 50%.) c. Inducement (Severe level) When engine operation time is 100 hours or more from error occurrences (or 5 hours or more (*1)), Inducement level becomes Severe level. In this case, the engine speed is restricted to 60% of its rated speed (in some engine models), and the torque is restricted to 50%. (For some errors, the engine speed is restricted to low idle and the maximum fuel injection quantity is restricted to 50%.) <p>(*1) This time indicates a case when another abnormality that results in inducement occurs within 40 hours of recovery from a previous abnormality.</p>
Reset criteria	Yes: Reset criteria: (sensor output is lower than the 0.2 V threshold) the fault mode is automatically released.
Remarks	

● Presumed cause of the failure or the error condition

1. Poor connection of connector
2. Wiring failure of the wire-harness
3. Intake manifold temperature sensor failure
4. ECU internal circuit failure

● Diagnosis

1. Initial diagnosis using SA-D	<ul style="list-style-type: none">• Check the fault indication.• Check the sensor voltage. <p>* See Chapter 2 <i>P391</i> for details on the diagnosis method and procedure.</p>
---------------------------------	---

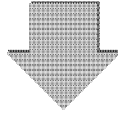

2. Connector/wiring check	<ul style="list-style-type: none">• Before beginning your work, be sure to turn off the ECU power.• Check the pin of the intake manifold temperature sensor for deformation and cracks, the condition of the connection, and whether the retainer is loose or removed.• Make sure that the intake manifold temperature sensor wiring is not cut or the wiring coating is not peeled.
---------------------------	--

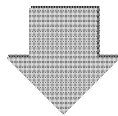

3. Failure diagnosis	<ul style="list-style-type: none">• Check the resistance value of the intake manifold temperature sensor.• Check the conduction of the wire-harness.• Check the output voltage of the intake manifold temperature sensor. <p>* See Chapter 2 <i>P391</i> for details on the diagnosis method and procedure.</p>
----------------------	---

P1676: Intake manifold temperature sensor error (detected value error)

P code	P1676	Name	Intake manifold temperature sensor error (detected value error)
SPN/FMI	105/10		

● **DTC detection criteria**

1. Prerequisite, 2. Judgment criteria	Check points
<p>1. The following prerequisites should be satisfied:</p> <ul style="list-style-type: none"> • No abnormalities in related sensors • Battery voltage is within the prescribed range • The last driving cycle has completely warmed up • The difference between the water temperature and the intake air temperature immediately after turning the key ON is within 2.5 °C * Completely warmed up: water temperature is 60 °C or more, and 600 seconds have elapsed since start up. <p>2. The difference between the intake manifold temperature and the intake air temperature immediately after turning the key ON is ± 30 °C or more.</p>	<p>Connector Wire-harness Intake manifold temperature sensor ECU</p>

● **Actions when an error occurs**

Fault mode	[Limited operation]: Intake air temperature is set to 100 °C (200 °C in the case with turbo) as the default value. The engine operation is limited.
Limited operation	<p>Yes: • When a sensor abnormality occurs, engine operation restrictions are applied according to the inducement level of the EGR system abnormality.</p> <p>a. Warning When engine operation time is less than 36 hours since abnormality occurred. In this case, restrictions on engine speed/fuel injection quantity vary depending on the error.</p> <p>b. Inducement (Low level) When engine operation time 36 hours or more and less than 100 hours from error occurrences (or less than 5 hours (*1)), Inducement level becomes Low level. At this time, the engine torque is limited to 75% (the engine speed is limited to low idle speed in some errors while the maximum fuel injection quantity is limited to 50%.)</p> <p>c. Inducement (Severe level) When engine operation time is 100 hours or more from error occurrences (or 5 hours or more (*1)), Inducement level becomes Severe level. In this case, the engine speed is limited to 60% of its rated speed (in some engine models), and the torque is limited to 50%. (For some errors, the engine speed is restricted to low idle and the maximum fuel injection quantity is restricted to 50%.)</p> <p>(*1) This time indicates a case when another abnormality that results in inducement occurs within 40 hours of recovery from a previous abnormality.</p>
Reset criteria	Yes: After the reset conditions (prerequisites satisfied, detection conditions not satisfied), the fault mode is automatically released.
Remarks	

● **Presumed cause of the failure or the error condition**

1. Installation failure of intake manifold temperature sensor
2. Poor connection of connector
3. Wiring failure of the wire-harness
4. Intake manifold temperature sensor failure
5. ECU internal circuit failure

● Diagnosis

1. Initial diagnosis using SA-D	<ul style="list-style-type: none">• Check the fault indication. <p>* See Chapter 2 <i>P395</i> for details on the diagnosis method and procedure.</p>
---------------------------------	---

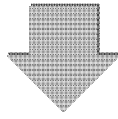

2. Engine check	<ul style="list-style-type: none">• Before beginning your work, be sure to turn off the key switch, and turn off the ECU power.• Check the installation condition of intake manifold temperature sensor.
-----------------	---

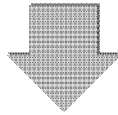

3. Connector/wiring check	<ul style="list-style-type: none">• Check the pin of the intake manifold temperature sensor for deformation and cracks, the condition of the connection, and whether the retainer is loose or removed.• Make sure that the intake manifold temperature sensor wiring is not disconnected or the wiring coating is not peeled.
---------------------------	--

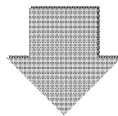

4. Failure diagnosis	<ul style="list-style-type: none">• Check the intake manifold temperature sensor resistance value.• Check the conduction of the wire-harness.• Check the intake manifold temperature sensor output voltage. <p>* See Chapter 2 <i>P395</i> for details on the diagnosis method and procedure.</p>
----------------------	---

■ Exhaust manifold temperature sensor

P0546: Exhaust manifold temperature sensor error (voltage high)

P code	P0546	Name	Exhaust manifold temperature sensor error (voltage high)
SPN/FMI	173/3		

● DTC detection criteria

1. Prerequisite, 2. Judgment criteria	Check points
1. No prerequisite. 2. Sensor output is higher than threshold 4.8 V.	Connector Wire-harness Exhaust manifold temperature sensor ECU

● Actions when an error occurs

Fault mode	[Limited operation]: The exhaust temperature is set to 550 °C as the default value. The engine operation is limited.
Limited operation	Yes: <ul style="list-style-type: none"> • When sensor error occurs, rated output of the engine is reduced immediately. <ul style="list-style-type: none"> • The maximum engine torque is limited to 85%. • EGR fully closes. • Ash amount reset is prohibited. • Rated output of the engine is reduced further after 120 min. • The maximum engine torque is limited to 50%. • Simultaneous to the above operating restrictions, engine operation restrictions are applied according to the inducement level of the EGR system abnormality. The level of restriction applied will whichever level is higher. <ul style="list-style-type: none"> a. Warning <ul style="list-style-type: none"> When engine operation time is less than 36 hours since abnormality occurred. In this case, restrictions on engine speed/fuel injection quantity vary depending on the error. b. Inducement (Low level) <ul style="list-style-type: none"> When engine operation time 36 hours or more and less than 100 hours from error occurrences (or less than 5 hours (*1)), Inducement level becomes Low level. In this case, the torque is limited to 75%. (For some errors, the engine speed is restricted to low idle and the maximum fuel injection quantity is restricted to 50%.) c. Inducement (Severe level) <ul style="list-style-type: none"> When engine operation time is 100 hours or more from error occurrences (or 5 hours or more (*1)), Inducement level becomes Severe level. In this case, the engine speed is restricted to 60% of its rated speed (in some engine models), and the torque is restricted to 50%. (For some errors, the engine speed is restricted to low idle and the maximum fuel injection quantity is restricted to 50%.) (*1) This time indicates a case when another abnormality that results in inducement occurs within 40 hours of recovery from a previous abnormality.
Reset criteria	Yes: Reset criteria: (sensor output is lower than the 4.8 V threshold) the fault mode is automatically released.
Remarks	

● **Presumed cause of the failure or the error condition**

1. Poor connection of connector
2. Wiring failure of the wire-harness
3. Exhaust manifold temperature sensor failure
4. ECU internal circuit failure

● **Diagnosis**

1. Initial diagnosis using SA-D	<ul style="list-style-type: none"> • Check the fault indication. • Check the sensor voltage. <p>* See Chapter 2 <i>P400</i> for details on the diagnosis method and procedure.</p>
---------------------------------	--

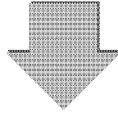

2. Connector/wiring check	<ul style="list-style-type: none"> • Before beginning your work, be sure to turn off the ECU power. • Check the pin of the exhaust manifold temperature sensor for deformation and cracks, the condition of the connection, and whether the retainer is loose or removed. • Make sure that the exhaust manifold temperature sensor wiring is not cut or the wiring coating is not peeled.
---------------------------	--

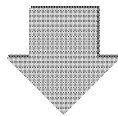

3. Failure diagnosis	<ul style="list-style-type: none"> • Check the resistance value of the exhaust manifold temperature sensor. • Check the conduction of the wire-harness. • Check the output voltage of the exhaust manifold temperature sensor. <p>* See Chapter 2 <i>P400</i> for details on the diagnosis method and procedure.</p>
----------------------	---

P0545: Exhaust manifold temperature sensor error (voltage low)

P code	P0545	Name	Exhaust manifold temperature sensor error (voltage low)
SPN/FMI	173/4		

● DTC detection criteria

1. Prerequisite, 2. Judgment criteria	Check points
1. No prerequisite. 2. Sensor output is lower than threshold 0.2 V.	Connector Wire-harness Exhaust manifold temperature sensor ECU

● Actions when an error occurs

Fault mode	[Limited operation]: The exhaust temperature is set to 550 °C as the default value. The engine operation is limited.
Limited operation	Yes: <ul style="list-style-type: none"> • When sensor error occurs, rated output of the engine is reduced immediately. • The maximum engine torque is limited to 85%. • EGR fully closes. • Ash amount reset is prohibited. • Rated output of the engine is reduced further after 120 min. • The maximum engine torque is limited to 50%. • Simultaneous to the above operating restrictions, engine operation restrictions are applied according to the inducement level of the EGR system abnormality. The level of restriction applied will whichever level is higher. <ul style="list-style-type: none"> a. Warning When engine operation time is less than 36 hours since abnormality occurred. In this case, restrictions on engine speed/fuel injection quantity vary depending on the error. b. Inducement (Low level) When engine operation time 36 hours or more and less than 100 hours from error occurrences (or less than 5 hours (*1)), Inducement level becomes Low level. In this case, the torque is limited to 75%. (For some errors, the engine speed is restricted to low idle and the maximum fuel injection quantity is restricted to 50%.) c. Inducement (Severe level) When engine operation time is 100 hours or more from error occurrences (or 5 hours or more (*1)), Inducement level becomes Severe level. In this case, the engine speed is restricted to 60% of its rated speed (in some engine models), and the torque is restricted to 50%. (For some errors, the engine speed is restricted to low idle and the maximum fuel injection quantity is restricted to 50%.) (*1) This time indicates a case when another abnormality that results in inducement occurs within 40 hours of recovery from a previous abnormality.
Reset criteria	Yes: Reset criteria: (sensor output is lower than the 0.2 V threshold) the fault mode is automatically released.
Remarks	

● **Presumed cause of the failure or the error condition**

1. Poor connection of connector
2. Wiring failure of the wire-harness
3. Exhaust manifold temperature sensor failure
4. ECU internal circuit failure

● **Diagnosis**

1. Initial diagnosis using SA-D	<ul style="list-style-type: none"> • Check the fault indication. • Check the sensor voltage. <p>* See Chapter 2 <i>P400</i> for details on the diagnosis method and procedure.</p>
---------------------------------	--

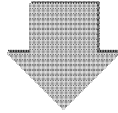

2. Connector/wiring check	<ul style="list-style-type: none"> • Before beginning your work, be sure to turn off the ECU power. • Check the pin of the exhaust manifold temperature sensor for deformation and cracks, the condition of the connection, and whether the retainer is loose or removed. • Make sure that the exhaust manifold temperature sensor wiring is not cut or the wiring coating is not peeled.
---------------------------	--

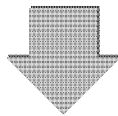

3. Failure diagnosis	<ul style="list-style-type: none"> • Check the resistance value of the exhaust manifold temperature sensor. • Check the conduction of the wire-harness. • Check the output voltage of the exhaust manifold temperature sensor. <p>* See Chapter 2 <i>P400</i> for details on the diagnosis method and procedure.</p>
----------------------	---

P1677: Exhaust manifold temperature sensor error (detected value error)

P code	P1677	Name	Exhaust manifold temperature sensor error (detected value error)
SPN/FMI	173/10		

● **Purpose of DTC detection**

Compare the exhaust manifold temperature when the engine stops and while the engine is running. If the temperature difference is small, this error is detected. This detects errors such as the exhaust manifold temperature sensor falling off from the engine.

● **DTC detection criteria**

1. Prerequisite, 2. Judgment criteria	Check points
<p>1. The following prerequisites should be satisfied:</p> <ul style="list-style-type: none"> • No abnormalities in related sensors • Battery voltage is within the prescribed range • Not during forced operation by service tool • The last driving cycle has completely warmed up • The water temperature is 40 °C or less immediately after turning the key ON • The DPF inlet temperature is 41.2 °C or less immediately after turning the key ON • The difference between the DPF inlet temperature and the intake air temperature immediately after turning the key ON is within ±6.6 °C • The current DPF inlet temperature is equal to or more than, continuously for 1 second, the DPF inlet temperature immediately after the key is turned ON. • Not during DPF regeneration • Atmospheric pressure is 82.3 kPa or more * Completely warmed up: water temperature is 60 °C or more, and 600 seconds have elapsed since start up. <p>2. After the prerequisite conditions have been established, the following shall be satisfied:</p> <ul style="list-style-type: none"> • (current exhaust manifold temperature) - (exhaust manifold temperature immediately after key is turned ON) ≤ 100 °C 	<p>Connector Wire-harness Exhaust manifold temperature sensor ECU</p>

● **Actions when an error occurs**

Fault mode	[Limited operation]: The engine operation is limited.
Limited operation	<p>Yes: • When a sensor abnormality occurs, engine operation restrictions are applied according to the inducement level of the EGR system abnormality.</p> <p>a. Warning When engine operation time is less than 36 hours since abnormality occurred. In this case, restrictions on engine speed/fuel injection quantity vary depending on the error.</p> <p>b. Inducement (Low level) When engine operation time 36 hours or more and less than 100 hours from error occurrences (or less than 5 hours (*1)), Inducement level becomes Low level. At this time, the engine torque is limited to 75% (the engine speed is limited to low idle speed in some errors while the maximum fuel injection quantity is limited to 50%.)</p> <p>c. Inducement (Severe level) When engine operation time is 100 hours or more from error occurrences (or 5 hours or more (*1)), Inducement level becomes Severe level. In this case, the engine speed is limited to 60% of its rated speed (in some engine models), and the torque is limited to 50%. (For some errors, the engine speed is restricted to low idle and the maximum fuel injection quantity is restricted to 50%.)</p> <p>(*1) This time indicates a case when another abnormality that results in inducement occurs within 40 hours of recovery from a previous abnormality.</p>
Reset criteria	Yes: After the reset conditions (prerequisites satisfied, detection conditions not satisfied), the fault mode is automatically released.
Remarks	

● Presumed cause of the failure or the error condition

1. Installation failure of exhaust manifold temperature sensor
2. Poor connection of connector
3. Wiring failure of the wire-harness
4. Exhaust manifold temperature sensor failure
5. ECU internal circuit failure

● Diagnosis

1. Initial diagnosis using SA-D	<ul style="list-style-type: none"> • Check the fault indication. <p>* See Chapter 2 <i>P404</i> for details on the diagnosis method and procedure.</p>
---------------------------------	---

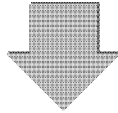

2. Engine check	<ul style="list-style-type: none"> • Before beginning your work, be sure to turn off the key switch, and turn off the ECU power. • Check the installation condition of exhaust manifold temperature sensor. • Make sure that there is nothing wrong (disconnections and damages) with the exhaust piping, pressure hose, or pressure pipe.
-----------------	---

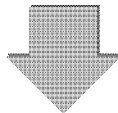

3. Connector/wiring check	<ul style="list-style-type: none"> • Check the pin of the exhaust manifold temperature sensor for deformation and cracks, the condition of the connection, and whether the retainer is loose or removed. • Make sure that the exhaust manifold temperature sensor wiring is not disconnected or the wiring coating is not peeled.
---------------------------	---

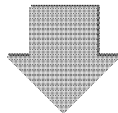

4. Failure diagnosis	<ul style="list-style-type: none"> • Check the resistance value of the exhaust manifold temperature sensor. • Check the conduction of the wire-harness. • Check the exhaust manifold temperature sensor output voltage. <p>* See Chapter 2 <i>P404</i> for details on the diagnosis method and procedure.</p>
----------------------	--

Contact output related

■ Main relay

P068B: Main relay contact sticking

P code	P068B	Name	Main relay contact sticking
SPN/FMI	1485/7		

● DTC detection criteria

1. Prerequisite, 2. Judgment criteria	Check points
1. A judgment is made when the ECU is shut off. 2. The main relay does not open after the elapse of 150 ms at the time of shutting off the ECU.	Connector Wire-harness Main relay ECU

● Actions when an error occurs

Fault mode	[Continuous operation]: Engine control is not obstructed.
Limited operation	No
Reset criteria	Yes: When the ECU power is turned off, the fault mode is released.
Remarks	

● Presumed cause of the failure or the error condition

1. Poor connection of connector
2. Wiring failure of the wire-harness
 - GND short circuit of main relay coil side downstream wire
3. Main relay contact failure
 - Main relay contact sticking
4. ECU internal circuit failure

● Diagnosis

1. Initial diagnosis using SA-D	<ul style="list-style-type: none">• Check the fault indication.• Make sure that you can log in to the SMARTASSIST-DIRECT (SA-D) after turning off the power switch and the elapse of a given period of time. <p>* See Chapter 2 <i>P409</i> for details on the diagnosis method and procedure.</p>
---------------------------------	---

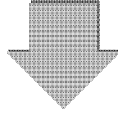

2. Connector/wiring check	<ul style="list-style-type: none">• Before beginning your work, be sure to turn off the ECU power.• Check the pin of the main relay connector for deformation and cracks, the condition of the connection, and whether the retainer is loose or removed.• Make sure that the main relay wiring is not cut or the wiring coating is not peeled.
---------------------------	--

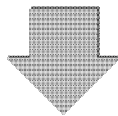

3. Failure diagnosis	<ul style="list-style-type: none">• Check the conduction of the main relay contact.• Check the main relay resistance value.• Check the conduction of the wire-harness. <p>* See Chapter 2 <i>P409</i> for details on the diagnosis method and procedure.</p>
----------------------	--

P068A: Main relay early opening

P code	P068A	Name	Main relay early opening
SPN/FMI	1485/2		

● DTC detection criteria

1. Prerequisite, 2. Judgment criteria	Check points
1. Judgment is made when the ECU is initialized. 2. ECU power shutdown without performing the after run (EEPROM write process after turning off the key switch).	Connector Wire-harness Main relay ECU

● Actions when an error occurs

Fault mode	[Continuous operation]: Engine control is not obstructed.
Limited operation	No
Reset criteria	Yes: When the ECU power is turned off, the fault mode is released.
Remarks	

● Presumed cause of the failure or the error condition

1. Poor connection of connector
2. Wiring failure of the wire-harness
 - GND short circuit of main relay coil side downstream wire
3. Main relay contact failure
 - Main relay contact sticking
4. ECU internal circuit failure

● Diagnosis

1. Initial diagnosis using SA-D	
---------------------------------	--

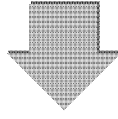

2. Connector/wiring check	<ul style="list-style-type: none">• Before beginning your work, be sure to turn off the ECU power.• Check the pin of the main relay connector for deformation and cracks, the condition of the connection, and whether the retainer is loose or removed.• Make sure that the main relay wiring is not cut or the wiring coating is not peeled.
---------------------------	--

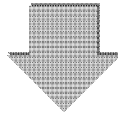

3. Failure diagnosis	<ul style="list-style-type: none">• Check the conduction of the main relay contact.• Check the main relay resistance value.• Check the conduction of the wire-harness. <p>* See Chapter 2 P409 for details on the diagnosis method and procedure.</p>
----------------------	---

■ Starting aid relay

P0543: Starting aid relay disconnection

P code	P0543	Name	Starting aid relay disconnection
SPN/FMI	522243/5		

● DTC detection criteria

1. Prerequisite, 2. Judgment criteria	Check points
1. Current is OFF in the starting aid relay. 2. IC open circuit inside the ECU is detected.	Connector Wire-harness Starting aid relay ECU

● Actions when an error occurs

Fault mode	[Continuous operation]: Engine control is not obstructed.
Limited operation	No
Reset criteria	Yes: When the ECU power is turned off, the fault mode is released.
Remarks	

● Presumed cause of the failure or the error condition

1. Poor connection of connector
2. Wiring failure of the wire-harness
 - Disconnection of starting aid relay power
 - Power short circuit of starting aid relay power
3. Starting aid relay failure
4. ECU internal circuit failure

● Diagnosis

1. Initial diagnosis using SA-D	<ul style="list-style-type: none">• Check the fault indication. <p>* See Chapter 2 P413 for details on the diagnosis method and procedure.</p>
---------------------------------	--

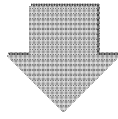

2. Connector/wiring check	<ul style="list-style-type: none">• Before beginning your work, be sure to turn off the ECU power.• Check the pin of the starting aid relay for deformation and cracks, the condition of the connection, and whether the retainer is loose or removed.• Make sure that the starting aid Relay wiring is not cut or the wiring coating is not peeled.
---------------------------	--

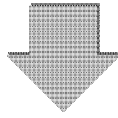

3. Failure diagnosis	<ul style="list-style-type: none">• Check the starting aid relay resistance value.• Check the conduction of the wire-harness. <p>* See Chapter 2 P413 for details on the diagnosis method and procedure.</p>
----------------------	---

P0541: Starting aid relay GND short circuit

P code	P0541	Name	Starting aid relay GND short circuit
SPN/FMI	522243/6		

● DTC detection criteria

1. Prerequisite, 2. Judgment criteria	Check points
1. Current is OFF in the starting aid relay. 2. IC open circuit inside the ECU is detected.	Connector Wire-harness Starting aid relay ECU

● Actions when an error occurs

Fault mode	[Continuous operation]: Engine control is not obstructed.
Limited operation	No
Reset criteria	Yes: When the ECU power is turned off, the fault mode is released.
Remarks	

● Presumed cause of the failure or the error condition

1. Poor connection of connector
2. Wiring failure of the wire-harness
 - GND short circuit of starting aid relay power
3. Starting aid relay failure
4. ECU internal circuit failure

● Diagnosis

1. Initial diagnosis using SA-D	<ul style="list-style-type: none">• Check the fault indication. <p>* See Chapter 2 P413 for details on the diagnosis method and procedure.</p>
---------------------------------	--

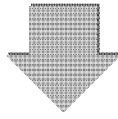

2. Connector/wiring check	<ul style="list-style-type: none">• Before beginning your work, be sure to turn off the ECU power.• Check the pin of the starting aid relay for deformation and cracks, the condition of the connection, and whether the retainer is loose or removed.• Make sure that the starting aid relay wiring is not cut or the wiring coating is not peeled.
---------------------------	--

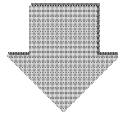

3. Failure diagnosis	<ul style="list-style-type: none">• Check the starting aid relay resistance value.• Check the conduction of the wire-harness. <p>* See Chapter 2 P413 for details on the diagnosis method and procedure.</p>
----------------------	---

CRS (common rail system) related

■ Injector (No. 1 cylinder)

P0201: Injector (No. 1 cylinder) disconnection (injector-specific)

P code	P0201	Name	Injector (No. 1 cylinder) disconnection (injector-specific)
SPN/FMI	654/5		

● DTC detection criteria

1. Prerequisite, 2. Judgment criteria	Check points
1. Pulse of camshaft/crankshaft speed sensor is detected. 2. In the drive circuit, the detection is made as an open circuit of the high side or low side.	Connector Wire-harness ECU Injector

● Actions when an error occurs

Fault mode	[Limited operation]: The engine operation is limited.
Limited operation	Yes: • When sensor error occurs, rated output of the engine is reduced immediately. • The maximum engine torque is limited to 85%. • EGR fully closes. • The fuel injection of failed cylinder terminates. • Rated output of the engine is reduced further after 120 min. • The maximum engine torque is limited to 50%.
Reset criteria	Yes: When the ECU power is turned off, the fault mode is released.
Remarks	

● Presumed cause of the failure or the error condition

1. Poor connection of connector
2. Wiring failure of the wire-harness
 - Injector drive system open circuit
3. ECU internal circuit failure
4. Disconnection of the injector internal circuit

● Diagnosis

1. Initial diagnosis using SA-D	<ul style="list-style-type: none">• Check the fault indication. <p>* See Chapter 2 <i>P440</i> for details on the diagnosis method and procedure.</p>
---------------------------------	---

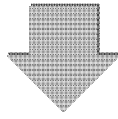

2. Connector/wiring check	<ul style="list-style-type: none">• Before beginning your work, be sure to turn off the ECU power.• Check the pin of the injector for deformation and cracks, the condition of the connection, and whether the retainer is loose or removed.• Make sure that the injector wiring is not cut or the wiring coating is not peeled.
---------------------------	--

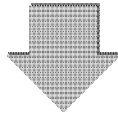

3. Failure diagnosis	<ul style="list-style-type: none">• Check the conduction of the wire-harness.• Check the injector resistance value. <p>* See Chapter 2 <i>P440</i> for details on the diagnosis method and procedure.</p>
----------------------	--

P0262: Injector (No. 1 cylinder) coil short circuit

P code	P0262	Name	Injector (No. 1 cylinder) coil short circuit
SPN/FMI	654/6		

● DTC detection criteria

1. Prerequisite, 2. Judgment criteria	Check points
1. Pulse of camshaft/crankshaft speed sensor is detected. 2. Short circuit on high side and low side of the injector coil is detected.	Connector Wire-harness ECU Injector

● Actions when an error occurs

Fault mode	[Limited operation]: The engine operation is limited.
Limited operation	Yes: <ul style="list-style-type: none"> • When sensor error occurs, rated output of the engine is reduced immediately. • The maximum engine torque is limited to 85%. • EGR fully closes. • The fuel injection of failed cylinder terminates. • Rated output of the engine is reduced further after 120 min. • The maximum engine torque is limited to 50%.
Reset criteria	Yes: When the ECU power is turned off, the fault mode is released.
Remarks	

● Presumed cause of the failure or the error condition

1. Poor connection of connector
2. Wiring failure of the wire-harness
 - Injector drive system short circuit
3. ECU internal circuit failure
4. Short circuit of the injector internal circuit

● Diagnosis

1. Initial diagnosis using SA-D	<ul style="list-style-type: none">• Check the fault indication. <p>* See Chapter 2 <i>P440</i> for details on the diagnosis method and procedure.</p>
---------------------------------	---

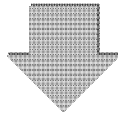

2. Connector/wiring check	<ul style="list-style-type: none">• Before beginning your work, be sure to turn off the ECU power.• Check the pin of the injector for deformation and cracks, the condition of the connection, and whether the retainer is loose or removed.• Make sure that the injector wiring is not cut or the wiring coating is not peeled.
---------------------------	--

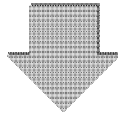

3. Failure diagnosis	<ul style="list-style-type: none">• Check the conduction of the wire-harness.• Check the injector resistance value. <p>* See Chapter 2 <i>P440</i> for details on the diagnosis method and procedure.</p>
----------------------	--

P1262: Injector (No. 1 cylinder) short circuit

P code	P1262	Name	Injector (No. 1 cylinder) short circuit
SPN/FMI	654/3		

● DTC detection criteria

1. Prerequisite, 2. Judgment criteria	Check points
1. Pulse of camshaft/crankshaft speed sensor is detected. 2. + B short circuit in the low side is detected in the drive circuit.	Connector Wire-harness ECU Injector

● Actions when an error occurs

Fault mode	[Limited operation]: The engine operation is limited.
Limited operation	Yes: <ul style="list-style-type: none"> • When sensor error occurs, rated output of the engine is reduced immediately. • The maximum engine torque is limited to 85%. • EGR fully closes. • The fuel injection of failed cylinder terminates. • Rated output of the engine is reduced further after 120 min. • The maximum engine torque is limited to 50%.
Reset criteria	Yes: When the ECU power is turned off, the fault mode is released.
Remarks	

● Presumed cause of the failure or the error condition

1. Poor connection of connector
2. Wiring failure of the wire-harness
 - Injector drive system short circuit
3. ECU internal circuit failure
4. Short circuit of the injector internal circuit

● Diagnosis

1. Initial diagnosis using SA-D	<ul style="list-style-type: none">• Check the fault indication. <p>* See Chapter 2 <i>P445</i> for details on the diagnosis method and procedure.</p>
---------------------------------	---

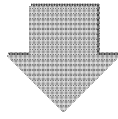

2. Connector/wiring check	<ul style="list-style-type: none">• Before beginning your work, be sure to turn off the ECU power.• Check the pin of the injector for deformation and cracks, the condition of the connection, and whether the retainer is loose or removed.• Make sure that the injector wiring is not cut or the wiring coating is not peeled.
---------------------------	--

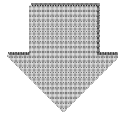

3. Failure diagnosis	<ul style="list-style-type: none">• Check the conduction of the wire-harness.• Check the injector resistance value. <p>* See Chapter 2 <i>P445</i> for details on the diagnosis method and procedure.</p>
----------------------	--

■ Injector (No. 2 cylinder)

P0202: Injector (No. 2 cylinder) disconnection (injector-specific)

P code	P0202	Name	Injector (No. 2 cylinder) disconnection (injector-specific)
SPN/FMI	653/5		

● DTC detection criteria

1. Prerequisite, 2. Judgment criteria	Check points
1. Pulse of camshaft/crankshaft speed sensor is detected. 2. In the TWV drive circuit, the detection is made as an open circuit of the high side or low side.	Connector Wire-harness ECU Injector

● Actions when an error occurs

Fault mode	[Limited operation]: The engine operation is limited.
Limited operation	Yes: • When sensor error occurs, rated output of the engine is reduced immediately. • The maximum engine torque is limited to 85%. • EGR fully closes. • The fuel injection of failed cylinder terminates. • Rated output of the engine is reduced further after 120 min. • The maximum engine torque is limited to 50%.
Reset criteria	Yes: When the ECU power is turned off, the fault mode is released.
Remarks	

● Presumed cause of the failure or the error condition

1. Poor connection of connector
2. Wiring failure of the wire-harness
 - Injector drive system open circuit
3. ECU internal circuit failure
4. Disconnection of the injector internal circuit

● Diagnosis

1. Initial diagnosis using SA-D	<ul style="list-style-type: none">• Check the fault indication. <p>* See Chapter 2 <i>P440</i> for details on the diagnosis method and procedure.</p>
---------------------------------	---

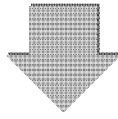

2. Connector/wiring check	<ul style="list-style-type: none">• Before beginning your work, be sure to turn off the ECU power.• Check the pin of the injector for deformation and cracks, the condition of the connection, and whether the retainer is loose or removed.• Make sure that the injector wiring is not cut or the wiring coating is not peeled.
---------------------------	--

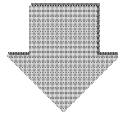

3. Failure diagnosis	<ul style="list-style-type: none">• Check the conduction of the wire-harness.• Check the injector resistance value. <p>* See Chapter 2 <i>P440</i> for details on the diagnosis method and procedure.</p>
----------------------	--

P0265: Injector (No. 2 cylinder) coil short circuit

P code	P0265	Name	Injector (No. 2 cylinder) coil short circuit
SPN/FMI	653/6		

● DTC detection criteria

1. Prerequisite, 2. Judgment criteria	Check points
1. Pulse of camshaft/crankshaft speed sensor is detected. 2. Short circuit on high side and low side of the injector coil is detected.	Connector Wire-harness ECU Injector

● Actions when an error occurs

Fault mode	[Limited operation]: The engine operation is limited.
Limited operation	Yes: <ul style="list-style-type: none"> • When sensor error occurs, rated output of the engine is reduced immediately. • The maximum engine torque is limited to 85%. • EGR fully closes. • The fuel injection of failed cylinder terminates. • Rated output of the engine is reduced further after 120 min. • The maximum engine torque is limited to 50%.
Reset criteria	Yes: When the ECU power is turned off, the fault mode is released.
Remarks	

● Presumed cause of the failure or the error condition

1. Poor connection of connector
2. Wiring failure of the wire-harness
 - Injector drive system short circuit
3. ECU internal circuit failure
4. Short circuit of the injector internal circuit

● Diagnosis

1. Initial diagnosis using SA-D	<ul style="list-style-type: none">• Check the fault indication. <p>* See Chapter 2 <i>P440</i> for details on the diagnosis method and procedure.</p>
---------------------------------	---

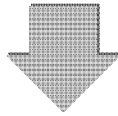

2. Connector/wiring check	<ul style="list-style-type: none">• Before beginning your work, be sure to turn off the ECU power.• Check the pin of the injector for deformation and cracks, the condition of the connection, and whether the retainer is loose or removed.• Make sure that the injector wiring is not cut or the wiring coating is not peeled.
---------------------------	--

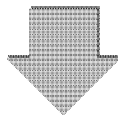

3. Failure diagnosis	<ul style="list-style-type: none">• Check the conduction of the wire-harness.• Check the injector resistance value. <p>* See Chapter 2 <i>P440</i> for details on the diagnosis method and procedure.</p>
----------------------	--

P1265: Injector (No. 2 cylinder) short circuit

P code	P1265	Name	Injector (No. 2 cylinder) short circuit
SPN/FMI	653/3		

● DTC detection criteria

1. Prerequisite, 2. Judgment criteria	Check points
1. Pulse of camshaft/crankshaft speed sensor is detected. 2. + B short circuit in the low side is detected in the drive circuit.	Connector Wire-harness ECU Injector

● Actions when an error occurs

Fault mode	[Limited operation]: The engine operation is limited.
Limited operation	Yes: <ul style="list-style-type: none"> • When sensor error occurs, rated output of the engine is reduced immediately. • The maximum engine torque is limited to 85%. • EGR fully closes. • The fuel injection of failed cylinder terminates. • Rated output of the engine is reduced further after 120 min. • The maximum engine torque is limited to 50%.
Reset criteria	Yes: When the ECU power is turned off, the fault mode is released.
Remarks	

● Presumed cause of the failure or the error condition

1. Poor connection of connector
2. Wiring failure of the wire-harness
 - Injector drive system short circuit
3. ECU internal circuit failure
4. Short circuit of the injector internal circuit

● Diagnosis

1. Initial diagnosis using SA-D	<ul style="list-style-type: none">• Check the fault indication. <p>* See Chapter 2 <i>P445</i> for details on the diagnosis method and procedure.</p>
---------------------------------	---

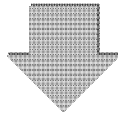

2. Connector/wiring check	<ul style="list-style-type: none">• Before beginning your work, be sure to turn off the ECU power.• Check the pin of the injector for deformation and cracks, the condition of the connection, and whether the retainer is loose or removed.• Make sure that the injector wiring is not cut or the wiring coating is not peeled.
---------------------------	--

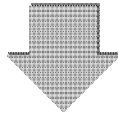

3. Failure diagnosis	<ul style="list-style-type: none">• Check the conduction of the wire-harness.• Check the injector resistance value. <p>* See Chapter 2 <i>P445</i> for details on the diagnosis method and procedure.</p>
----------------------	--

■ **Injector (No. 3 cylinder)**

P0203: Injector (No. 3 cylinder) disconnection (injector-specific)

P code	P0203	Name	Injector (No. 3 cylinder) disconnection (injector-specific)
SPN/FMI	652/5		

● **DTC detection criteria**

1. Prerequisite, 2. Judgment criteria	Check points
1. Pulse of camshaft/crankshaft speed sensor is detected. 2. In the drive circuit, the detection is made as an open circuit of the high side or low side.	Connector Wire-harness ECU Injector

● **Actions when an error occurs**

Fault mode	[Limited operation]: The engine operation is limited.
Limited operation	Yes: • When sensor error occurs, rated output of the engine is reduced immediately. • The maximum engine torque is limited to 85%. • EGR fully closes. • The fuel injection of failed cylinder terminates. • Rated output of the engine is reduced further after 120 min. • The maximum engine torque is limited to 50%.
Reset criteria	Yes: When the ECU power is turned off, the fault mode is released.
Remarks	

● **Presumed cause of the failure or the error condition**

1. Poor connection of connector
2. Wiring failure of the wire-harness
 - Injector drive system open circuit
3. ECU internal circuit failure
4. Disconnection of the injector internal circuit

● Diagnosis

1. Initial diagnosis using SA-D	<ul style="list-style-type: none">• Check the fault indication. <p>* See Chapter 2 <i>P440</i> for details on the diagnosis method and procedure.</p>
---------------------------------	---

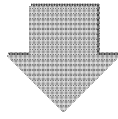

2. Connector/wiring check	<ul style="list-style-type: none">• Before beginning your work, be sure to turn off the ECU power.• Check the pin of the injector for deformation and cracks, the condition of the connection, and whether the retainer is loose or removed.• Make sure that the injector wiring is not cut or the wiring coating is not peeled.
---------------------------	--

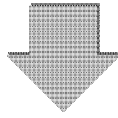

3. Failure diagnosis	<ul style="list-style-type: none">• Check the conduction of the wire-harness.• Check the injector resistance value. <p>* See Chapter 2 <i>P440</i> for details on the diagnosis method and procedure.</p>
----------------------	--

P0268: Injector (No. 3 cylinder) coil short circuit

P code	P0268	Name	Injector (No. 3 cylinder) coil short circuit
SPN/FMI	652/6		

● DTC detection criteria

1. Prerequisite, 2. Judgment criteria	Check points
1. Pulse of camshaft/crankshaft speed sensor is detected. 2. Short circuit on high side and low side of the injector coil is detected.	Connector Wire-harness ECU Injector

● Actions when an error occurs

Fault mode	[Limited operation]: The engine operation is limited.
Limited operation	Yes: <ul style="list-style-type: none"> • When sensor error occurs, rated output of the engine is reduced immediately. • The maximum engine torque is limited to 85%. • EGR fully closes. • The fuel injection of failed cylinder terminates. • Rated output of the engine is reduced further after 120 min. • The maximum engine torque is limited to 50%.
Reset criteria	Yes: When the ECU power is turned off, the fault mode is released.
Remarks	

● Presumed cause of the failure or the error condition

1. Poor connection of connector
2. Wiring failure of the wire-harness
 - Injector drive system short circuit
3. ECU internal circuit failure
4. Short circuit of the injector internal circuit

● Diagnosis

1. Initial diagnosis using SA-D	<ul style="list-style-type: none">• Check the fault indication. <p>* See Chapter 2 <i>P440</i> for details on the diagnosis method and procedure.</p>
---------------------------------	---

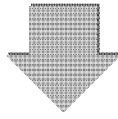

2. Connector/wiring check	<ul style="list-style-type: none">• Before beginning your work, be sure to turn off the ECU power.• Check the pin of the injector for deformation and cracks, the condition of the connection, and whether the retainer is loose or removed.• Make sure that the injector wiring is not cut or the wiring coating is not peeled.
---------------------------	--

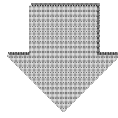

3. Failure diagnosis	<ul style="list-style-type: none">• Check the conduction of the wire-harness.• Check the injector resistance value. <p>* See Chapter 2 <i>P440</i> for details on the diagnosis method and procedure.</p>
----------------------	--

P1268: Injector (No. 3 cylinder) short circuit

P code	P1268	Name	Injector (No. 3 cylinder) short circuit
SPN/FMI	652/3		

● DTC detection criteria

1. Prerequisite, 2. Judgment criteria	Check points
1. Pulse of camshaft/crankshaft speed sensor is detected. 2. + B short circuit in the low side is detected in the drive circuit.	Connector Wire-harness ECU Injector

● Actions when an error occurs

Fault mode	[Limited operation]: The engine operation is limited.
Limited operation	Yes: <ul style="list-style-type: none"> • When sensor error occurs, rated output of the engine is reduced immediately. • The maximum engine torque is limited to 85%. • EGR fully closes. • The fuel injection of failed cylinder terminates. • Rated output of the engine is reduced further after 120 min. • The maximum engine torque is limited to 50%.
Reset criteria	Yes: When the ECU power is turned off, the fault mode is released.
Remarks	

● Presumed cause of the failure or the error condition

1. Poor connection of connector
2. Wiring failure of the wire-harness
 - Injector drive system short circuit
3. ECU internal circuit failure
4. Short circuit of the injector internal circuit

● Diagnosis

1. Initial diagnosis using SA-D	<ul style="list-style-type: none">• Check the fault indication. <p>* See Chapter 2 <i>P445</i> for details on the diagnosis method and procedure.</p>
---------------------------------	---

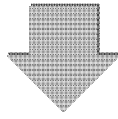

2. Connector/wiring check	<ul style="list-style-type: none">• Before beginning your work, be sure to turn off the ECU power.• Check the pin of the injector for deformation and cracks, the condition of the connection, and whether the retainer is loose or removed.• Make sure that the injector wiring is not cut or the wiring coating is not peeled.
---------------------------	--

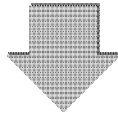

3. Failure diagnosis	<ul style="list-style-type: none">• Check the conduction of the wire-harness.• Check the injector resistance value. <p>* See Chapter 2 <i>P445</i> for details on the diagnosis method and procedure.</p>
----------------------	--

■ Injector (No. 4 cylinder)

P0204: Injector (No. 4 cylinder) disconnection (injector-specific)

P code	P0204	Name	Injector (No. 4 cylinder) disconnection (injector-specific)
SPN/FMI	651/5		

● DTC detection criteria

1. Prerequisite, 2. Judgment criteria	Check points
1. Pulse of camshaft/crankshaft speed sensor is detected. 2. In the drive circuit, the detection is made as an open circuit of the high side or low side.	Connector Wire-harness ECU Injector

● Actions when an error occurs

Fault mode	[Limited operation]: The engine operation is limited.
Limited operation	Yes: • When sensor error occurs, rated output of the engine is reduced immediately. • The maximum engine torque is limited to 85%. • EGR fully closes. • The fuel injection of failed cylinder terminates. • Rated output of the engine is reduced further after 120 min. • The maximum engine torque is limited to 50%.
Reset criteria	Yes: When the ECU power is turned off, the fault mode is released.
Remarks	

● Presumed cause of the failure or the error condition

1. Poor connection of connector
2. Wiring failure of the wire-harness
 - Injector drive system open circuit
3. ECU internal circuit failure
4. Disconnection of the injector internal circuit

● Diagnosis

1. Initial diagnosis using SA-D	<ul style="list-style-type: none">• Check the fault indication. <p>* See Chapter 2 <i>P440</i> for details on the diagnosis method and procedure.</p>
---------------------------------	---

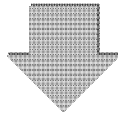

2. Connector/wiring check	<ul style="list-style-type: none">• Before beginning your work, be sure to turn off the ECU power.• Check the pin of the injector for deformation and cracks, the condition of the connection, and whether the retainer is loose or removed.• Make sure that the injector wiring is not cut or the wiring coating is not peeled.
---------------------------	--

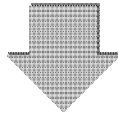

3. Failure diagnosis	<ul style="list-style-type: none">• Check the conduction of the wire-harness.• Check the injector resistance value. <p>* See Chapter 2 <i>P440</i> for details on the diagnosis method and procedure.</p>
----------------------	--

P0271: Injector (No. 4 cylinder) coil short circuit

P code	P0271	Name	Injector (No. 4 cylinder) coil short circuit
SPN/FMI	651/6		

● DTC detection criteria

1. Prerequisite, 2. Judgment criteria	Check points
1. Pulse of camshaft/crankshaft speed sensor is detected. 2. Short circuit on high side and low side of the injector coil is detected.	Connector Wire-harness ECU Injector

● Actions when an error occurs

Fault mode	[Limited operation]: The engine operation is limited.
Limited operation	Yes: <ul style="list-style-type: none"> • When sensor error occurs, rated output of the engine is reduced immediately. • The maximum engine torque is limited to 85%. • EGR fully closes. • The fuel injection of failed cylinder terminates. • Rated output of the engine is reduced further after 120 min. • The maximum engine torque is limited to 50%.
Reset criteria	Yes: When the ECU power is turned off, the fault mode is released.
Remarks	

● Presumed cause of the failure or the error condition

1. Poor connection of connector
2. Wiring failure of the wire-harness
 - Injector drive system short circuit
3. ECU internal circuit failure
4. Short circuit of the injector internal circuit

● Diagnosis

1. Initial diagnosis using SA-D	<ul style="list-style-type: none">• Check the fault indication. <p>* See Chapter 2 <i>P440</i> for details on the diagnosis method and procedure.</p>
---------------------------------	---

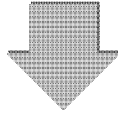

2. Connector/wiring check	<ul style="list-style-type: none">• Before beginning your work, be sure to turn off the ECU power.• Check the pin of the injector for deformation and cracks, the condition of the connection, and whether the retainer is loose or removed.• Make sure that the injector wiring is not cut or the wiring coating is not peeled.
---------------------------	--

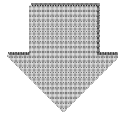

3. Failure diagnosis	<ul style="list-style-type: none">• Check the conduction of the wire-harness.• Check the injector resistance value. <p>* See Chapter 2 <i>P440</i> for details on the diagnosis method and procedure.</p>
----------------------	--

P1271: Injector (No. 4 cylinder) short circuit

P code	P1271	Name	Injector (No. 4 cylinder) short circuit
SPN/FMI	651/3		

● DTC detection criteria

1. Prerequisite, 2. Judgment criteria	Check points
1. Pulse of camshaft/crankshaft speed sensor is detected. 2. + B short circuit in the low side is detected in the drive circuit.	Connector Wire-harness ECU Injector

● Actions when an error occurs

Fault mode	[Limited operation]: The engine operation is limited.
Limited operation	Yes: <ul style="list-style-type: none"> • When sensor error occurs, rated output of the engine is reduced immediately. • The maximum engine torque is limited to 85%. • EGR fully closes. • The fuel injection of failed cylinder terminates. • Rated output of the engine is reduced further after 120 min. • The maximum engine torque is limited to 50%.
Reset criteria	Yes: When the ECU power is turned off, the fault mode is released.
Remarks	

● Presumed cause of the failure or the error condition

1. Poor connection of connector
2. Wiring failure of the wire-harness
 - Injector drive system short circuit
3. ECU internal circuit failure
4. Short circuit of the injector internal circuit

● Diagnosis

1. Initial diagnosis using SA-D	<ul style="list-style-type: none">• Check the fault indication. <p>* See Chapter 2 <i>P445</i> for details on the diagnosis method and procedure.</p>
---------------------------------	---

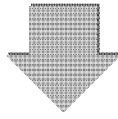

2. Connector/wiring check	<ul style="list-style-type: none">• Before beginning your work, be sure to turn off the ECU power.• Check the pin of the injector for deformation and cracks, the condition of the connection, and whether the retainer is loose or removed.• Make sure that the injector wiring is not cut or the wiring coating is not peeled.
---------------------------	--

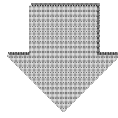

3. Failure diagnosis	<ul style="list-style-type: none">• Check the conduction of the wire-harness.• Check the injector resistance value. <p>* See Chapter 2 <i>P445</i> for details on the diagnosis method and procedure.</p>
----------------------	--

■ All injectors

P0611: Injector drive IC error

P code	P0611	Name	Injector drive IC error
SPN/FMI	4257/12		

● DTC detection criteria

1. Prerequisite, 2. Judgment criteria	Check points
1. Pulse of camshaft/crankshaft speed sensor is detected. 2. ECU detects the drive IC fault.	

● Actions when an error occurs

Fault mode	[Limited operation]: The engine operation is limited.
Limited operation	Yes: <ul style="list-style-type: none"> • When sensor error occurs, rated output of the engine is reduced immediately. • The maximum engine torque is limited to 85%. • EGR fully closes. • The failed bank injection terminates. • Rated output of the engine is reduced further after 120 min. • The maximum engine torque is limited to 50%.
Reset criteria	When the ECU power is turned off, the fault mode is released.
Remarks	

● Presumed cause of the failure or the error condition

P1146: Injector drive circuit (Bank 1) short circuit

P code	P1146	Name	Injector drive circuit (Bank 1) short circuit
SPN/FMI	2797/6		

● **DTC detection criteria**

1. Prerequisite, 2. Judgment criteria	Check points
1. Pulse of camshaft/crankshaft speed sensor is detected. 2. In the drive circuit, the detection is made as a GND short circuit of the high side or low side, or +B short circuit of the high side.	Connector Wire-harness Injector ECU

● **Actions when an error occurs**

Fault mode	[Limited operation]: The engine operation is limited.
Limited operation	Yes: • When sensor error occurs, rated output of the engine is reduced immediately. • The maximum engine torque is limited to 85%. • EGR fully closes. • The failed bank injection terminates. • Rated output of the engine is reduced further after 120 min. • The maximum engine torque is limited to 50%.
Reset criteria	Yes: When the ECU power is turned off, the fault mode is released.
Remarks	

● **Presumed cause of the failure or the error condition**

1. Poor connection of connector
2. Wiring failure of the wire-harness
 - Power short circuit of the high side of the injector Bank 1
 - GND short circuit of the high side of the injector Bank 1
 - Power short circuit of the low side of the injector Bank 1
 - GND short circuit of the low side of the injector Bank 1
3. Injector failure by power short circuit
4. ECU internal circuit failure

● Diagnosis

1. Initial diagnosis using SA-D	<ul style="list-style-type: none">• Check the fault indication. <p>* See Chapter 2 P445 for details on the diagnosis method and procedure.</p>
---------------------------------	--

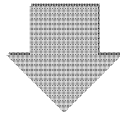

2. Connector/wiring check	<ul style="list-style-type: none">• Before beginning your work, be sure to turn off the ECU power.• Check the pin of the injector for deformation and cracks, the condition of the connection, and whether the retainer is loose or removed.• Make sure that the injector wiring is not cut or the wiring coating is not peeled.
---------------------------	--

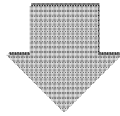

3. Failure diagnosis	<ul style="list-style-type: none">• Check the conduction of the wire-harness.• Check the injector resistance value. <p>* See Chapter 2 P445 for details on the diagnosis method and procedure.</p>
----------------------	---

P1149: Injector drive circuit (Bank 2) short circuit

P code	P1149	Name	Injector drive circuit (Bank 2) short circuit
SPN/FMI	2798/6		

● **DTC detection criteria**

1. Prerequisite, 2. Judgment criteria	Check points
1. Pulse of camshaft/crankshaft speed sensor is detected. 2. In the drive circuit, the detection is made as a GND short circuit of the high side or low side, or +B short circuit of the high side.	Connector Wire-harness Injector ECU

● **Actions when an error occurs**

Fault mode	[Limited operation]: The engine operation is limited.
Limited operation	Yes: • When sensor error occurs, rated output of the engine is reduced immediately. • The maximum engine torque is limited to 85%. • EGR fully closes. • The failed bank injection terminates. • Rated output of the engine is reduced further after 120 min. • The maximum engine torque is limited to 50%.
Reset criteria	Yes: When the ECU power is turned off, the fault mode is released.
Remarks	

● **Presumed cause of the failure or the error condition**

1. Poor connection of connector
2. Wiring failure of the wire-harness
 - Power short circuit of the high side of the injector Bank 2
 - GND short circuit of the high side of the injector Bank 2
 - Power short circuit of the low side of the injector Bank 2
 - GND short circuit of the low side of the injector Bank 2
3. Injector failure by power short circuit
4. ECU internal circuit failure

● Diagnosis

1. Initial diagnosis using SA-D	<ul style="list-style-type: none">• Check the fault indication. <p>* See Chapter 2 <i>P445</i> for details on the diagnosis method and procedure.</p>
---------------------------------	---

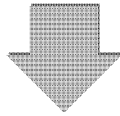

2. Connector/wiring check	<ul style="list-style-type: none">• Before beginning your work, be sure to turn off the ECU power.• Check the pin of the injector for deformation and cracks, the condition of the connection, and whether the retainer is loose or removed.• Make sure that the injector wiring is not cut or the wiring coating is not peeled.
---------------------------	--

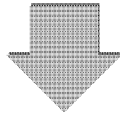

3. Failure diagnosis	<ul style="list-style-type: none">• Check the conduction of the wire-harness.• Check the injector resistance value. <p>* See Chapter 2 <i>P445</i> for details on the diagnosis method and procedure.</p>
----------------------	--

P1648: Injector (No. 1 cylinder) correction value error

P code	P1648	Name	Injector (No. 1 cylinder) correction value error
SPN/FMI	523462/13		

● **DTC detection criteria**

1. Prerequisite, 2. Judgment criteria	Check points
1. During EEPROM initialization or value input. 2. The injector corrected value is not or mistakenly entered, and the EEPROM cannot be read.	ECU

● **Actions when an error occurs**

Fault mode	[Engine stop]: The engine operation stops.
Limited operation	Yes: Fuel injection stops.
Reset criteria	Yes: When the ECU power is turned off, the fault mode is released.
Remarks	

● **Presumed cause of the failure or the error condition**

1. Input failure of the injector correction value
2. ECU internal circuit failure

● **Diagnosis**

1. Initial diagnosis using SA-D	<ul style="list-style-type: none"> • Check the fault indication. Input the injector correction value again. • Switch the ECU power from ON to OFF to check the fault indication again. • If this DTC is detected again, exchange the ECU.
---------------------------------	--

P1649: Injector (No. 2 cylinder) correction value error

P code	P1649	Name	Injector (No. 2 cylinder) correction value error
SPN/FMI	523463/13		

● DTC detection criteria

1. Prerequisite, 2. Judgment criteria	Check points
1. During EEPROM initialization or value input. 2. The injector corrected value is not or mistakenly entered, and the EEPROM cannot be read.	ECU

● Actions when an error occurs

Fault mode	[Engine stop]: The engine operation stops.
Limited operation	Yes: Fuel injection stops.
Reset criteria	Yes: When the ECU power is turned off, the fault mode is released.
Remarks	

● Presumed cause of the failure or the error condition

1. Input failure of the injector correction value
2. ECU internal circuit failure

● Diagnosis

1. Initial diagnosis using SA-D	<ul style="list-style-type: none"> • Check the fault indication. Input the injector correction value again. • Switch the ECU power from ON to OFF to check the fault indication again. • If this DTC is detected again, exchange the ECU.
---------------------------------	--

P1650: Injector (No. 3 cylinder) correction value error

P code	P1650	Name	Injector (No. 3 cylinder) correction value error
SPN/FMI	523464/13		

● DTC detection criteria

1. Prerequisite, 2. Judgment criteria	Check points
1. During EEPROM initialization or value input. 2. The injector corrected value is not or mistakenly entered, and the EEPROM cannot be read.	ECU

● Actions when an error occurs

Fault mode	[Engine stop]: The engine operation stops.
Limited operation	Yes: Fuel injection stops.
Reset criteria	Yes: When the ECU power is turned off, the fault mode is released.
Remarks	

● Presumed cause of the failure or the error condition

1. Input failure of the injector correction value
2. ECU internal circuit failure

● Diagnosis

1. Initial diagnosis using SA-D	<ul style="list-style-type: none"> • Check the fault indication. Input the injector correction value again. • Switch the ECU power from ON to OFF to check the fault indication again. • If this DTC is detected again, exchange the ECU.
---------------------------------	--

P1651: Injector (No. 4 cylinder) correction value error

P code	P1651	Name	Injector (No. 4 cylinder) correction value error
SPN/FMI	523465/13		

● DTC detection criteria

1. Prerequisite, 2. Judgment criteria	Check points
1. During EEPROM initialization or value input. 2. The injector corrected value is not or mistakenly entered, and the EEPROM cannot be read.	ECU

● Actions when an error occurs

Fault mode	[Engine stop]: The engine operation stops.
Limited operation	Yes: Fuel injection stops.
Reset criteria	Yes: When the ECU power is turned off, the fault mode is released.
Remarks	

● Presumed cause of the failure or the error condition

1. Input failure of the injector correction value
2. ECU internal circuit failure

● Diagnosis

1. Initial diagnosis using SA-D	<ul style="list-style-type: none"> • Check the fault indication. Input the injector correction value again. • Switch the ECU power from ON to OFF to check the fault indication again. • If this DTC is detected again, exchange the ECU.
---------------------------------	--

■ SCV (MPROP)

P1641: SCV (MPROP) L side VB short circuit

P code	P1641	Name	SCV (MPROP) L side VB short circuit
SPN/FMI	522571/3		

● DTC detection criteria

1. Prerequisite, 2. Judgment criteria	Check points
1. No prerequisite. 2. The low side VB short circuit in the high pressure pump drive circuit continues for a given period of time (300 s).	Connector Wire-harness Injector ECU

● Actions when an error occurs

Fault mode	[Limited operation]: The engine operation is limited.
Limited operation	Yes: <ul style="list-style-type: none"> • When sensor error occurs, rated output of the engine is reduced immediately. • The maximum engine torque is limited to 85%. • The engine speed is limited to the [maximum torque speed +200 min⁻¹]. • EGR fully closes. • DPF regeneration stops. • Rated output of the engine is reduced further after 15 min. • The maximum engine torque is limited to 50%. • The engine speed is limited to the [maximum torque speed +200 min⁻¹].
Reset criteria	Yes: When the ECU power off is detected, the fault mode is released.
Remarks	

● Presumed cause of the failure or the error condition

1. Poor connection of connector
2. Wiring failure of the wire-harness
 - Power short circuit of the SCV (MPROP) low side
3. SCV (MPROP) failure by the power short circuit
4. ECU internal circuit failure

P1643: SCV (MPROP) L side GND short circuit

P code	P1643	Name	SCV (MPROP) L side GND short circuit
SPN/FMI	522571/6		

● DTC detection criteria

1. Prerequisite, 2. Judgment criteria	Check points
1. No prerequisite. 2. GND short circuit continues for fixed number of tests (5 times) at a fixed interval (1.0 seconds).	Connector Wire-harness SCV (MPROP) ECU

● Actions when an error occurs

Fault mode	[Limited operation]: The engine operation is limited.
Limited operation	Yes: <ul style="list-style-type: none"> • When sensor error occurs, rated output of the engine is reduced immediately. • The maximum engine torque is limited to 85%. • The engine speed is limited to the [maximum torque speed +200 min⁻¹]. • EGR fully closes. • DPF regeneration stops. • Rated output of the engine is reduced further after 15 min. • The maximum engine torque is limited to 50%. • The engine speed is limited to the [maximum torque speed +200 min⁻¹].
Reset criteria	Yes: When the ECU power off is detected, the fault mode is released.
Remarks	

● Presumed cause of the failure or the error condition

1. Poor connection of connector
2. Wiring failure of the wire-harness
 - GND short circuit of the low side wiring of SCV (MPROP)
3. SCV (MPROP) low side GND short circuit
4. ECU internal circuit failure

● Diagnosis

1. Initial diagnosis using SA-D	<ul style="list-style-type: none">• Check the fault indication. <p>* See Chapter 2 <i>P447</i> for details on the diagnosis method and procedure.</p>
---------------------------------	---

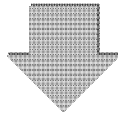

2. Connector/wiring check	<ul style="list-style-type: none">• Before beginning your work, be sure to turn off the ECU power.• Check the pin of the SCV (MPROP) for deformation and cracks, the condition of the connection, and whether the retainer is loose or removed.• Make sure that the SCV (MPROP) wiring is not shorted to the ground line or the wiring coating is not peeled.
---------------------------	---

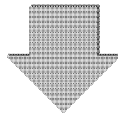

3. Failure diagnosis	<ul style="list-style-type: none">• Check the conduction of the wire-harness.• Check the SCV (MPROP) resistance value. <p>* See Chapter 2 <i>P447</i> for details on the diagnosis method and procedure.</p>
----------------------	---

P0629: SCV (MPROP) H side VB short circuit

P code	P0629	Name	SCV (MPROP) H side VB short circuit
SPN/FMI	633/3		

● DTC detection criteria

1. Prerequisite, 2. Judgment criteria	Check points
1. No prerequisite. 2. VB short circuit continues for a fixed time (300 ms).	Connector Wire-harness SCV (MPROP) ECU

● Actions when an error occurs

Fault mode	[Limited operation]: The engine operation is limited.
Limited operation	Yes: <ul style="list-style-type: none"> • When sensor error occurs, rated output of the engine is reduced immediately. • The maximum engine torque is limited to 85%. • The engine speed is limited to the [maximum torque speed +200 min⁻¹]. • EGR fully closes. • DPF regeneration stops. • Rated output of the engine is reduced further after 15 min. • The maximum engine torque is limited to 50%. • The engine speed is limited to the [maximum torque speed +200 min⁻¹].
Reset criteria	Yes: When the ECU power off is detected, the fault mode is released.
Remarks	

● Presumed cause of the failure or the error condition

1. Poor connection of connector
2. Wiring failure of the wire-harness
 - Power short circuit of SCV (+) output
 - Power short circuit of SVC (-) output
3. SCV failure caused by a coil short circuit
4. ECU internal circuit failure

● Diagnosis

1. Initial diagnosis using SA-D	<ul style="list-style-type: none">• Check the fault indication. <p>* See Chapter 2 <i>P447</i> for details on the diagnosis method and procedure.</p>
---------------------------------	---

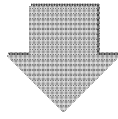

2. Connector/wiring check	<ul style="list-style-type: none">• Before beginning your work, be sure to turn off the power switch.• Check the pin of the SCV for deformation and cracks, the condition of the connection, and whether the retainer is loose or removed.• Make sure that the SCV wiring is not cut or the wiring coating is not peeled.
---------------------------	---

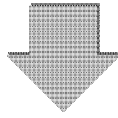

3. Failure diagnosis	<ul style="list-style-type: none">• Check the conduction of the wire-harness.• Check the SCV resistance value. <p>* See Chapter 2 <i>P447</i> for details on the diagnosis method and procedure.</p>
----------------------	---

P1642: SCV (MPROP) H side GND short circuit

P code	P1642	Name	SCV (MPROP) H side GND short circuit
SPN/FMI	633/6		

● DTC detection criteria

1. Prerequisite, 2. Judgment criteria	Check points
1. No prerequisite. 2. GND short circuit continues for fixed number of tests (5 times) at a fixed interval (1.0 seconds).	Connector Wire-harness SCV (MPROP) ECU

● Actions when an error occurs

Fault mode	[Limited operation]: The engine operation is limited.
Limited operation	Yes: <ul style="list-style-type: none"> • When sensor error occurs, rated output of the engine is reduced immediately. • The maximum engine torque is limited to 85%. • The engine speed is limited to the [maximum torque speed +200 min⁻¹]. • EGR fully closes. • DPF regeneration stops. • Rated output of the engine is reduced further after 15 min. • The maximum engine torque is limited to 50%. • The engine speed is limited to the [maximum torque speed +200 min⁻¹].
Reset criteria	Yes: When the ECU power off is detected, the fault mode is released.
Remarks	

● Presumed cause of the failure or the error condition

1. Poor connection of connector
2. Wiring failure of the wire-harness
 - Power short circuit of the SCV (MPROP) high side
3. SCV (MPROP) failure by the power short circuit
4. ECU internal circuit failure

P064A: SCV (MPROP) H side - L side short circuit

P code	P064A	Name	SCV (MPROP) H side - L side short circuit
SPN/FMI	633/2		

● **DTC detection criteria**

1. Prerequisite, 2. Judgment criteria	Check points
1. No prerequisite. 2. H side - L side short circuit continues for a specified period of time.	Connector Wire-harness SCV (MPROP) ECU

● **Actions when an error occurs**

Fault mode	[Limited operation]: The engine operation is limited.
Limited operation	Yes: <ul style="list-style-type: none"> • When sensor error occurs, rated output of the engine is reduced immediately. • The maximum engine torque is limited to 85%. • The engine speed is limited to the [maximum torque speed +200 min⁻¹]. • EGR fully closes. • DPF regeneration stops. • Rated output of the engine is reduced further after 15 min. • The maximum engine torque is limited to 50%. • The engine speed is limited to the [maximum torque speed +200 min⁻¹].
Reset criteria	Yes: When the ECU power off is detected, the fault mode is released.
Remarks	

● **Presumed cause of the failure or the error condition**

1. Poor connection of connector
2. Wiring failure of the wire-harness
 - SCV (+) output and SCV (-) output wirings are shorted
3. SCV failure caused by a coil short circuit
4. ECU internal circuit failure

P0627: SCV (MPROP) disconnection

P code	P0627	Name	SCV (MPROP) disconnection
SPN/FMI	633/5		

● DTC detection criteria

1. Prerequisite, 2. Judgment criteria	Check points
1. No prerequisite. 2. The high pressure pump drive circuit detects the open circuit.	Connector Wire-harness SCV (MPROP) ECU

● Actions when an error occurs

Fault mode	[Limited operation]: The engine operation is limited.
Limited operation	Yes: <ul style="list-style-type: none"> • When sensor error occurs, rated output of the engine is reduced immediately. • The maximum engine torque is limited to 85%. • The engine speed is limited to the [maximum torque speed +200 min⁻¹]. • EGR fully closes. • DPF regeneration stops. • Rated output of the engine is reduced further after 15 min. • The maximum engine torque is limited to 50%. • The engine speed is limited to the [maximum torque speed +200 min⁻¹].
Reset criteria	Yes: When the ECU power off is detected, the fault mode is released.
Remarks	

● Presumed cause of the failure or the error condition

1. Poor connection of connector
2. Wiring failure of the wire-harness
 - SCV (MPROP) open circuit
3. SCV (MPROP) failure by the open circuit
4. ECU internal circuit failure

P025B: SCV (MPROP) failure diagnosis information not received

P code	P025B	Name	SCV (MPROP) failure diagnosis information not received
SPN/FMI	633/11		

● **DTC detection criteria**

1. Prerequisite, 2. Judgment criteria	Check points
1. No prerequisite. 2. The state in which the microcomputer cannot receive diagnostic information from the high-pressure pump drive circuit continues for a specified period of time.	ECU

● **Actions when an error occurs**

Fault mode	[Continuous operation]: The engine continues to operate without limitations after the error is detected.
Limited operation	No
Reset criteria	Yes: When the ECU power off is detected, the fault mode is released.
Remarks	

● **Presumed cause of the failure or the error condition**

1. ECU internal circuit failure

● **Diagnosis**

1. Initial diagnosis using SA-D	<ul style="list-style-type: none"> • Check the fault indication. • Turn off the ECU power and check the fault display again. <p>* See Chapter 2 P447 for details on the diagnosis method and procedure.</p>
---------------------------------	---

P062A: SCV (MPROP) drive current (high level)

P code	P062A	Name	SCV (MPROP) drive current (high level)
SPN/FMI	522572/6		

● DTC detection criteria

1. Prerequisite, 2. Judgment criteria	Check points
1. No prerequisite. 2. The drive current is greater than threshold value.	Connector Wire-harness SCV (MPROP) ECU

● Actions when an error occurs

Fault mode	[Limited operation]: The engine operation is limited.
Limited operation	Yes: <ul style="list-style-type: none"> • When sensor error occurs, rated output of the engine is reduced immediately. • The maximum engine torque is limited to 85%. • The engine speed is limited to the [maximum torque speed +200 min⁻¹]. • EGR fully closes. • DPF regeneration stops. • Rated output of the engine is reduced further after 15 min. • The maximum engine torque is limited to 50%. • The engine speed is limited to the [maximum torque speed +200 min⁻¹].
Reset criteria	Yes: When the ECU power off is detected, the fault mode is released.
Remarks	

● Presumed cause of the failure or the error condition

1. Poor connection of connector
2. Wiring failure of the wire-harness
3. SCV (MPROP) failure
4. ECU internal circuit failure

● Diagnosis

1. Initial diagnosis using SA-D	<ul style="list-style-type: none">• Check the fault indication. <p>* See Chapter 2 P447 for details on the diagnosis method and procedure.</p>
---------------------------------	--

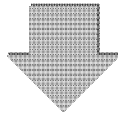

2. Connector/wiring check	<ul style="list-style-type: none">• Before beginning your work, be sure to turn off the ECU power.• Check the pin of the SCV (MPROP) for deformation and cracks, the condition of the connection, and whether the retainer is loose or removed.• Make sure that the SCV (MPROP) wiring is not cut or the wiring coating is not peeled.
---------------------------	--

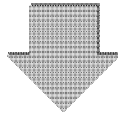

3. Failure diagnosis	<ul style="list-style-type: none">• Check the conduction of the wire-harness.• Check the SCV (MPROP) resistance value. <p>* See Chapter 2 P447 for details on the diagnosis method and procedure.</p>
----------------------	--

P1645: SCV (MPROP) pump overload error

P code	P1645	Name	SCV (MPROP) pump overload error
SPN/FMI	522572/11		

● DTC detection criteria

1. Prerequisite, 2. Judgment criteria	Check points
1. No prerequisite. 2. Abnormal heating in drive circuit is detected.	Connector Wire-harness SCV (MPROP) ECU

● Actions when an error occurs

Fault mode	[Limited operation]: The engine operation is limited.
Limited operation	Yes: <ul style="list-style-type: none"> • When sensor error occurs, rated output of the engine is reduced immediately. • The maximum engine torque is limited to 85%. • The engine speed is limited to the [maximum torque speed +200 min⁻¹]. • EGR fully closes. • DPF regeneration stops. • Rated output of the engine is reduced further after 15 min. • The maximum engine torque is limited to 50%. • The engine speed is limited to the [maximum torque speed +200 min⁻¹].
Reset criteria	Yes: When the ECU power off is detected, the fault mode is released.
Remarks	

● Presumed cause of the failure or the error condition

1. Poor connection of connector
2. Wiring failure of the wire-harness
3. SCV (MPROP) failure
4. ECU internal circuit failure

● Diagnosis

1. Initial diagnosis using SA-D	<ul style="list-style-type: none">• Check the fault indication. <p>* See Chapter 2 P447 for details on the diagnosis method and procedure.</p>
---------------------------------	--

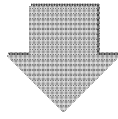

2. Connector/wiring check	<ul style="list-style-type: none">• Before beginning your work, be sure to turn off the ECU power.• Check the pin of the SCV (MPROP) for deformation and cracks, the condition of the connection, and whether the retainer is loose or removed.• Make sure that the SCV (MPROP) wiring is not cut or the wiring coating is not peeled.
---------------------------	--

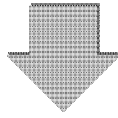

3. Failure diagnosis	<ul style="list-style-type: none">• Check the conduction of the wire-harness.• Check the SCV (MPROP) resistance value. <p>* See Chapter 2 P447 for details on the diagnosis method and procedure.</p>
----------------------	--

■ Rail pressure error

P0088: Rail pressure too high

P code	P0088	Name	Rail pressure too high
SPN/FMI	157/0		

● DTC detection criteria

1. Prerequisite, 2. Judgment criteria	Check points
1. Rail pressure sensor is normal. 2. When the specified time (5 s) is continued with the rail pressure 170 MPa or more.	Fuel system Supply pump Rail pressure sensor

● Actions when an error occurs

Fault mode	[Limited operation]: The engine operation is limited.
Limited operation	Yes: <ul style="list-style-type: none"> • When sensor error occurs, rated output of the engine is reduced immediately. • The maximum engine torque is limited to 85%. • The engine speed is limited to the [maximum torque speed +200 min⁻¹]. • EGR fully closes. • DPF regeneration stops. • Rated output of the engine is reduced further after 15 min. • The maximum engine torque is limited to 50%. • The engine speed is limited to the [maximum torque speed +200 min⁻¹].
Reset criteria	Yes: When the ECU power off is detected, the fault mode is released.
Remarks	

● Presumed cause of the failure or the error condition

1. Rail pressure sensor system failure
2. SCV drive circuit system failure
3. SCV open sticking
4. SCV intermittent failure
5. Fuel system failure
 - Air intrusion
 - Insufficient gas

● Diagnosis

1. Initial diagnosis using SA-D	<ul style="list-style-type: none">• Check the fault indication.
---------------------------------	---

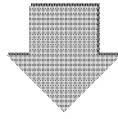

2. Connector/wiring check	<ul style="list-style-type: none">• Before beginning your work, be sure to turn off the ECU power.• Check the pin of the SCV (MPROP) and the rail pressure sensor for deformation and cracks, the condition of the connection, and whether the retainer is loose or removed.• Make sure that the SCV (MPROP) and the rail pressure sensor wiring is not cut or shorted to the power/ground line, or the wiring coating is not peeled.
---------------------------	---

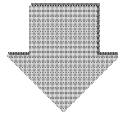

3. Failure diagnosis	<ul style="list-style-type: none">• Check the fuel system, common rail system, and supply pump.• If needed, exchange the parts of the fuel system or common rail system, supply pump. <p>* For details on the check method and procedure, refer to TNV Tier4 CR engine service manual.</p>
----------------------	---

P0094: Rail pressure deviation error (low rail pressure)

P code	P0094	Name	Rail pressure deviation error (low rail pressure)
SPN/FMI	157/18		

● DTC detection criteria

1. Prerequisite, 2. Judgment criteria	Check points
1. Rail pressure sensor is normal. 2. The actual rail pressure is smaller than the target rail pressure and the difference of 20 MPa or more is continued for a given period of time (10 seconds).	Fuel system Supply pump Rail pressure sensor

● Actions when an error occurs

Fault mode	[Limited operation]: The engine operation is limited.
Limited operation	Yes: <ul style="list-style-type: none"> • When sensor error occurs, rated output of the engine is reduced immediately. • The maximum engine torque is limited to 85%. • The engine speed is limited to the [maximum torque speed +200 min⁻¹]. • EGR fully closes. • DPF regeneration stops. • Rated output of the engine is reduced further after 15 min. • The maximum engine torque is limited to 50%. • The engine speed is limited to the [maximum torque speed +200 min⁻¹].
Reset criteria	Yes: When the ECU power off is detected, the fault mode is released.
Remarks	

● Presumed cause of the failure or the error condition

1. Rail pressure sensor system failure
2. SCV drive circuit system failure
3. SCV open sticking
4. SCV closed sticking
5. SCV intermittent failure
6. Fuel system failure
 - Air intrusion
 - Insufficient gas

● Diagnosis

1. Initial diagnosis using SA-D	<ul style="list-style-type: none">• Check the fault indication.
---------------------------------	---

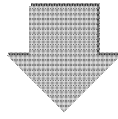

2. Connector/wiring check	<ul style="list-style-type: none">• Before beginning your work, be sure to turn off the ECU power.• Check the pin of the SCV (MPROP) and the rail pressure sensor for deformation and cracks, the condition of the connection, and whether the retainer is loose or removed.• Make sure that the SCV (MPROP) and the rail pressure sensor wiring is not cut or shorted to the power/ground line, or the wiring coating is not peeled.
---------------------------	---

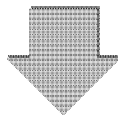

3. Failure diagnosis	<ul style="list-style-type: none">• Check the fuel system, common rail system, and supply pump.• If needed, exchange the parts of the fuel system or common rail system, supply pump. <p>* For details on the check method and procedure, refer to TNV Tier4 CR engine service manual.</p>
----------------------	---

P0093: Rail pressure deviation error (high rail pressure)

P code	P0093	Name	Rail pressure deviation error (high rail pressure)
SPN/FMI	157/15		

● DTC detection criteria

1. Prerequisite, 2. Judgment criteria	Check points
1. Rail pressure sensor is normal. 2. The actual rail pressure is larger than the target rail pressure and the difference of 20 MPa or more is continued for a given period of time (5 s).	Fuel system Supply pump Rail pressure sensor

● Actions when an error occurs

Fault mode	[Limited operation]: The engine operation is limited.
Limited operation	Yes: <ul style="list-style-type: none"> • When sensor error occurs, rated output of the engine is reduced immediately. • The maximum engine torque is limited to 85%. • The engine speed is limited to the [maximum torque speed +200 min⁻¹]. • EGR fully closes. • DPF regeneration stops. • Rated output of the engine is reduced further after 15 min. • The maximum engine torque is limited to 50%. • The engine speed is limited to the [maximum torque speed +200 min⁻¹].
Reset criteria	Yes: When the ECU power off is detected, the fault mode is released.
Remarks	

● Presumed cause of the failure or the error condition

1. Rail pressure sensor system failure
2. SCV drive circuit system failure
3. SCV open sticking
4. SCV intermittent failure
5. Fuel system failure
 - Air intrusion
 - Insufficient gas

● Diagnosis

1. Initial diagnosis using SA-D	<ul style="list-style-type: none">• Check the fault indication.
---------------------------------	---

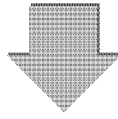

2. Connector/wiring check	<ul style="list-style-type: none">• Before beginning your work, be sure to turn off the ECU power.• Check the pin of the SCV (MPROP) and the rail pressure sensor for deformation and cracks, the condition of the connection, and whether the retainer is loose or removed.• Make sure that the SCV (MPROP) and the rail pressure sensor wiring is not cut or shorted to the power/ground line, or the wiring coating is not peeled.
---------------------------	---

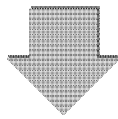

3. Failure diagnosis	<ul style="list-style-type: none">• Check the fuel system, common rail system, and supply pump.• If needed, exchange the parts of the fuel system or common rail system, supply pump. <p>* For details on the check method and procedure, refer to TNV Tier4 CR engine service manual.</p>
----------------------	---

■ PLV (Common rail pressure limit valve)

P000F: PLV open valve

P code	P000F	Name	PLV open valve
SPN/FMI	157/16		

● DTC detection criteria

1. Prerequisite, 2. Judgment criteria	Check points
1. No prerequisite. 2. Common rail pressure limit valve opens.	Fuel system Supply pump

● Actions when an error occurs

Fault mode	[Limited operation]: The engine operation is limited.
Limited operation	Yes: <ul style="list-style-type: none"> • When sensor error occurs, rated output of the engine is reduced immediately. • The maximum engine torque is limited to 85%. • The engine speed is limited to the [maximum torque speed +200 min⁻¹]. • EGR fully closes. • DPF regeneration stops. • Rated output of the engine is reduced further after 15 min. • The maximum engine torque is limited to 50%. • The engine speed is limited to the [maximum torque speed +200 min⁻¹].
Reset criteria	Yes: When the ECU power off is detected, the fault mode is released.
Remarks	

● Presumed cause of the failure or the error condition

1. Rail pressure sensor system failure
2. SCV drive circuit system failure
3. SCV open sticking
4. SCV intermittent failure
5. Fuel system failure
 - Air intrusion
 - Insufficient gas

● Diagnosis

1. Initial diagnosis using SA-D	<ul style="list-style-type: none">• Check the fault indication.
---------------------------------	---

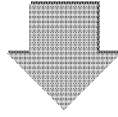

2. Connector/wiring check	<ul style="list-style-type: none">• Before beginning your work, be sure to turn off the ECU power.• Check the pin of the SCV (MPROP) and the rail pressure sensor for deformation and cracks, the condition of the connection, and whether the retainer is loose or removed.• Make sure that the SCV (MPROP) and the rail pressure sensor wiring is not cut or shorted to the power/ground line, or the wiring coating is not peeled.
---------------------------	---

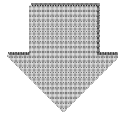

3. Failure diagnosis	<ul style="list-style-type: none">• Check the fuel system, common rail system, and supply pump.• If needed, exchange the parts of the fuel system or common rail system, supply pump. <p>* For details on the check method and procedure, refer to TNV Tier4 CR engine service manual.</p>
----------------------	---

P1666: Rail pressure fault (The times of PLV valve opening error)

P code	P1666	Name	Rail pressure fault (The times of PLV valve opening error)
SPN/FMI	523469/0		

● DTC detection criteria

1. Prerequisite, 2. Judgment criteria	Check points
1. Rail pressure sensor is normal. 2. The opening times of the pressure control valve of common rail exceeds 50.	Fuel system Supply pump Rail pressure sensor ECU

● Actions when an error occurs

Fault mode	[Limited operation]: The engine operation is limited.
Limited operation	Yes: <ul style="list-style-type: none"> • When sensor error occurs, rated output of the engine is reduced immediately. • The maximum engine torque is limited to 85%. • The engine speed is limited to the [maximum torque speed +200 min⁻¹]. • EGR fully closes. • DPF regeneration stops. • Rated output of the engine is reduced further after 15 min. • The maximum engine torque is limited to 50%. • The engine speed is limited to the [maximum torque speed +200 min⁻¹].
Reset criteria	Yes: When the ECU power off is detected, the fault mode is released.
Remarks	

● Presumed cause of the failure or the error condition

1. Rail pressure sensor system failure
2. SCV drive circuit system failure
3. SCV open sticking
4. SCV intermittent failure
5. Fuel system failure
 - Air intrusion
 - Insufficient gas

● Diagnosis

1. Initial diagnosis using SA-D	<ul style="list-style-type: none">• Check the fault indication.
---------------------------------	---

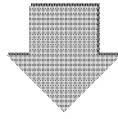

2. Connector/wiring check	<ul style="list-style-type: none">• Before beginning your work, be sure to turn off the ECU power.• Check the pin of the SCV (MPROP) and the rail pressure sensor for deformation and cracks, the condition of the connection, and whether the retainer is loose or removed.• Make sure that the SCV (MPROP) and the rail pressure sensor wiring is not cut or shorted to the power/ground line, or the wiring coating is not peeled.
---------------------------	---

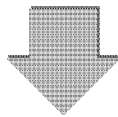

3. Failure diagnosis	<ul style="list-style-type: none">• Check the fuel system, common rail system, and supply pump. Exchange the PLV.• If needed, exchange the parts of the fuel system or common rail system, supply pump. <p>* For details on the check method and procedure, refer to TNV Tier4 CR engine service manual.</p>
----------------------	---

P1667: Rail pressure fault (The time of PLV valve opening error)

P code	P1667	Name	Rail pressure fault (The time of PLV valve opening error)
SPN/FMI	523470/0		

● DTC detection criteria

1. Prerequisite, 2. Judgment criteria	Check points
1. Rail pressure sensor is normal. 2. The cumulative opening time of the pressure control valve of common rail exceeds 5 hours.	Fuel system Supply pump Rail pressure sensor ECU

● Actions when an error occurs

Fault mode	[Limited operation]: The engine operation is limited.
Limited operation	Yes: <ul style="list-style-type: none"> • When sensor error occurs, rated output of the engine is reduced immediately. • The maximum engine torque is limited to 85%. • The engine speed is limited to the [maximum torque speed +200 min⁻¹]. • EGR fully closes. • DPF regeneration stops. • Rated output of the engine is reduced further after 15 min. • The maximum engine torque is limited to 50%. • The engine speed is limited to the [maximum torque speed +200 min⁻¹].
Reset criteria	Yes: When the ECU power off is detected, the fault mode is released.
Remarks	

● Presumed cause of the failure or the error condition

1. Rail pressure sensor system failure
2. SCV drive circuit system failure
3. SCV open sticking
4. SCV intermittent failure
5. Fuel system failure
 - Air intrusion
 - Insufficient gas

● Diagnosis

1. Initial diagnosis using SA-D	<ul style="list-style-type: none">• Check the fault indication.
---------------------------------	---

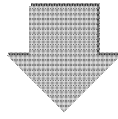

2. Connector/wiring check	<ul style="list-style-type: none">• Before beginning your work, be sure to turn off the ECU power.• Check the pin of the SCV (MPROP) and the rail pressure sensor for deformation and cracks, the condition of the connection, and whether the retainer is loose or removed.• Make sure that the SCV (MPROP) and the rail pressure sensor wiring is not cut or shorted to the power/ground line, or the wiring coating is not peeled.
---------------------------	---

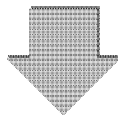

3. Failure diagnosis	<ul style="list-style-type: none">• Check the fuel system, common rail system, and supply pump. Exchange the PLV.• If needed, exchange the parts of the fuel system or common rail system, supply pump. <p>* For details on the check method and procedure, refer to TNV Tier4 CR engine service manual.</p>
----------------------	---

P1668: Rail pressure fault (The actual rail pressure is too high during PRV limp home)

P code	P1668	Name	Rail pressure fault (The actual rail pressure is too high during PRV limp home)
SPN/FMI	523489/0		

● DTC detection criteria

1. Prerequisite, 2. Judgment criteria	Check points
1. Rail pressure sensor is normal. 2. The pressure control valve of common rail fails to open when abnormally high pressure of common rail occurred (rail pressure of 160 MPa or higher continues for 10 seconds or longer).	Fuel system Supply pump Rail pressure sensor

● Actions when an error occurs

Fault mode	[Engine stop]: The engine operation stops.
Limited operation	Yes: Fuel injection stops.
Reset criteria	Yes: When the ECU power off is detected, the fault mode is released.
Remarks	

● Presumed cause of the failure or the error condition

1. Rail pressure sensor system failure
2. SCV drive circuit system failure
3. SCV open sticking
4. SCV intermittent failure
5. Fuel system failure
 - Air intrusion
 - Insufficient gas

● Diagnosis

1. Initial diagnosis using SA-D	<ul style="list-style-type: none">• Check the fault indication.
---------------------------------	---

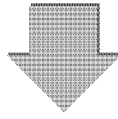

2. Connector/wiring check	<ul style="list-style-type: none">• Before beginning your work, be sure to turn off the ECU power.• Check the pin of the SCV (MPROP) and the rail pressure sensor for deformation and cracks, the condition of the connection, and whether the retainer is loose or removed.• Make sure that the SCV (MPROP) and the rail pressure sensor wiring is not cut or shorted to the power/ground line, or the wiring coating is not peeled.
---------------------------	---

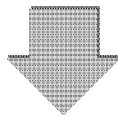

3. Failure diagnosis	<ul style="list-style-type: none">• Check the fuel system, common rail system, and supply pump.• If needed, exchange the parts of the fuel system or common rail system, supply pump. <p>* For details on the check method and procedure, refer to TNV Tier4 CR engine service manual.</p>
----------------------	---

P1665: Rail pressure fault (Controlled rail pressure error after PLV valve opening)

P code	P1665	Name	Rail pressure fault (Controlled rail pressure error after PLV valve opening)
SPN/FMI	523468/9		

● DTC detection criteria

1. Prerequisite, 2. Judgment criteria	Check points
1. Rail pressure sensor is normal. 2. Rail pressure deviates from the range from 50 to 120 MPa after common rail pressure control valve is opened.	Fuel system Supply pump Rail pressure sensor

● Actions when an error occurs

Fault mode	[Engine stop]: The engine operation stops.
Limited operation	Yes: Fuel injection stops.
Reset criteria	Yes: When the ECU power off is detected, the fault mode is released.
Remarks	

● Presumed cause of the failure or the error condition

1. Rail pressure sensor system failure
2. SCV drive circuit system failure
3. SCV open sticking
4. SCV intermittent failure
5. Fuel system failure
 - Air intrusion
 - Insufficient gas

● Diagnosis

1. Initial diagnosis using SA-D	<ul style="list-style-type: none">• Check the fault indication.
---------------------------------	---

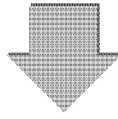

2. Connector/wiring check	<ul style="list-style-type: none">• Before beginning your work, be sure to turn off the ECU power.• Check the pin of the SCV (MPROP) and the rail pressure sensor for deformation and cracks, the condition of the connection, and whether the retainer is loose or removed.• Make sure that the SCV (MPROP) and the rail pressure sensor wiring is not cut or shorted to the power/ground line, or the wiring coating is not peeled.
---------------------------	---

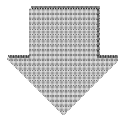

3. Failure diagnosis	<ul style="list-style-type: none">• Check the fuel system, common rail system, and supply pump.• If needed, exchange the parts of the fuel system or common rail system, supply pump. <p>* For details on the check method and procedure, refer to TNV Tier4 CR engine service manual.</p>
----------------------	---

■ Rail pressure control

P1669: Rail pressure fault (Injector B/F temperature error during PLV4 limp home)

P code	P1669	Name	Rail pressure fault (Injector B/F temperature error during PLV4 limp home)
SPN/FMI	523491/0		

● DTC detection criteria

1. Prerequisite, 2. Judgment criteria	Check points
1. Rail pressure sensor is normal. 2. The fuel temperature exceeds 80 °C after common rail pressure control valve is opened.	Fuel system Supply pump Rail pressure sensor

● Actions when an error occurs

Fault mode	[Limited operation]: The engine operation is limited.
Limited operation	Yes: <ul style="list-style-type: none"> • When sensor error occurs, rated output of the engine is reduced immediately. • The maximum engine torque is limited to 85%. • The engine speed is limited to the [maximum torque speed +200 min⁻¹]. • EGR fully closes. • DPF regeneration stops. • Rated output of the engine is reduced further after 15 min. • The maximum engine torque is limited to 50%. • The engine speed is limited to the [maximum torque speed +200 min⁻¹].
Reset criteria	Yes: When the ECU power off is detected, the fault mode is released.
Remarks	

● Presumed cause of the failure or the error condition

1. Rail pressure sensor system failure
2. SCV drive circuit system failure
3. SCV open sticking
4. SCV intermittent failure
5. Fuel system failure
 - Air intrusion
 - Insufficient gas

● Diagnosis

1. Initial diagnosis using SA-D	<ul style="list-style-type: none">• Check the fault indication.
---------------------------------	---

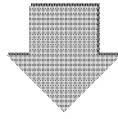

2. Connector/wiring check	<ul style="list-style-type: none">• Before beginning your work, be sure to turn off the ECU power.• Check the pin of the SCV (MPROP) and the rail pressure sensor for deformation and cracks, the condition of the connection, and whether the retainer is loose or removed.• Make sure that the SCV (MPROP) and the rail pressure sensor wiring is not cut or shorted to the power/ground line, or the wiring coating is not peeled.
---------------------------	---

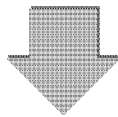

3. Failure diagnosis	<ul style="list-style-type: none">• Check the fuel system, common rail system, and supply pump.• If needed, exchange the parts of the fuel system or common rail system, supply pump. <p>* For details on the check method and procedure, refer to TNV Tier4 CR engine service manual.</p>
----------------------	---

P1670: Rail pressure fault (Operation time error during RPS limp home)

P code	P1670	Name	Rail pressure fault (Operation time error during RPS limp home)
SPN/FMI	523460/7		

● DTC detection criteria

1. Prerequisite, 2. Judgment criteria	Check points
1. Rail pressure sensor is normal. 2. Either of the following is true: <ul style="list-style-type: none"> • The rail pressure sensor and the high-pressure pump drive circuit (MPROP) are abnormal • The rail pressure sensor and the fuel temperature sensor are abnormal 	Connector Wire-harness SCV (MPROP) Fuel temperature sensor ECU

● Actions when an error occurs

Fault mode	[Engine stop]: The engine operation stops.
Limited operation	Yes: Fuel injection stops.
Reset criteria	Yes: When the ECU power off is detected, the fault mode is released.
Remarks	

● Presumed cause of the failure or the error condition

1. Rail pressure sensor failure or that wiring failure
2. SCV failure or that wiring failure
3. Fuel temperature sensor failure or that wiring failure

● Diagnosis

- Refer to “Rail pressure sensor error (voltage low) or (voltage high)”
- Refer to “SCV(MPROP) fault”
- Refer to “Fuel temperature sensor error (voltage low) or (voltage high)”

Actuator

■ Intake throttle drive circuit

P0660: No-load of throttle valve drive H bridge circuit

P code	P0660	Name	No-load of throttle valve drive H bridge circuit
SPN/FMI	2950/5		

● DTC detection criteria

1. Prerequisite, 2. Judgment criteria	Check points
1. No prerequisite. 2. No-load (open circuit) of drive circuit is detected.	Connector Wire-harness Intake throttle ECU

● Actions when an error occurs

Fault mode	[Limited operation]: The engine operation is limited.
Limited operation	Yes: • When sensor error occurs, rated output of the engine is reduced immediately. • The maximum engine torque is limited to 85%. • EGR fully closes. • Intake throttle fully opens. • DPF regeneration stops. • Rated output of the engine is reduced further after 120 min. • The maximum engine torque is limited to 50%.
Reset criteria	Yes: When the ECU power is turned off, the fault mode is released.
Remarks	

● Presumed cause of the failure or the error condition

1. Poor connection of connector
2. Wiring failure of the wire-harness
 - High side disconnection of the intake throttle drive circuit
 - Low side disconnection of the intake throttle drive circuit
3. Intake throttle failure due to disconnection
4. ECU internal circuit failure

P1658: Power short circuit of throttle valve drive H bridge output 1

P code	P1658	Name	Power short circuit of throttle valve drive H bridge output 1
SPN/FMI	2950/3		

● DTC detection criteria

1. Prerequisite, 2. Judgment criteria	Check points
1. No prerequisite. 2. Output terminal 1 of drive circuit is VB short circuit.	Connector Wire-harness Intake throttle ECU

● Actions when an error occurs

Fault mode	[Limited operation]: The engine operation is limited.
Limited operation	Yes: <ul style="list-style-type: none"> • When sensor error occurs, rated output of the engine is reduced immediately. • The maximum engine torque is limited to 85%. • EGR fully closes. • Intake throttle fully opens. • DPF regeneration stops. • Rated output of the engine is reduced further after 120 min. • The maximum engine torque is limited to 50%.
Reset criteria	Yes: When the ECU power is turned off, the fault mode is released.
Remarks	

● Presumed cause of the failure or the error condition

1. Poor connection of connector
2. Wiring failure of the wire-harness
 - High side power short circuit of the intake throttle drive circuit
3. Intake throttle failure due to power short circuit
4. ECU internal circuit failure

P1659: GND short circuit of throttle valve drive H bridge output 1

P code	P1659	Name	GND short circuit of throttle valve drive H bridge output 1
SPN/FMI	2950/4		

● **DTC detection criteria**

1. Prerequisite, 2. Judgment criteria	Check points
1. No prerequisite. 2. Output terminal 1 of drive circuit is GND short circuit.	Connector Wire-harness Intake throttle ECU

● **Actions when an error occurs**

Fault mode	[Limited operation]: The engine operation is limited.
Limited operation	Yes: <ul style="list-style-type: none"> • When sensor error occurs, rated output of the engine is reduced immediately. • The maximum engine torque is limited to 85%. • EGR fully closes. • Intake throttle fully opens. • DPF regeneration stops. • Rated output of the engine is reduced further after 120 min. • The maximum engine torque is limited to 50%.
Reset criteria	Yes: When the ECU power is turned off, the fault mode is released.
Remarks	

● **Presumed cause of the failure or the error condition**

1. Poor connection of connector
2. Wiring failure of the wire-harness
 - High side GND short circuit of the intake throttle drive circuit
3. Intake throttle failure due to GND short circuit
4. ECU internal circuit failure

P1660: Overload on the drive H bridge circuit of throttle valve

P code	P1660	Name	Overload on the drive H bridge circuit of throttle valve
SPN/FMI	2950/6		

● DTC detection criteria

1. Prerequisite, 2. Judgment criteria	Check points
1. No prerequisite. 2. The component temperature of the drive circuit exceeds the threshold value.	Connector Wire-harness Intake throttle ECU

● Actions when an error occurs

Fault mode	[Limited operation]: The engine operation is limited.
Limited operation	Yes: <ul style="list-style-type: none"> • When sensor error occurs, rated output of the engine is reduced immediately. • The maximum engine torque is limited to 85%. • EGR fully closes. • Intake throttle fully opens. • DPF regeneration stops. • Rated output of the engine is reduced further after 120 min. • The maximum engine torque is limited to 50%.
Reset criteria	Yes: When the ECU power off is detected, the fault mode is released.
Remarks	

● Presumed cause of the failure or the error condition

1. Insulation failure of the connector
2. Wiring failure of the wire-harness
 - High side short circuit of the intake throttle drive circuit
 - Low side short circuit of the intake throttle drive circuit
3. Intake throttle failure due to short circuit
4. ECU internal circuit failure

P1661: VB Power short circuit of throttle valve drive H bridge output 2

P code	P1661	Name	VB Power short circuit of throttle valve drive H bridge output 2
SPN/FMI	2951/3		

● **DTC detection criteria**

1. Prerequisite, 2. Judgment criteria	Check points
1. No prerequisite. 2. Output terminal 2 of drive circuit is VB short circuit.	Connector Wire-harness Intake throttle ECU

● **Actions when an error occurs**

Fault mode	[Limited operation]: The engine operation is limited.
Limited operation	Yes: <ul style="list-style-type: none"> • When sensor error occurs, rated output of the engine is reduced immediately. • The maximum engine torque is limited to 85%. • EGR fully closes. • Intake throttle fully opens. • DPF regeneration stops. • Rated output of the engine is reduced further after 120 min. • The maximum engine torque is limited to 50%.
Reset criteria	Yes: When the ECU power is turned off, the fault mode is released.
Remarks	

● **Presumed cause of the failure or the error condition**

1. Poor connection of connector
2. Wiring failure of the wire-harness
 - Low side power short circuit of the intake throttle drive circuit
3. Intake throttle failure due to power short circuit
4. ECU internal circuit failure

P1662: GND short circuit of throttle valve drive H bridge output 2

P code	P1662	Name	GND short circuit of throttle valve drive H bridge output 2
SPN/FMI	2951/4		

● DTC detection criteria

1. Prerequisite, 2. Judgment criteria	Check points
1. No prerequisite. 2. Output terminal 2 of drive circuit is GND short circuit.	Connector Wire-harness Intake throttle ECU

● Actions when an error occurs

Fault mode	[Limited operation]: The engine operation is limited.
Limited operation	Yes: <ul style="list-style-type: none"> • When sensor error occurs, rated output of the engine is reduced immediately. • The maximum engine torque is limited to 85%. • EGR fully closes. • Intake throttle fully opens. • DPF regeneration stops. • Rated output of the engine is reduced further after 120 min. • The maximum engine torque is limited to 50%.
Reset criteria	Yes: When the ECU power is turned off, the fault mode is released.
Remarks	

● Presumed cause of the failure or the error condition

1. Poor connection of connector
2. Wiring failure of the wire-harness
 - Low side GND short circuit of the intake throttle drive circuit
3. Intake throttle failure due to GND short circuit
4. ECU internal circuit failure

P02E4: Throttle valve sticking (sticking open)

P code	P02E4	Name	Throttle valve sticking (sticking open)
SPN/FMI	2950/7		

● **DTC detection criteria**

1. Prerequisite, 2. Judgment criteria	Check points
1. No prerequisite. 2. When the actual degree of opening of the throttle valve is 50% or less, if the difference between the target opening and the actual opening is $\pm 10\%$ or more for 1 second or more, this difference cannot be eliminated even if operation to release valve sticking is continued for the prescribed number of times. <ul style="list-style-type: none"> • 12 V: 10 times \times 8 • 24 V: 7 times \times 6 	Connector Wire-harness Intake throttle ECU

● **Actions when an error occurs**

Fault mode	[Limited operation]: The engine operation is limited.
Limited operation	Yes: <ul style="list-style-type: none"> • When sensor error occurs, rated output of the engine is reduced immediately. • The maximum engine torque is limited to 85%. • The engine speed is limited to the [maximum torque speed +200 min⁻¹]. • EGR fully closes. • Intake throttle fully opens. • DPF regeneration stops. • Rated output of the engine is reduced further after 15 min. • The maximum engine torque is limited to 50%. • The engine speed is limited to the [maximum torque speed +200 min⁻¹].
Reset criteria	Yes: When the ECU power is turned off, the fault mode is released.
Remarks	

● **Presumed cause of the failure or the error condition**

1. Intake throttle sticking
2. Poor connection of connector
3. Wiring failure of the wire-harness
4. Internal circuit of intake throttle failure

● Diagnosis

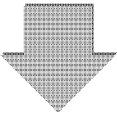
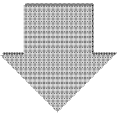
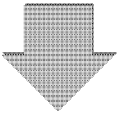
1. Initial diagnosis using SA-D	<ul style="list-style-type: none">• Check the fault indication. <p>* See Chapter 2 P453 for details on the diagnosis method and procedure.</p>
	
2. Engine check	<ul style="list-style-type: none">• Before beginning your work, be sure to turn off the key switch, and turn off the ECU power.• Check the intake throttle condition.
	
3. Connector/wiring check	<ul style="list-style-type: none">• Check the pin of the intake throttle for deformation and cracks, the condition of the connection, and whether the retainer is loose or removed.• Make sure that the intake throttle wiring is not disconnected or the wiring coating is not peeled.
	
4. Failure diagnosis	<ul style="list-style-type: none">• Check the intake throttle (motor) resistance value.• Check the ECU output voltage.• Check the intake throttle position sensor output voltage.• Check the conduction of the wire-harness. <p>* See Chapter 2 P453 for details on the diagnosis method and procedure.</p>

P02E5: Throttle valve sticking (sticking closed)

P code	P02E5	Name	Throttle valve sticking (sticking closed)
SPN/FMI	2951/7		

● **DTC detection criteria**

1. Prerequisite, 2. Judgment criteria	Check points
1. No prerequisite. 2. With the actual degree of opening at 50% or less, if the difference between the target opening and the actual opening is $\pm 10\%$ or more for 1 second or more, the difference cannot be eliminated even if operation (six sets \times 7 repetitions) to release valve sticking is continued for the prescribed number of times. <ul style="list-style-type: none"> • 12 V: 10 times \times 8 • 24 V: 7 times \times 6 	Connector Wire-harness Intake throttle ECU

● **Actions when an error occurs**

Fault mode	[Limited operation]: The engine operation is limited.
Limited operation	Yes: <ul style="list-style-type: none"> • When sensor error occurs, rated output of the engine is reduced immediately. • The maximum engine torque is limited to 85%. • The engine speed is limited to the [maximum torque speed +200 min⁻¹]. • EGR fully closes. • Intake throttle fully opens. • DPF regeneration stops. • Rated output of the engine is reduced further after 15 min. • The maximum engine torque is limited to 50%. • The engine speed is limited to the [maximum torque speed +200 min⁻¹].
Reset criteria	Yes: When the ECU power is turned off, the fault mode is released.
Remarks	

● **Presumed cause of the failure or the error condition**

1. Intake throttle sticking
2. Poor connection of connector
3. Wiring failure of the wire-harness
4. Internal circuit of intake throttle failure

● Diagnosis

1. Initial diagnosis using SA-D	<ul style="list-style-type: none">• Check the fault indication. <p>* See Chapter 2 P453 for details on the diagnosis method and procedure.</p>
---------------------------------	--

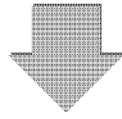

2. Engine check	<ul style="list-style-type: none">• Before beginning your work, be sure to turn off the key switch, and turn off the ECU power.• Check the intake throttle condition.
-----------------	--

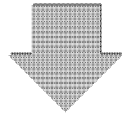

3. Connector/wiring check	<ul style="list-style-type: none">• Check the pin of the intake throttle for deformation and cracks, the condition of the connection, and whether the retainer is loose or removed.• Make sure that the intake throttle wiring is not disconnected or the wiring coating is not peeled.
---------------------------	--

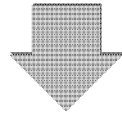

4. Failure diagnosis	<ul style="list-style-type: none">• Check the intake throttle (motor) resistance value.• Check the ECU output voltage.• Check the intake throttle position sensor output voltage.• Check the conduction of the wire-harness. <p>* See Chapter 2 P453 for details on the diagnosis method and procedure.</p>
----------------------	--

■ EGR

P0404: EGR overvoltage error

P code	P0404	Name	EGR overvoltage error
SPN/FMI	2791/0		

● DTC detection criteria

1. Prerequisite, 2. Judgment criteria	Check points
1. Communication between ECU and EGR valve is normal. 2. Supply voltage to EGR valve is more than 18 V for more than 5 seconds.	Battery EGR valve

● Actions when an error occurs

Fault mode	[Limited operation]: The engine operation is limited.
Limited operation	Yes: <ul style="list-style-type: none"> • When sensor error occurs, rated output of the engine is reduced immediately. • The maximum engine torque is limited to 85%. • EGR fully closes. • Rated output of the engine is reduced further after 120 min. • The maximum engine torque is limited to 50%. • Simultaneous to the above operating restrictions, engine operation restrictions are applied according to the inducement level of the EGR system abnormality. The level of restriction applied will whichever level is higher. <ul style="list-style-type: none"> a. Warning When engine operation time is less than 36 hours since abnormality occurred. In this case, restrictions on engine speed/fuel injection quantity vary depending on the error. b. Inducement (Low level) When engine operation time 36 hours or more and less than 100 hours from error occurrences (or less than 5 hours (*1)), Inducement level becomes Low level. In this case, the torque is limited to 75%. (For some errors, the engine speed is restricted to low idle and the maximum fuel injection quantity is restricted to 50%.) c. Inducement (Severe level) When engine operation time is 100 hours or more from error occurrences (or 5 hours or more (*1)), Inducement level becomes Severe level. In this case, the engine speed is restricted to 60% of its rated speed (in some engine models), and the torque is restricted to 50%. (For some errors, the engine speed is restricted to low idle and the maximum fuel injection quantity is restricted to 50%.) <p>(*1) This time indicates a case when another abnormality that results in inducement occurs within 40 hours of recovery from a previous abnormality.</p>
Reset criteria	Yes: When the ECU power is turned off, the fault mode is released.
Remarks	

● Presumed cause of the failure or the error condition

1. Battery overcharging
2. Failure of EGR valve internal circuit

● Diagnosis

1. Initial diagnosis using SA-D	• Check the fault indication.
------------------------------------	-------------------------------

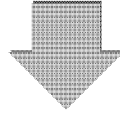

2. Failure diagnosis	• Check the conduction of the wire-harness. • Check the battery voltage.
----------------------	---

P1404: EGR low voltage error

P code	P1404	Name	EGR low voltage error
SPN/FMI	2791/1		

● DTC detection criteria

1. Prerequisite, 2. Judgment criteria	Check points
1. Abnormality is determined by EGR reception data. 2. Supply voltage to EGR valve is less than 8 V for more than 13 seconds.	Wire-harness Battery EGR valve

● Actions when an error occurs

Fault mode	[Limited operation]: The engine operation is limited.
Limited operation	Yes: <ul style="list-style-type: none"> • When sensor error occurs, rated output of the engine is reduced immediately. • The maximum engine torque is limited to 85%. • EGR fully closes. • Rated output of the engine is reduced further after 120 min. • The maximum engine torque is limited to 50%. • Simultaneous to the above operating restrictions, engine operation restrictions are applied according to the inducement level of the EGR system abnormality. The level of restriction applied will whichever level is higher. <ul style="list-style-type: none"> a. Warning <ul style="list-style-type: none"> When engine operation time is less than 36 hours since abnormality occurred. In this case, restrictions on engine speed/fuel injection quantity vary depending on the error. b. Inducement (Low level) <ul style="list-style-type: none"> When engine operation time 36 hours or more and less than 100 hours from error occurrences (or less than 5 hours (*1)), Inducement level becomes Low level. In this case, the torque is limited to 75%. (For some errors, the engine speed is restricted to low idle and the maximum fuel injection quantity is restricted to 50%.) c. Inducement (Severe level) <ul style="list-style-type: none"> When engine operation time is 100 hours or more from error occurrences (or 5 hours or more (*1)), Inducement level becomes Severe level. In this case, the engine speed is restricted to 60% of its rated speed (in some engine models), and the torque is restricted to 50%. (For some errors, the engine speed is restricted to low idle and the maximum fuel injection quantity is restricted to 50%.) (*1) This time indicates a case when another abnormality that results in inducement occurs within 40 hours of recovery from a previous abnormality.
Reset criteria	Yes: When the ECU power is turned off, the fault mode is released.
Remarks	

● Presumed cause of the failure or the error condition

1. Battery degradation
2. Power wire short circuit of the EGR valve
3. Failure of EGR valve internal circuit

● Diagnosis

1. Initial diagnosis using SA-D	<ul style="list-style-type: none">• Check the fault indication.
---------------------------------	---

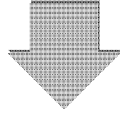

2. Failure diagnosis	<ul style="list-style-type: none">• Check the conduction of the wire-harness.• Check the battery voltage.
----------------------	--

P1409: EGR feedback error

P code	P1409	Name	EGR feedback error
SPN/FMI	2791/7		

● **DTC detection criteria**

1. Prerequisite, 2. Judgment criteria	Check points
1. Communication between ECU and EGR valve is normal. 2. Motor drive duty at the excessive condition is continued for 3 seconds.	EGR valve

● **Actions when an error occurs**

Fault mode	[Limited operation]: The engine operation is limited.
Limited operation	Yes: <ul style="list-style-type: none"> • When sensor error occurs, rated output of the engine is reduced immediately. • The maximum engine torque is limited to 85%. • EGR fully closes. • Rated output of the engine is reduced further after 120 min. • The maximum engine torque is limited to 50%. • Simultaneous to the above operating restrictions, engine operation restrictions are applied according to the inducement level of the EGR system abnormality. The level of restriction applied will whichever level is higher. <ul style="list-style-type: none"> a. Warning When engine operation time is less than 36 hours since abnormality occurred. In this case, restrictions on engine speed/fuel injection quantity vary depending on the error. b. Inducement (Low level) When engine operation time 36 hours or more and less than 100 hours from error occurrences (or less than 5 hours (*1)), Inducement level becomes Low level. In this case, the torque is limited to 75%. (For some errors, the engine speed is restricted to low idle and the maximum fuel injection quantity is restricted to 50%.) c. Inducement (Severe level) When engine operation time is 100 hours or more from error occurrences (or 5 hours or more (*1)), Inducement level becomes Severe level. In this case, the engine speed is restricted to 60% of its rated speed (in some engine models), and the torque is restricted to 50%. (For some errors, the engine speed is restricted to low idle and the maximum fuel injection quantity is restricted to 50%.) (*1) This time indicates a case when another abnormality that results in inducement occurs within 40 hours of recovery from a previous abnormality.
Reset criteria	Yes: When the ECU power is turned off, the fault mode is released.
Remarks	

● **Presumed cause of the failure or the error condition**

1. Failure of EGR valve internal circuit

● **Diagnosis**

1. Initial diagnosis using SA-D	<ul style="list-style-type: none"> • Check the fault indication. • Switch the ECU power from ON to OFF to check the fault indication again. • If this DTC is detected again, exchange the EGR valve. <p>* For details on the exchange method and procedure, refer to TNV Tier4 CR engine service manual.</p>
---------------------------------	---

U0401: EGR ECM data error

P code	U0401	Name	EGR ECM data error
SPN/FMI	2791/9		

● DTC detection criteria

1. Prerequisite, 2. Judgment criteria	Check points
1. No prerequisite. 2. Instruction packet cut-off from ECU to EGR valve continues for one second.	Wire-harness EGR valve

● Actions when an error occurs

Fault mode	[Limited operation]: The engine operation is limited.
Limited operation	<p>Yes: • When sensor error occurs, rated output of the engine is reduced immediately.</p> <ul style="list-style-type: none"> • The maximum engine torque is limited to 85%. • EGR fully closes. • Rated output of the engine is reduced further after 120 min. • The maximum engine torque is limited to 50%. • Simultaneous to the above operating restrictions, engine operation restrictions are applied according to the inducement level of the EGR system abnormality. The level of restriction applied will whichever level is higher. <ul style="list-style-type: none"> a. Warning When engine operation time is less than 36 hours since abnormality occurred. In this case, restrictions on engine speed/fuel injection quantity vary depending on the error. b. Inducement (Low level) When engine operation time 36 hours or more and less than 100 hours from error occurrences (or less than 5 hours (*1)), Inducement level becomes Low level. In this case, the torque is limited to 75%. (For some errors, the engine speed is restricted to low idle and the maximum fuel injection quantity is restricted to 50%.) c. Inducement (Severe level) When engine operation time is 100 hours or more from error occurrences (or 5 hours or more (*1)), Inducement level becomes Severe level. In this case, the engine speed is restricted to 60% of its rated speed (in some engine models), and the torque is restricted to 50%. (For some errors, the engine speed is restricted to low idle and the maximum fuel injection quantity is restricted to 50%.) <p>(*1) This time indicates a case when another abnormality that results in inducement occurs within 40 hours of recovery from a previous abnormality.</p>
Reset criteria	Yes: When the ECU power is turned off, the fault mode is released.
Remarks	Because this error is detected in the EGR valve and fault information is sent to the ECU, the indication timing of the information is when the communication is resumed. Therefore, this DTC is not outputted while the communication is stopped, but the receiving time of U010B: CAN1 (for EGR): Reception time out is detected separately.

● Presumed cause of the failure or the error condition

1. Poor connection of connector
2. Wiring failure of the wire-harness
3. Failure of EGR valve internal circuit

● Diagnosis

1. Initial diagnosis using SA-D	<ul style="list-style-type: none">• Check the fault indication.
---------------------------------	---

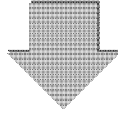

2. Connector/wiring check	<ul style="list-style-type: none">• Before beginning your work, be sure to turn off the ECU power.• Check the pin of the EGR valve for deformation and cracks, the condition of the connection, and whether the retainer is loose or removed.• Make sure that the EGR valve or EGR valve relay wiring is not cut or the wiring coating is not peeled.
---------------------------	---

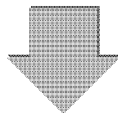

3. Failure diagnosis	<ul style="list-style-type: none">• Check the fault indication again.• If this DTC is detected again, exchange the wire-harness or EGR valve.
----------------------	--

P0403: Disconnection in EGR motor coils

P code	P0403	Name	Disconnection in EGR motor coils
SPN/FMI	2791/12		

● **DTC detection criteria**

1. Prerequisite, 2. Judgment criteria	Check points
1. Communication between ECU and EGR valve is normal. 2. Disconnection of motor coil inside the EGR valve or disconnection of drive circuit is detected.	EGR valve

● **Actions when an error occurs**

Fault mode	[Limited operation]: The engine operation is limited.
Limited operation	Yes: <ul style="list-style-type: none"> • When sensor error occurs, rated output of the engine is reduced immediately. • The maximum engine torque is limited to 85%. • EGR fully closes. • Rated output of the engine is reduced further after 120 min. • The maximum engine torque is limited to 50%. • Simultaneous to the above operating restrictions, engine operation restrictions are applied according to the inducement level of the EGR system abnormality. The level of restriction applied will whichever level is higher. <ul style="list-style-type: none"> a. Warning When engine operation time is less than 36 hours since abnormality occurred. In this case, restrictions on engine speed/fuel injection quantity vary depending on the error. b. Inducement (Low level) When engine operation time 36 hours or more and less than 100 hours from error occurrences (or less than 5 hours (*1)), Inducement level becomes Low level. In this case, the torque is limited to 75%. (For some errors, the engine speed is restricted to low idle and the maximum fuel injection quantity is restricted to 50%.) c. Inducement (Severe level) When engine operation time is 100 hours or more from error occurrences (or 5 hours or more (*1)), Inducement level becomes Severe level. In this case, the engine speed is restricted to 60% of its rated speed (in some engine models), and the torque is restricted to 50%. (For some errors, the engine speed is restricted to low idle and the maximum fuel injection quantity is restricted to 50%.) (*1) This time indicates a case when another abnormality that results in inducement occurs within 40 hours of recovery from a previous abnormality.
Reset criteria	Yes: When the ECU power is turned off, the fault mode is released.
Remarks	

● **Presumed cause of the failure or the error condition**

1. Failure of EGR valve DC motor

● **Diagnosis**

1. Initial diagnosis using SA-D	<ul style="list-style-type: none"> • Check the fault indication. • Switch the ECU power from ON to OFF to check the fault indication again. • If this DTC is detected again, exchange the EGR valve. <p>* For details on the exchange method and procedure, refer to TNV Tier4 CR engine service manual.</p>
---------------------------------	---

P1405: Short circuit in EGR motor coils

P code	P1405	Name	Short circuit in EGR motor coils
SPN/FMI	522579/12		

● **DTC detection criteria**

1. Prerequisite, 2. Judgment criteria	Check points
1. Communication between ECU and EGR valve is normal. 2. Short circuit of motor coil inside the EGR valve or short circuit of drive circuit is detected.	EGR valve

● **Actions when an error occurs**

Fault mode	[Limited operation]: The engine operation is limited.
Limited operation	Yes: • When sensor error occurs, rated output of the engine is reduced immediately. <ul style="list-style-type: none"> • The maximum engine torque is limited to 85%. • EGR fully closes. • Rated output of the engine is reduced further after 120 min. • The maximum engine torque is limited to 50%. • Simultaneous to the above operating restrictions, engine operation restrictions are applied according to the inducement level of the EGR system abnormality. The level of restriction applied will whichever level is higher. <ul style="list-style-type: none"> a. Warning When engine operation time is less than 36 hours since abnormality occurred. In this case, restrictions on engine speed/fuel injection quantity vary depending on the error. b. Inducement (Low level) When engine operation time 36 hours or more and less than 100 hours from error occurrences (or less than 5 hours (*1)), Inducement level becomes Low level. In this case, the torque is limited to 75%. (For some errors, the engine speed is restricted to low idle and the maximum fuel injection quantity is restricted to 50%.) c. Inducement (Severe level) When engine operation time is 100 hours or more from error occurrences (or 5 hours or more (*1)), Inducement level becomes Severe level. In this case, the engine speed is restricted to 60% of its rated speed (in some engine models), and the torque is restricted to 50%. (For some errors, the engine speed is restricted to low idle and the maximum fuel injection quantity is restricted to 50%.) <p>(*1) This time indicates a case when another abnormality that results in inducement occurs within 40 hours of recovery from a previous abnormality.</p>
Reset criteria	Yes: When the ECU power is turned off, the fault mode is released.
Remarks	

● **Presumed cause of the failure or the error condition**

1. Failure of EGR valve DC motor

● **Diagnosis**

1. Initial diagnosis using SA-D	<ul style="list-style-type: none"> • Check the fault indication. • Switch the ECU power from ON to OFF to check the fault indication again. • If this DTC is detected again, exchange the EGR valve. <p>* For details on the exchange method and procedure, refer to TNV Tier4 CR engine service manual.</p>
---------------------------------	---

P0488: EGR position sensor error

P code	P0488	Name	EGR position sensor error
SPN/FMI	522580/12		

● DTC detection criteria

1. Prerequisite, 2. Judgment criteria	Check points
1. Communication between ECU and EGR valve is normal. 2. Excessive or dropped position sensor signal voltage inside the EGR valve is detected.	EGR valve

● Actions when an error occurs

Fault mode	[Limited operation]: The engine operation is limited.
Limited operation	<p>Yes:</p> <ul style="list-style-type: none"> • When sensor error occurs, rated output of the engine is reduced immediately. • The maximum engine torque is limited to 85%. • EGR fully closes. • Rated output of the engine is reduced further after 120 min. • The maximum engine torque is limited to 50%. • Simultaneous to the above operating restrictions, engine operation restrictions are applied according to the inducement level of the EGR system abnormality. The level of restriction applied will whichever level is higher. <ul style="list-style-type: none"> a. Warning When engine operation time is less than 36 hours since abnormality occurred. In this case, restrictions on engine speed/fuel injection quantity vary depending on the error. b. Inducement (Low level) When engine operation time 36 hours or more and less than 100 hours from error occurrences (or less than 5 hours (*1)), Inducement level becomes Low level. In this case, the torque is limited to 75%. (For some errors, the engine speed is restricted to low idle and the maximum fuel injection quantity is restricted to 50%.) c. Inducement (Severe level) When engine operation time is 100 hours or more from error occurrences (or 5 hours or more (*1)), Inducement level becomes Severe level. In this case, the engine speed is restricted to 60% of its rated speed (in some engine models), and the torque is restricted to 50%. (For some errors, the engine speed is restricted to low idle and the maximum fuel injection quantity is restricted to 50%.) <p>(*1) This time indicates a case when another abnormality that results in inducement occurs within 40 hours of recovery from a previous abnormality.</p>
Reset criteria	Yes: When the ECU power is turned off, the fault mode is released.
Remarks	

● Presumed cause of the failure or the error condition

1. Failure of EGR valve internal circuit

● Diagnosis

1. Initial diagnosis using SA-D	<ul style="list-style-type: none"> • Check the fault indication. • Switch the ECU power from ON to OFF to check the fault indication again. • If this DTC is detected again, exchange the EGR valve. <p>* For details on the exchange method and procedure, refer to TNV Tier4 CR engine service manual.</p>
---------------------------------	---

P148A: EGR valve sticking error

P code	P148A	Name	EGR valve sticking error
SPN/FMI	522581/7		

● **DTC detection criteria**

1. Prerequisite, 2. Judgment criteria	Check points
1. Communication between ECU and EGR valve is normal. 2. The number of steps from the position of motor stopper to the starting point of valve opening is fault (45 steps or more).	EGR valve

● **Actions when an error occurs**

Fault mode	[Limited operation]: The engine operation is limited.
Limited operation	Yes: <ul style="list-style-type: none"> • When sensor error occurs, rated output of the engine is reduced immediately. • The maximum engine torque is limited to 85%. • The engine speed is limited to the [maximum torque speed +200 min⁻¹]. • EGR fully closes. • Rated output of the engine is reduced further after 15 min. • The maximum engine torque is limited to 50%. • The engine speed is limited to the [maximum torque speed +200 min⁻¹]. • Simultaneous to the above operating restrictions, engine operation restrictions are applied according to the inducement level of the EGR system abnormality. The level of restriction applied will whichever level is higher. <ul style="list-style-type: none"> a. Warning <ul style="list-style-type: none"> When engine operation time is less than 36 hours since abnormality occurred. In this case, restrictions on engine speed/fuel injection quantity vary depending on the error. b. Inducement (Low level) <ul style="list-style-type: none"> When engine operation time 36 hours or more and less than 100 hours from error occurrences (or less than 5 hours (*1)), Inducement level becomes Low level. In this case, the torque is limited to 75%. (For some errors, the engine speed is restricted to low idle and the maximum fuel injection quantity is restricted to 50%.) c. Inducement (Severe level) <ul style="list-style-type: none"> When engine operation time is 100 hours or more from error occurrences (or 5 hours or more (*1)), Inducement level becomes Severe level. In this case, the engine speed is restricted to 60% of its rated speed (in some engine models), and the torque is restricted to 50%. (For some errors, the engine speed is restricted to low idle and the maximum fuel injection quantity is restricted to 50%.) (*1) This time indicates a case when another abnormality that results in inducement occurs within 40 hours of recovery from a previous abnormality.
Reset criteria	Yes: When the ECU power is turned off, the fault mode is released.
Remarks	

● **Presumed cause of the failure or the error condition**

1. EGR valve sticking

● **Diagnosis**

1. Initial diagnosis using SA-D	<ul style="list-style-type: none"> • Check the fault indication. • Switch the ECU power from ON to OFF to check the fault indication again. • If this DTC is detected again, inspect and replace the EGR valve. <p>* For details on inspection and replacement, refer to TNV Tier4 CR engine service manual.</p>
---------------------------------	---

P049D: EGR initialization error

P code	P049D	Name	EGR initialization error
SPN/FMI	522582/7		

● **DTC detection criteria**

1. Prerequisite, 2. Judgment criteria	Check points
1. Communication between ECU and EGR valve is normal. 2. The completion time of initialization for EGR valve exceeds the specified range.	EGR valve

● **Actions when an error occurs**

Fault mode	[Limited operation]: The engine operation is limited.
Limited operation	Yes: <ul style="list-style-type: none"> • When sensor error occurs, rated output of the engine is reduced immediately. • The maximum engine torque is limited to 85%. • The engine speed is limited to the [maximum torque speed +200 min⁻¹]. • EGR fully closes. • Rated output of the engine is reduced further after 15 min. • The maximum engine torque is limited to 50%. • The engine speed is limited to the [maximum torque speed +200 min⁻¹]. • Simultaneous to the above operating restrictions, engine operation restrictions are applied according to the inducement level of the EGR system abnormality. The level of restriction applied will whichever level is higher. <ul style="list-style-type: none"> a. Warning <ul style="list-style-type: none"> When engine operation time is less than 36 hours since abnormality occurred. In this case, restrictions on engine speed/fuel injection quantity vary depending on the error. b. Inducement (Low level) <ul style="list-style-type: none"> When engine operation time 36 hours or more and less than 100 hours from error occurrences (or less than 5 hours (*1)), Inducement level becomes Low level. In this case, the torque is limited to 75%. (For some errors, the engine speed is restricted to low idle and the maximum fuel injection quantity is restricted to 50%.) c. Inducement (Severe level) <ul style="list-style-type: none"> When engine operation time is 100 hours or more from error occurrences (or 5 hours or more (*1)), Inducement level becomes Severe level. In this case, the engine speed is restricted to 60% of its rated speed (in some engine models), and the torque is restricted to 50%. (For some errors, the engine speed is restricted to low idle and the maximum fuel injection quantity is restricted to 50%.) (*1) This time indicates a case when another abnormality that results in inducement occurs within 40 hours of recovery from a previous abnormality.
Reset criteria	Yes: When the ECU power is turned off, the fault mode is released.
Remarks	

● **Presumed cause of the failure or the error condition**

1. Failure of EGR valve internal circuit
2. EGR valve failure
3. EGR valve sticking

● **Diagnosis**

1. Initial diagnosis using SA-D	<ul style="list-style-type: none"> • Check the fault indication. • Switch the ECU power from ON to OFF to check the fault indication again. • If this DTC is detected again, exchange the EGR valve. <p>* For details on the exchange method and procedure, refer to TNV Tier4 CR engine service manual.</p>
---------------------------------	---

U1401: EGR target value out of range

P code	U1401	Name	EGR target value out of range
SPN/FMI	522617/12		

● **DTC detection criteria**

1. Prerequisite, 2. Judgment criteria	Check points
1. Communication between ECU and EGR valve is normal. 2. The direction opening from ECU is out of range for a given period of time.	EGR valve ECU

● **Actions when an error occurs**

Fault mode	[Limited operation]: The engine operation is limited.
Limited operation	Yes: • When sensor error occurs, rated output of the engine is reduced immediately. <ul style="list-style-type: none"> • The maximum engine torque is limited to 85%. • EGR fully closes. • Rated output of the engine is reduced further after 120 min. • The maximum engine torque is limited to 50%. • Simultaneous to the above operating restrictions, engine operation restrictions are applied according to the inducement level of the EGR system abnormality. The level of restriction applied will whichever level is higher. <ul style="list-style-type: none"> a. Warning When engine operation time is less than 36 hours since abnormality occurred. In this case, restrictions on engine speed/fuel injection quantity vary depending on the error. b. Inducement (Low level) When engine operation time 36 hours or more and less than 100 hours from error occurrences (or less than 5 hours (*1)), Inducement level becomes Low level. In this case, the torque is limited to 75%. (For some errors, the engine speed is restricted to low idle and the maximum fuel injection quantity is restricted to 50%.) c. Inducement (Severe level) When engine operation time is 100 hours or more from error occurrences (or 5 hours or more (*1)), Inducement level becomes Severe level. In this case, the engine speed is restricted to 60% of its rated speed (in some engine models), and the torque is restricted to 50%. (For some errors, the engine speed is restricted to low idle and the maximum fuel injection quantity is restricted to 50%.) <p>(*1) This time indicates a case when another abnormality that results in inducement occurs within 40 hours of recovery from a previous abnormality.</p>
Reset criteria	Yes: When the ECU power is turned off, the fault mode is released.
Remarks	

● **Presumed cause of the failure or the error condition**

1. ECU software error

● **Diagnosis**

1. Initial diagnosis using SA-D	<ul style="list-style-type: none"> • Check the fault indication. • Switch the ECU power from ON to OFF to check the fault indication again. • If this DTC is detected again, exchange the EGR valve.
---------------------------------	---

P1410: EGR high temperature thermistor error

P code	P1410	Name	EGR high temperature thermistor error
SPN/FMI	522583/1		

● **DTC detection criteria**

1. Prerequisite, 2. Judgment criteria	Check points
1. Communication between ECU and EGR valve is normal. 2. The high temperature side thermistor inside the control unit of the EGR valve is 0.2 V or below.	EGR valve

● **Actions when an error occurs**

Fault mode	[Limited operation]: The engine operation is limited.
Limited operation	Yes: <ul style="list-style-type: none"> • When sensor error occurs, rated output of the engine is reduced immediately. • The maximum engine torque is limited to 85%. • EGR fully closes. • Rated output of the engine is reduced further after 120 min. • The maximum engine torque is limited to 50%. • Simultaneous to the above operating restrictions, engine operation restrictions are applied according to the inducement level of the EGR system abnormality. The level of restriction applied will whichever level is higher. <ul style="list-style-type: none"> a. Warning When engine operation time is less than 36 hours since abnormality occurred. In this case, restrictions on engine speed/fuel injection quantity vary depending on the error. b. Inducement (Low level) When engine operation time 36 hours or more and less than 100 hours from error occurrences (or less than 5 hours (*1)), Inducement level becomes Low level. In this case, the torque is limited to 75%. (For some errors, the engine speed is restricted to low idle and the maximum fuel injection quantity is restricted to 50%.) c. Inducement (Severe level) When engine operation time is 100 hours or more from error occurrences (or 5 hours or more (*1)), Inducement level becomes Severe level. In this case, the engine speed is restricted to 60% of its rated speed (in some engine models), and the torque is restricted to 50%. (For some errors, the engine speed is restricted to low idle and the maximum fuel injection quantity is restricted to 50%.) (*1) This time indicates a case when another abnormality that results in inducement occurs within 40 hours of recovery from a previous abnormality.
Reset criteria	Yes: When the ECU power is turned off, the fault mode is released.
Remarks	

● **Presumed cause of the failure or the error condition**

1. Failure of EGR valve internal circuit

● **Diagnosis**

1. Initial diagnosis using SA-D	<ul style="list-style-type: none"> • Check the fault indication. • Switch the ECU power from ON to OFF to check the fault indication again. • If this DTC is detected again, exchange the EGR valve. <p>* For details on the exchange method and procedure, refer to TNV Tier4 CR engine service manual.</p>
---------------------------------	---

P1411: EGR low temperature thermistor error

P code	P1411	Name	EGR low temperature thermistor error
SPN/FMI	522584/1		

● **DTC detection criteria**

1. Prerequisite, 2. Judgment criteria	Check points
1. Communication between ECU and EGR valve is normal. 2. The low temperature side thermistor inside the control unit of the EGR valve is 0.2 V or below.	EGR valve

● **Actions when an error occurs**

Fault mode	[Limited operation]: The engine operation is limited.
Limited operation	Yes: <ul style="list-style-type: none"> • When sensor error occurs, rated output of the engine is reduced immediately. • The maximum engine torque is limited to 85%. • EGR fully closes. • Rated output of the engine is reduced further after 120 min. • The maximum engine torque is limited to 50%. • Simultaneous to the above operating restrictions, engine operation restrictions are applied according to the inducement level of the EGR system abnormality. The level of restriction applied will whichever level is higher. <ul style="list-style-type: none"> a. Warning When engine operation time is less than 36 hours since abnormality occurred. In this case, restrictions on engine speed/fuel injection quantity vary depending on the error. b. Inducement (Low level) When engine operation time 36 hours or more and less than 100 hours from error occurrences (or less than 5 hours (*1)), Inducement level becomes Low level. In this case, the torque is limited to 75%. (For some errors, the engine speed is restricted to low idle and the maximum fuel injection quantity is restricted to 50%.) c. Inducement (Severe level) When engine operation time is 100 hours or more from error occurrences (or 5 hours or more (*1)), Inducement level becomes Severe level. In this case, the engine speed is restricted to 60% of its rated speed (in some engine models), and the torque is restricted to 50%. (For some errors, the engine speed is restricted to low idle and the maximum fuel injection quantity is restricted to 50%.) (*1) This time indicates a case when another abnormality that results in inducement occurs within 40 hours of recovery from a previous abnormality.
Reset criteria	Yes: When the ECU power is turned off, the fault mode is released.
Remarks	

● **Presumed cause of the failure or the error condition**

1. Failure of EGR valve internal circuit

● **Diagnosis**

1. Initial diagnosis using SA-D	<ul style="list-style-type: none"> • Check the fault indication. • Switch the ECU power from ON to OFF to check the fault indication again. • If this DTC is detected again, exchange the EGR valve. <p>* For details on the exchange method and procedure, refer to TNV Tier4 CR engine service manual.</p>
---------------------------------	---

■ Exhaust throttle

P1438: Exhaust throttle (voltage fault)

P code	P1438	Name	Exhaust throttle (voltage fault)
SPN/FMI	522746/12		

● DTC detection criteria

1. Prerequisite, 2. Judgment criteria	Check points
1. No prerequisite. 2. When the power supply voltage detected by the exhaust throttle becomes either of the following: <ul style="list-style-type: none"> • The situation that the detected voltage is less than or equal to 6 V continues for 10 seconds • The situation that the detected voltage is greater than or equal to 16 V continues for 1 second 	Battery Exhaust throttle

● Actions when an error occurs

Fault mode	[Limited operation]: The engine operation is limited.
Limited operation	Yes: <ul style="list-style-type: none"> • When sensor error occurs, rated output of the engine is reduced immediately. • The maximum engine torque is limited to 85%. • Exhaust throttle fully opens.
Reset criteria	Yes: When the ECU power is turned off, the fault mode is released.
Remarks	

● Presumed cause of the failure or the error condition

1. Battery failure
2. Failure of exhaust throttle internal circuit

● Diagnosis

1. Initial diagnosis using SA-D	<ul style="list-style-type: none"> • Check the fault indication.
---------------------------------	---

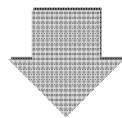

2. Failure diagnosis	<ul style="list-style-type: none"> • Check the conduction of the wire-harness. • Check the battery voltage.
----------------------	---

P1439: Exhaust throttle (motor fault)

P code	P1439	Name	Exhaust throttle (motor fault)
SPN/FMI	522747/12		

● **DTC detection criteria**

1. Prerequisite, 2. Judgment criteria	Check points
1. No prerequisite. 2. When any of the following is true inside the exhaust throttle: <ul style="list-style-type: none"> • Motor drive duty at the excessive condition is continued for a period of time • Learning value exceeds normal range • Overcurrent, overload, open circuit, or short circuit of the motor coil is detected 	Exhaust throttle

● **Actions when an error occurs**

Fault mode	[Engine stop]: The engine operation stops.
Limited operation	Yes: Fuel injection stops.
Reset criteria	Yes: When the ECU power is turned off, the fault mode is released.
Remarks	

● **Presumed cause of the failure or the error condition**

1. DC motor failure of exhaust throttle
2. Failure of exhaust throttle internal circuit
3. Sticking of exhaust throttle valve

● **Diagnosis**

1. Initial diagnosis using SA-D	<ul style="list-style-type: none"> • Check the fault indication. • Switch the ECU power from ON to OFF to check the fault indication again. • If this DTC is detected again, inspect and replace the exhaust throttle. <p>* For details on inspection and replacement, refer to TNV Tier4 CR engine service manual.</p>
---------------------------------	--

P1440: Exhaust throttle (sensor system fault)

P code	P1440	Name	Exhaust throttle (sensor system fault)
SPN/FMI	522748/12		

● DTC detection criteria

1. Prerequisite, 2. Judgment criteria	Check points
1. No prerequisite. 2. When any of the following is true in the exhaust throttle: <ul style="list-style-type: none"> • Excessive or insufficient sensor supply voltage is detected • Excessive or insufficient voltage of location signal sensor is detected • State where the target opening and the actual opening does not match continues for a certain period 	Exhaust throttle

● Actions when an error occurs

Fault mode	[Engine stop]: The engine operation stops.
Limited operation	Yes: Fuel injection stops.
Reset criteria	Yes: When the ECU power is turned off, the fault mode is released.
Remarks	

● Presumed cause of the failure or the error condition

1. Failure of exhaust throttle internal circuit
2. Sticking of exhaust throttle valve

● Diagnosis

1. Initial diagnosis using SA-D	<ul style="list-style-type: none"> • Check the fault indication. • Switch the ECU power from ON to OFF to check the fault indication again. • If this DTC is detected again, inspect and replace the exhaust throttle. <p>* For details on inspection and replacement, refer to TNV Tier4 CR engine service manual.</p>
---------------------------------	--

P1441: Exhaust throttle (MPU fault)

P code	P1441	Name	Exhaust throttle (MPU fault)
SPN/FMI	522749/12		

● **DTC detection criteria**

1. Prerequisite, 2. Judgment criteria	Check points
1. No prerequisite. 2. MPU inside the exhaust throttle is fault.	Exhaust throttle

● **Actions when an error occurs**

Fault mode	[Limited operation]: The engine operation is limited.
Limited operation	Yes: • When sensor error occurs, rated output of the engine is reduced immediately. • The maximum engine torque is limited to 85%. • Exhaust throttle fully opens.
Reset criteria	Yes: When the ECU power is turned off, the fault mode is released.
Remarks	

● **Presumed cause of the failure or the error condition**

1. Failure of exhaust throttle internal circuit

● **Diagnosis**

1. Initial diagnosis using SA-D	<ul style="list-style-type: none"> • Check the fault indication. • Switch the ECU power from ON to OFF to check the fault indication again. • If this DTC is detected again, inspect and replace the exhaust throttle. <p>* For details on inspection and replacement, refer to TNV Tier4 CR engine service manual.</p>
---------------------------------	--

P1442: Exhaust throttle (PCB fault)

P code	P1442	Name	Exhaust throttle (PCB fault)
SPN/FMI	522750/12		

● DTC detection criteria

1. Prerequisite, 2. Judgment criteria	Check points
1. No prerequisite. 2. Excessive or insufficient voltage of temperature thermistor inside the exhaust throttle is detected.	Exhaust throttle

● Actions when an error occurs

Fault mode	[Continuous operation]: The engine continues to operate without limitations after the error is detected.
Limited operation	No
Reset criteria	Yes: When the ECU power is turned off, the fault mode is released.
Remarks	

● Presumed cause of the failure or the error condition

1. Failure of exhaust throttle internal circuit

● Diagnosis

1. Initial diagnosis using SA-D	<ul style="list-style-type: none"> • Check the fault indication. • Switch the ECU power from ON to OFF to check the fault indication again. • If this DTC is detected again, inspect and replace the exhaust throttle. <p>* For details on inspection and replacement, refer to TNV Tier4 CR engine service manual.</p>
---------------------------------	--

P1443: Exhaust throttle (CAN fault)

P code	P1443	Name	Exhaust throttle (CAN fault)
SPN/FMI	522751/19		

● **DTC detection criteria**

1. Prerequisite, 2. Judgment criteria	Check points
1. No prerequisite. 2. When any of the following is true: <ul style="list-style-type: none"> • CAN communication controller of the exhaust throttle detects initial error • Exhaust throttle detects CAN reception time-out for a period of time 	ECU Connector Wire-harness Exhaust throttle

● **Actions when an error occurs**

Fault mode	[Limited operation]: The engine operation is limited.
Limited operation	Yes: <ul style="list-style-type: none"> • When sensor error occurs, rated output of the engine is reduced immediately. • The maximum engine torque is limited to 85%. • Exhaust throttle fully opens.
Reset criteria	Yes: When the ECU power is turned off, the fault mode is released.
Remarks	Because this error is detected in the exhaust throttle and information is sent to the ECU, the timing of the error indication is the time when the communication is resumed. Therefore, this DTC is not outputted while the communication is stopped, but the receiving timeout of U1107: CAN 1 (for exhaust throttle) determined on the ECU side is detected separately.

● **Presumed cause of the failure or the error condition**

1. Poor connection of connector
2. Poor wiring of the wire-harness
3. Failure of exhaust throttle internal circuit
4. ECU software error

● **Diagnosis**

1. Initial diagnosis using SA-D	<ul style="list-style-type: none"> • Check the fault indication.
---------------------------------	---

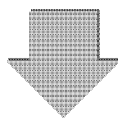

2. Connector/wiring check	<ul style="list-style-type: none"> • Before beginning your work, be sure to turn off the ECU power. • Check the pin of the exhaust throttle for deformation and cracks, fittings, and whether the retainer is loose or removed. • Make sure that the exhaust throttle wiring is not cut or the wiring coating is not peeled.
---------------------------	---

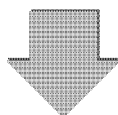

3. Failure diagnosis	<ul style="list-style-type: none"> • Check the fault indication again. • If this DTC is detected again, exchange the wire-harness or exhaust throttle.
----------------------	--

Communication related

■ CAN 1

U010B: CAN 1 (for EGR): Reception time out

P code	U010B	Name	CAN 1 (for EGR): Reception time out
SPN/FMI	522610/9		

● DTC detection criteria

1. Prerequisite, 2. Judgment criteria	Check points
1. The following conditions are all true: <ul style="list-style-type: none"> • Key switch is ON • Not in cranking status • Battery voltage is 10 V or higher 2. A reception time out is detected at a fixed time.	ECU Connector Wire-harness EGR valve EGR valve relay

● Actions when an error occurs

Fault mode	[Limited operation]: The engine operation is limited.
Limited operation	Yes: <ul style="list-style-type: none"> • When sensor error occurs, rated output of the engine is reduced immediately. <ul style="list-style-type: none"> • The maximum engine torque is limited to 85%. • EGR fully closes. • Rated output of the engine is reduced further after 120 min. • The maximum engine torque is limited to 50%. • Simultaneous to the above operating restrictions, engine operation restrictions are applied according to the inducement level of the EGR system abnormality. The level of restriction applied will whichever level is higher. <ul style="list-style-type: none"> a. Warning <ul style="list-style-type: none"> When engine operation time is less than 36 hours since abnormality occurred. In this case, restrictions on engine speed/fuel injection quantity vary depending on the error. b. Inducement (Low level) <ul style="list-style-type: none"> When engine operation time 36 hours or more and less than 100 hours from error occurrences (or less than 5 hours (*1)), Inducement level becomes Low level. In this case, the torque is limited to 75%. (For some errors, the engine speed is restricted to low idle and the maximum fuel injection quantity is restricted to 50%.) c. Inducement (Severe level) <ul style="list-style-type: none"> When engine operation time is 100 hours or more from error occurrences (or 5 hours or more (*1)), Inducement level becomes Severe level. In this case, the engine speed is restricted to 60% of its rated speed (in some engine models), and the torque is restricted to 50%. (For some errors, the engine speed is restricted to low idle and the maximum fuel injection quantity is restricted to 50%.) (*1) This time indicates a case when another abnormality that results in inducement occurs within 40 hours of recovery from a previous abnormality.
Reset criteria	Yes: When the CAN message from the EGR valve is received, the fault mode is automatically released.
Remarks	

● **Presumed cause of the failure or the error condition**

1. Poor connection of connector
2. Wire-harness disconnection/short circuit
3. ECU internal circuit failure
4. EGR valve internal circuit failure
5. EGR valve relay failure

U1107: CAN 1 (for exhaust throttle): Reception time out

P code	U1107	Name	CAN 1 (for exhaust throttle): Reception time out
SPN/FMI	522611/9		

● DTC detection criteria

1. Prerequisite, 2. Judgment criteria	Check points
1. When any of the following is true: <ul style="list-style-type: none"> • Key switch is ON • Not in cranking status • Battery voltage is 10 V or higher 2. A reception time out is eased at a fixed time.	ECU Connector Wire-harness Exhaust throttle EGR valve relay

● Actions when an error occurs

Fault mode	[Limited operation]: The engine operation is limited.
Limited operation	Yes: <ul style="list-style-type: none"> • When sensor error occurs, rated output of the engine is reduced immediately. • The maximum engine torque is limited to 85%. • Exhaust throttle fully opens.
Reset criteria	Yes: When the ECU power is turned off, the fault mode is released.
Remarks	

● Presumed cause of the failure or the error condition

1. Poor connection of connector
2. Wire-harness disconnection/short circuit
3. ECU internal circuit failure
4. Failure of exhaust throttle internal circuit
5. EGR valve relay failure

■ CAN 2

U0292: TSC1 (SA1) reception timeout

P code	U0292	Name	TSC1 (SA1) reception timeout
SPN/FMI	522596/9		

● DTC detection criteria

1. Prerequisite, 2. Judgment criteria	Check points
1. The following conditions are all true: <ul style="list-style-type: none"> • Key switch is ON • Not in cranking status • Battery voltage is 10 V or higher 2. A reception time out is detected at a fixed time.	Connector Wire-harness Controller of machine side ECU

● Actions when an error occurs

Fault mode	[Continuous operation]: Engine control is not obstructed.
Limited operation	No
Reset criteria	Yes: The following operation can be selected by setting application. <ul style="list-style-type: none"> • When the ECU power is turned off, the fault mode is released. • The fault mode is automatically reset when TSC1 message is received.
Remarks	

● Presumed cause of the failure or the error condition

1. CAN communication error from the controller on the driven machine
2. Poor connection of connector
3. Wire-harness disconnection/short circuit
4. ECU internal circuit failure

● Diagnosis

1. Initial diagnosis using SA-D	<ul style="list-style-type: none">• Check the fault indication. <p>* See Chapter 2 P467 for details on the diagnosis method and procedure.</p>
---------------------------------	--

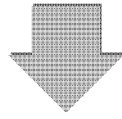

2. Connector/wiring check	<ul style="list-style-type: none">• Before beginning your work, be sure to turn off the ECU power.• Check the pin of the CAN communication connector for deformation and cracks, the condition of the connection, and whether the retainer is loose or removed.• Make sure that the CAN communication connector wiring is not cut or the wiring coating is not peeled.
---------------------------	--

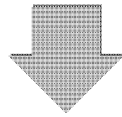

3. Failure diagnosis	<ul style="list-style-type: none">• Check the conduction of the wire-harness. <p>* See Chapter 2 P467 for details on the diagnosis method and procedure.</p>
----------------------	--

U1301: TSC1 (SA2) reception timeout

P code	U1301	Name	TSC1 (SA2) reception timeout
SPN/FMI	522597/9		

● **DTC detection criteria**

1. Prerequisite, 2. Judgment criteria	Check points
1. The following conditions are all true: <ul style="list-style-type: none"> • Key switch is ON • Not in cranking status • Battery voltage is 10 V or higher 2. A reception time out is detected at a fixed time.	Connector Wire-harness Controller of machine side ECU

● **Actions when an error occurs**

Fault mode	[Continuous operation]: Engine control is not obstructed.
Limited operation	No
Reset criteria	Yes: When the ECU power off is detected, the fault mode is released.
Remarks	

● **Presumed cause of the failure or the error condition**

1. CAN communication error from the controller on the driven machine
2. Poor connection of connector
3. Wire-harness disconnection/short circuit
4. ECU internal circuit failure

● Diagnosis

1. Initial diagnosis using SA-D	<ul style="list-style-type: none">• Check the fault indication. <p>* See Chapter 2 P467 for details on the diagnosis method and procedure.</p>
---------------------------------	--

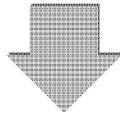

2. Connector/wiring check	<ul style="list-style-type: none">• Before beginning your work, be sure to turn off the ECU power.• Check the pin of the CAN communication connector for deformation and cracks, the condition of the connection, and whether the retainer is loose or removed.• Make sure that the CAN communication connector wiring is not cut or the wiring coating is not peeled.
---------------------------	--

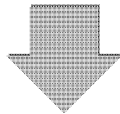

3. Failure diagnosis	<ul style="list-style-type: none">• Check the conduction of the wire-harness. <p>* See Chapter 2 P467 for details on the diagnosis method and procedure.</p>
----------------------	--

U1292: Y_ECR1 reception timeout

P code	U1292	Name	Y_ECR1 reception timeout
SPN/FMI	522599/9		

● **DTC detection criteria**

1. Prerequisite, 2. Judgment criteria	Check points
1. The following conditions are all true: <ul style="list-style-type: none"> • Key switch is ON • Not in cranking status • Battery voltage is 10 V or higher 2. A reception time out is detected at a fixed time.	Connector Wire-harness Controller of machine side ECU

● **Actions when an error occurs**

Fault mode	[Continuous operation]: Engine control is not obstructed.
Limited operation	No
Reset criteria	Yes: The following operation can be selected by setting application. <ul style="list-style-type: none"> • When the ECU power is turned off, the fault mode is released. • The fault mode is automatically reset when Y_ECR1 message is received.
Remarks	

● **Presumed cause of the failure or the error condition**

1. CAN communication error from the controller on the driven machine
2. Poor connection of connector
3. Wire-harness disconnection/short circuit
4. ECU internal circuit failure

● Diagnosis

1. Initial diagnosis using SA-D	<ul style="list-style-type: none">• Check the fault indication. <p>* See Chapter 2 P467 for details on the diagnosis method and procedure.</p>
---------------------------------	--

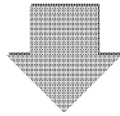

2. Connector/wiring check	<ul style="list-style-type: none">• Before beginning your work, be sure to turn off the ECU power.• Check the pin of the CAN communication connector for deformation and cracks, the condition of the connection, and whether the retainer is loose or removed.• Make sure that the CAN communication connector wiring is not cut or the wiring coating is not peeled.
---------------------------	--

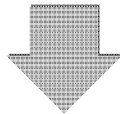

3. Failure diagnosis	<ul style="list-style-type: none">• Check the conduction of the wire-harness. <p>* See Chapter 2 P467 for details on the diagnosis method and procedure.</p>
----------------------	--

U1293: Y_EC reception timeout

P code	U1293	Name	Y_EC reception timeout
SPN/FMI	522600/9		

● **DTC detection criteria**

1. Prerequisite, 2. Judgment criteria	Check points
1. The following conditions are all true: <ul style="list-style-type: none"> • Key switch is ON • Not in cranking status • Battery voltage is 10 V or higher 2. A reception time out is detected at a fixed time.	Connector Wire-harness Controller of machine side ECU

● **Actions when an error occurs**

Fault mode	[Continuous operation]: Engine control is not obstructed.
Limited operation	No
Reset criteria	Yes: The following operation can be selected by setting application. <ul style="list-style-type: none"> • When the ECU power is turned off, the fault mode is released. • The fault mode is automatically reset when Y_EC message is received.
Remarks	

● **Presumed cause of the failure or the error condition**

1. CAN communication error from the controller on the driven machine
2. Poor connection of connector
3. Wire-harness disconnection/short circuit
4. ECU internal circuit failure

● Diagnosis

1. Initial diagnosis using SA-D	<ul style="list-style-type: none">• Check the fault indication. <p>* See Chapter 2 P467 for details on the diagnosis method and procedure.</p>
---------------------------------	--

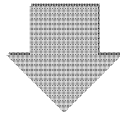

2. Connector/wiring check	<ul style="list-style-type: none">• Before beginning your work, be sure to turn off the ECU power.• Check the pin of the CAN communication connector for deformation and cracks, the condition of the connection, and whether the retainer is loose or removed.• Make sure that the CAN communication connector wiring is not cut or the wiring coating is not peeled.
---------------------------	--

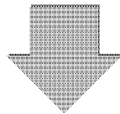

3. Failure diagnosis	<ul style="list-style-type: none">• Check the conduction of the wire-harness. <p>* See Chapter 2 P467 for details on the diagnosis method and procedure.</p>
----------------------	--

U1294: Y_RSS reception timeout

P code	U1294	Name	Y_RSS reception timeout
SPN/FMI	522601/9		

● **DTC detection criteria**

1. Prerequisite, 2. Judgment criteria	Check points
1. The following conditions are all true: <ul style="list-style-type: none"> • Key switch is ON • Not in cranking status • Battery voltage is 10 V or higher 2. A reception time out is detected at a fixed time.	Connector Wire-harness Controller of machine side ECU

● **Actions when an error occurs**

Fault mode	[Continuous operation]: Engine control is not obstructed.
Limited operation	No
Reset criteria	Yes: The following operation can be selected by setting application. <ul style="list-style-type: none"> • When the ECU power is turned off, the fault mode is released. • The fault mode is automatically reset when Y_RSS message is received.
Remarks	

● **Presumed cause of the failure or the error condition**

1. CAN communication error from the controller on the driven machine
2. Poor connection of connector
3. Wire-harness disconnection/short circuit
4. ECU internal circuit failure

● Diagnosis

1. Initial diagnosis using SA-D	<ul style="list-style-type: none">• Check the fault indication. <p>* See Chapter 2 P467 for details on the diagnosis method and procedure.</p>
---------------------------------	--

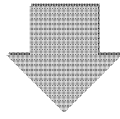

2. Connector/wiring check	<ul style="list-style-type: none">• Before beginning your work, be sure to turn off the ECU power.• Check the pin of the CAN communication connector for deformation and cracks, the condition of the connection, and whether the retainer is loose or removed.• Make sure that the CAN communication connector wiring is not cut or the wiring coating is not peeled.
---------------------------	--

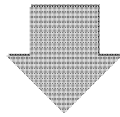

3. Failure diagnosis	<ul style="list-style-type: none">• Check the conduction of the wire-harness. <p>* See Chapter 2 P467 for details on the diagnosis method and procedure.</p>
----------------------	--

U0168: VI reception timeout

P code	U0168	Name	VI reception timeout
SPN/FMI	237/31		

● **DTC detection criteria**

1. Prerequisite, 2. Judgment criteria	Check points
1. The following conditions are all true: <ul style="list-style-type: none"> • Key switch is ON • Not in cranking status • Battery voltage is 10 V or higher 2. There is no response to the VIN request for 3 times.	Connector Wire-harness Controller of machine side ECU

● **Actions when an error occurs**

Fault mode	Limited operation is applied depending on each customer's setting.
Limited operation	The high idle speed or the engine output maximum injection quantity is limited. (Actions differ by the customer setting.)
Reset criteria	Yes: Resumes start when VI message is received.
Remarks	This function only applies to special models.

● **Presumed cause of the failure or the error condition**

1. CAN communication error from the controller on the driven machine
2. Poor connection of connector
3. Wire-harness disconnection/short circuit
4. ECU internal circuit failure

● **Diagnosis**

1. Initial diagnosis using SA-D	<ul style="list-style-type: none"> • Check the fault indication. * See Chapter 2 P467 for details on the diagnosis method and procedure.
---------------------------------	---

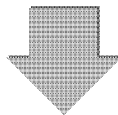

2. Connector/wiring check	<ul style="list-style-type: none"> • Before beginning your work, be sure to turn off the ECU power. • Check the pin of the CAN communication connector for deformation and cracks, the condition of the connection, and whether the retainer is loose or removed. • Make sure that the CAN communication connector wiring is not cut or the wiring coating is not peeled.
---------------------------	--

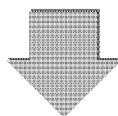

3. Failure diagnosis	<ul style="list-style-type: none"> • Check the conduction of the wire-harness. * See Chapter 2 P467 for details on the diagnosis method and procedure.
----------------------	---

U3002: VI reception data error

P code	U3002	Name	VI reception data error
SPN/FMI	237/13		

● DTC detection criteria

1. Prerequisite, 2. Judgment criteria	Check points
1. The following conditions are all true: <ul style="list-style-type: none"> • Key switch is ON • Not in cranking status • Battery voltage is 10 V or higher 2. The received VI does not match the existed VI in ECU.	Connector Wire-harness Controller of machine side ECU

● Actions when an error occurs

Fault mode	Limited operation is applied depending on each customer's setting.
Limited operation	The high idle speed or the engine output maximum injection quantity is limited. (Actions differ by the customer setting.)
Reset criteria	Yes: Resumes start when VI message is received.
Remarks	This function only applies to special models.

● Presumed cause of the failure or the error condition

1. CAN communication error from the controller on the driven machine
2. ECU internal circuit failure

U1300: Y_ETCP1 reception time out

P code	U1300	Name	Y_ETCP1 reception time out
SPN/FMI	522609/9		

● **DTC detection criteria**

1. Prerequisite, 2. Judgment criteria	Check points
1. The following conditions are all true: <ul style="list-style-type: none"> • Key switch is ON • Not in cranking status • Battery voltage is 10 V or higher 2. A reception time out is detected at a fixed time.	Connector Wire-harness Controller of machine side ECU

● **Actions when an error occurs**

Fault mode	[Continuous operation]: Engine control is not obstructed.
Limited operation	No
Reset criteria	Yes: The following operation can be selected by setting application. <ul style="list-style-type: none"> • When the ECU power is turned off, the fault mode is released. • The fault mode is automatically reset when Y_ETCP1 message is received.
Remarks	

● **Presumed cause of the failure or the error condition**

1. CAN communication error from the controller on the driven machine
2. Poor connection of connector
3. Wire-harness disconnection/short circuit
4. ECU internal circuit failure

● Diagnosis

1. Initial diagnosis using SA-D	<ul style="list-style-type: none">• Check the fault indication. <p>* See Chapter 2 P467 for details on the diagnosis method and procedure.</p>
---------------------------------	--

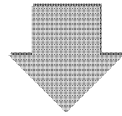

2. Connector/wiring check	<ul style="list-style-type: none">• Before beginning your work, be sure to turn off the ECU power.• Check the pin of the CAN communication connector for deformation and cracks, the condition of the connection, and whether the retainer is loose or removed.• Make sure that the CAN communication connector wiring is not cut or the wiring coating is not peeled.
---------------------------	--

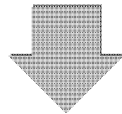

3. Failure diagnosis	<ul style="list-style-type: none">• Check the conduction of the wire-harness. <p>* See Chapter 2 P467 for details on the diagnosis method and procedure.</p>
----------------------	--

U1302: EBC1 reception timeout

P code	U1302	Name	EBC1 reception timeout
SPN/FMI	522618/9		

● **DTC detection criteria**

1. Prerequisite, 2. Judgment criteria	Check points
1. The following conditions are all true: <ul style="list-style-type: none"> • 2 seconds passes after the key switch was turned ON • Not in cranking status • ECU power is not OFF • Voltage value is 10 V or higher 2. A fixed time passes after a reception time out was detected for certain times. Count resets after normal communication.	Connector Wire-harness Controller of machine side ECU

● **Actions when an error occurs**

Fault mode	[Continuous operation]: Engine control is not obstructed.
Limited operation	No
Reset criteria	Yes: The following operation can be selected by setting application. <ul style="list-style-type: none"> • When the ECU power is turned off, the fault mode is released. • The fault mode is automatically reset when EBC1 message is received.
Remarks	

● **Presumed cause of the failure or the error condition**

1. CAN communication error from the controller on the driven machine
2. Poor connection of connector
3. Wire-harness disconnection/short circuit
4. ECU internal circuit failure

● Diagnosis

1. Initial diagnosis using SA-D	<ul style="list-style-type: none">• Check the fault indication. <p>* See Chapter 2 P467 for details on the diagnosis method and procedure.</p>
---------------------------------	--

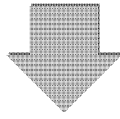

2. Connector/wiring check	<ul style="list-style-type: none">• Before beginning your work, be sure to turn off the ECU power.• Check the pin of the CAN communication connector for deformation and cracks, the condition of the connection, and whether the retainer is loose or removed.• Make sure that the CAN communication connector wiring is not cut or the wiring coating is not peeled.
---------------------------	--

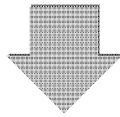

3. Failure diagnosis	<ul style="list-style-type: none">• Check the conduction of the wire-harness. <p>* See Chapter 2 P467 for details on the diagnosis method and procedure.</p>
----------------------	--

U1303: Y_DPFIF reception timeout

P code	U1303	Name	Y_DPFIF reception timeout
SPN/FMI	522619/9		

● **DTC detection criteria**

1. Prerequisite, 2. Judgment criteria	Check points
1. The following conditions are all true: <ul style="list-style-type: none"> • Key switch is ON • Not in cranking status • Battery voltage is 10 V or higher 2. A reception time out is detected at a fixed time.	Connector Wire-harness Controller of machine side ECU

● **Actions when an error occurs**

Fault mode	[Continuous operation]: Engine control is not obstructed.
Limited operation	No
Reset criteria	Yes: The following operation can be selected by setting application. <ul style="list-style-type: none"> • When the ECU power is turned off, the fault mode is released. • The fault mode is automatically reset when Y_DPFIF message is received.
Remarks	

● **Presumed cause of the failure or the error condition**

1. CAN communication error from the controller on the driven machine
2. Poor connection of connector
3. Wire-harness disconnection/short circuit
4. ECU internal circuit failure

● Diagnosis

1. Initial diagnosis using SA-D	<ul style="list-style-type: none">• Check the fault indication. <p>* See Chapter 2 P467 for details on the diagnosis method and procedure.</p>
---------------------------------	--

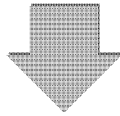

2. Connector/wiring check	<ul style="list-style-type: none">• Before beginning your work, be sure to turn off the ECU power.• Check the pin of the CAN communication connector for deformation and cracks, the condition of the connection, and whether the retainer is loose or removed.• Make sure that the CAN communication connector wiring is not cut or the wiring coating is not peeled.
---------------------------	--

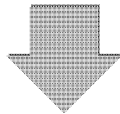

3. Failure diagnosis	<ul style="list-style-type: none">• Check the conduction of the wire-harness. <p>* See Chapter 2 P467 for details on the diagnosis method and procedure.</p>
----------------------	--

U0167: Immobilizer error (CAN communication)

P code	U0167	Name	Immobilizer error (CAN communication)
SPN/FMI	522730/12		

● **DTC detection criteria**

1. Prerequisite, 2. Judgment criteria	Check points
1. The following prerequisites should be satisfied. 1-The key switch is turned on for a given length of time 2-The battery normal condition is continued for given length of time 3-Immobilizer is active 4-Unit ID is stored 2. There is no reply from the immobilizer even after requesting to start authentication.	ECU Connector Wire-harness Immobilizer of machine side

● **Actions when an error occurs**

Fault mode	[Engine stop]: The engine does not start to operate.
Limited operation	Yes: The starter does not start.
Reset criteria	Yes: When the ECU power is turned off, the fault mode is released.
Remarks	

● **Presumed cause of the failure or the error condition**

1. CAN communication error of immobilizer (or the machine side controller)
2. Poor connection of connector
3. Wire-harness disconnection/short circuit
4. ECU internal circuit failure

U0426: Immobilizer error (system)

P code	U0426	Name	Immobilizer error (system)
SPN/FMI	1202/2		

● DTC detection criteria

1. Prerequisite, 2. Judgment criteria	Check points
1. The immobilizer is active and the unit ID is stored. 2. Authentication on CAN communication between the engine ECU and immobilizer failed.	Immobilizer authentication key Immobilizer of machine side

● Actions when an error occurs

Fault mode	[Engine stop]: The engine does not start to operate.
Limited operation	Yes: The starter does not start.
Reset criteria	Yes: When the ECU power is turned off, the fault mode is released.
Remarks	

● Presumed cause of the failure or the error condition

1. Immobilizer authentication key inconsistency

● Diagnosis

1. Check authentication key	• Make sure that the immobilizer authentication key is correct.
-----------------------------	---

ECU related

■ EEPROM

P0601: EEPROM memory deletion error

P code	P0601	Name	EEPROM memory deletion error
SPN/FMI	630/12		

● DTC detection criteria

1. Prerequisite, 2. Judgment criteria	Check points
1. When page (sector) switches. 2. EEPROM deletion malfunctions. The EEPROM has two pages and uses them alternately. When the first page becomes full, the second page will be cleared for writing into. Similarly, when the second page becomes full, the first page will be cleared for writing into. This error occurs when the page fails to be cleared during page switching.	ECU

● Actions when an error occurs

Fault mode	[Limited operation]: The engine operation is limited.
Limited operation	Yes: <ul style="list-style-type: none"> • When sensor error occurs, rated output of the engine is reduced immediately. • The maximum engine torque is limited to 85%. • EGR fully closes. • Rated output of the engine is reduced further after 120 min. • The maximum engine torque is limited to 50%.
Reset criteria	Yes: When the ECU power is turned off, the fault mode is released.
Remarks	

● Presumed cause of the failure or the error condition

1. ECU internal circuit failure

● Diagnosis

1. Initial diagnosis using SA-D	<ul style="list-style-type: none"> • Check the fault indication. • Switch the ECU power from ON to OFF to check the fault indication again. <p>* See Chapter 2 P470 for details on the diagnosis method and procedure.</p>
---------------------------------	--

P160E: EEPROM memory reading error

P code	P160E	Name	EEPROM memory reading error
SPN/FMI	522576/12		

● DTC detection criteria

1. Prerequisite, 2. Judgment criteria	Check points
1. When read-accessing. 2. EEPROM reading malfunctions. This error is determined based on the check sum, and this is performed on all EEPROM.	ECU

● Actions when an error occurs

Fault mode	[Limited operation]: The engine operation is limited.
Limited operation	Yes: <ul style="list-style-type: none"> • When sensor error occurs, rated output of the engine is reduced immediately. • The maximum engine torque is limited to 85%. • EGR fully closes. • Rated output of the engine is reduced further after 120 min. • The maximum engine torque is limited to 50%.
Reset criteria	Yes: When the ECU power is turned off, the fault mode is released.
Remarks	

● Presumed cause of the failure or the error condition

1. ECU internal circuit failure

● Diagnosis

1. Initial diagnosis using SA-D	<ul style="list-style-type: none"> • Check the fault indication. • Switch the ECU power from ON to OFF to check the fault indication again. <p>* See Chapter 2 P470 for details on the diagnosis method and procedure.</p>
---------------------------------	--

P160F: EEPROM memory writing error

P code	P160F	Name	EEPROM memory writing error
SPN/FMI	522578/12		

● **DTC detection criteria**

1. Prerequisite, 2. Judgment criteria	Check points
1. When write-accessing. 2. EEPROM writing malfunctions. This error occurs when there are 3 failed attempts to write one data.	ECU

● **Actions when an error occurs**

Fault mode	[Limited operation]: The engine operation is limited.
Limited operation	Yes: <ul style="list-style-type: none"> • When sensor error occurs, rated output of the engine is reduced immediately. • The maximum engine torque is limited to 85%. • EGR fully closes. • Rated output of the engine is reduced further after 120 min. • The maximum engine torque is limited to 50%.
Reset criteria	Yes: When the ECU power is turned off, the fault mode is released.
Remarks	

● **Presumed cause of the failure or the error condition**

1. ECU internal circuit failure

● **Diagnosis**

1. Initial diagnosis using SA-D	<ul style="list-style-type: none"> • Check the fault indication. • Switch the ECU power from ON to OFF to check the fault indication again. <p>* See Chapter 2 P470 for details on the diagnosis method and procedure.</p>
---------------------------------	--

■ ECU internal fault

P1613: CY146 SPI communication fault

P code	P1613	Name	CY146 SPI communication fault
SPN/FMI	522585/12		

● DTC detection criteria

1. Prerequisite, 2. Judgment criteria	Check points
1. No prerequisite. 2. A communication fault between the CPU and the H bridge control IC.	ECU

● Actions when an error occurs

Fault mode	[Engine stop]: The engine operation stops.
Limited operation	Yes: Fuel injection stops.
Reset criteria	Yes: When the ECU power is turned off, the fault mode is released.
Remarks	

● Presumed cause of the failure or the error condition

1. ECU internal circuit failure

● Diagnosis

1. Initial diagnosis using SA-D	<ul style="list-style-type: none"> • Check the fault indication. • Switch the ECU power from ON to OFF to check the fault indication again. • If this DTC is detected again, exchange the ECU.
---------------------------------	---

P1608: Excessive voltage of supply 1

P code	P1608	Name	Excessive voltage of supply 1
SPN/FMI	522588/12		

● DTC detection criteria

1. Prerequisite, 2. Judgment criteria	Check points
1. No prerequisite. 2. The 5 V supply voltage to the actuator drive is excessive.	ECU

● Actions when an error occurs

Fault mode	[Engine stop]: The engine operation stops.
Limited operation	Yes: Fuel injection stops.
Reset criteria	Yes: When the ECU power is turned off, the fault mode is released.
Remarks	

● Presumed cause of the failure or the error condition

1. ECU internal circuit failure

● Diagnosis

1. Initial diagnosis using SA-D	<ul style="list-style-type: none"> • Check the fault indication. • Switch the ECU power from ON to OFF to check the fault indication again. • If this DTC is detected again, exchange the ECU.
---------------------------------	---

P1617: Insufficient voltage of supply 1

P code	P1617	Name	Insufficient voltage of supply 1
SPN/FMI	522589/12		

● DTC detection criteria

1. Prerequisite, 2. Judgment criteria	Check points
1. No prerequisite. 2. The 5 V supply voltage to the actuator drive is insufficient.	ECU

● Actions when an error occurs

Fault mode	[Engine stop]: The engine operation stops.
Limited operation	Yes: Fuel injection stops.
Reset criteria	Yes: When the ECU power is turned off, the fault mode is released.
Remarks	

● Presumed cause of the failure or the error condition

1. ECU internal circuit failure

● Diagnosis

1. Initial diagnosis using SA-D	<ul style="list-style-type: none"> • Check the fault indication. • Switch the ECU power from ON to OFF to check the fault indication again. • If this DTC is detected again, exchange the ECU.
---------------------------------	---

P1031: Shutoff 1 due to ECU internal abnormality

P code	P1031	Name	Shutoff 1 due to ECU internal abnormality
SPN/FMI	518468/12		

● **DTC detection criteria**

1. Prerequisite, 2. Judgment criteria	Check points
1. When the battery voltage is higher than 8V, and it is not under the shut-off pass test (operational diagnosis of the injector power cut-off function) by the external monitoring IC and CPU performed after the ECU power is turned on. 2. Other abnormalities caused by an external monitoring IC (other than watchdog and overvoltage abnormalities) shut off is occurring.	ECU

● **Actions when an error occurs**

Fault mode	[Engine stop]: The engine operation stops.
Limited operation	Yes: Fuel injection stops.
Reset criteria	Yes: When the ECU power is turned off, the fault mode is released.
Remarks	

● **Presumed cause of the failure or the error condition**

1. ECU internal circuit failure

● **Diagnosis**

1. Initial diagnosis using SA-D	<ul style="list-style-type: none"> • Check the fault indication. • Switch the ECU power from ON to OFF to check the fault indication again. • If this DTC is detected again, exchange the ECU.
---------------------------------	---

P1032: Shutoff 2 due to ECU internal abnormality

P code	P1032	Name	Shutoff 2 due to ECU internal abnormality
SPN/FMI	518469/12		

● DTC detection criteria

1. Prerequisite, 2. Judgment criteria	Check points
1. When it is not a shut-off pass test (operational diagnosis of the injector power cut-off function) by the external monitoring IC and CPU that is performed after the ECU power is turned on. 2. When shutoff occurs due to the watchdog of the external monitoring IC.	ECU

● Actions when an error occurs

Fault mode	[Engine stop]: The engine operation stops.
Limited operation	Yes: Fuel injection stops.
Reset criteria	Yes: When the ECU power is turned off, the fault mode is released.
Remarks	

● Presumed cause of the failure or the error condition

1. ECU internal circuit failure

● Diagnosis

1. Initial diagnosis using SA-D	<ul style="list-style-type: none"> • Check the fault indication. • Switch the ECU power from ON to OFF to check the fault indication again. • If this DTC is detected again, exchange the ECU.
---------------------------------	---

P1033: Shutoff 3 due to ECU internal abnormality

P code	P1033	Name	Shutoff 3 due to ECU internal abnormality
SPN/FMI	518470/12		

● **DTC detection criteria**

1. Prerequisite, 2. Judgment criteria	Check points
1. When it is not a shut-off pass test (operational diagnosis of the injector power cut-off function) by the external monitoring IC and CPU that is performed after the ECU power is turned on. 2. When any of the following is detected: <ul style="list-style-type: none"> • Shut-off occurs due to microcomputer self-diagnosis. • Occurrence of injection control abnormality. • Occurrence of driver-software abnormality. 	ECU

● **Actions when an error occurs**

Fault mode	[Engine stop]: The engine operation stops.
Limited operation	Yes: Fuel injection stops.
Reset criteria	Yes: When the ECU power is turned off, the fault mode is released.
Remarks	

● **Presumed cause of the failure or the error condition**

1. ECU internal circuit failure

● **Diagnosis**

1. Initial diagnosis using SA-D	<ul style="list-style-type: none"> • Check the fault indication. • Switch the ECU power from ON to OFF to check the fault indication again. • If this DTC is detected again, exchange the ECU.
---------------------------------	---

P1034: Shutoff 4 due to ECU internal abnormality

P code	P1034	Name	Shutoff 4 due to ECU internal abnormality
SPN/FMI	518471/12		

● DTC detection criteria

1. Prerequisite, 2. Judgment criteria	Check points
1. When it is not a shut-off pass test (operational diagnosis of the injector power cut-off function) by the external monitoring IC and CPU that is performed after the ECU power is turned on. 2. When shut-off occurs due to overvoltage of the external monitoring IC.	ECU

● Actions when an error occurs

Fault mode	[Engine stop]: The engine operation stops.
Limited operation	Yes: Fuel injection stops.
Reset criteria	Yes: When the ECU power is turned off, the fault mode is released.
Remarks	

● Presumed cause of the failure or the error condition

1. ECU internal circuit failure

● Diagnosis

1. Initial diagnosis using SA-D	<ul style="list-style-type: none"> • Check the fault indication. • Switch the ECU power from ON to OFF to check the fault indication again. • If this DTC is detected again, exchange the ECU.
---------------------------------	---

P1609: Sensor supply voltage error 1

P code	P1609	Name	Sensor supply voltage error 1
SPN/FMI	522590/12		

● **DTC detection criteria**

1. Prerequisite, 2. Judgment criteria	Check points
1. No prerequisite. 2. The 5 V supply voltage of sensor exceeds the threshold value.	Connector Wire-harness ECU

● **Actions when an error occurs**

Fault mode	[Continuous operation]: Engine control is not obstructed.
Limited operation	No
Reset criteria	Yes: When the ECU power off is detected, the fault mode is released.
Remarks	

● **Presumed cause of the failure or the error condition**

1. Poor connection of connector of the sensor that uses sensor power supply 1 (K43 or K44 terminal)
2. Wiring failure of the wire-harness
3. ECU internal circuit failure

● **Diagnosis**

1. Initial diagnosis using SA-D	<ul style="list-style-type: none"> • Check the fault indication.
---------------------------------	---

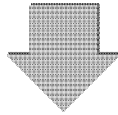

2. Connector/wiring check	<ul style="list-style-type: none"> • Before beginning your work, be sure to turn off the ECU power. • Check the pin of sensor that uses sensor power supply 1 (K43 or K44 terminal) for deformation and cracks, the condition of the connection, and whether the retainer is loose or removed. • Make sure that the sensor that uses sensor power supply 1 wiring is not cut or the wiring coating is not peeled.
---------------------------	--

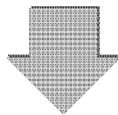

3. Failure diagnosis	<ul style="list-style-type: none"> • Check the fault indication again. • If this DTC is detected again, exchange the wire-harness or ECU.
----------------------	---

P1618: Sensor supply voltage error 2

P code	P1618	Name	Sensor supply voltage error 2
SPN/FMI	522591/12		

● DTC detection criteria

1. Prerequisite, 2. Judgment criteria	Check points
1. No prerequisite. 2. The 5 V supply voltage of sensor exceeds the threshold value.	Connector Wire-harness ECU

● Actions when an error occurs

Fault mode	[Continuous operation]: Engine control is not obstructed.
Limited operation	No
Reset criteria	Yes: When the ECU power off is detected, the fault mode is released.
Remarks	

● Presumed cause of the failure or the error condition

1. Poor connection of connector of the sensor that uses sensor power supply 2 (K45 or A08 terminal)
2. Wiring failure of the wire-harness
3. ECU internal circuit failure

● Diagnosis

1. Initial diagnosis using SA-D	• Check the fault indication.
---------------------------------	-------------------------------

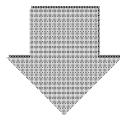

2. Connector/wiring check	<ul style="list-style-type: none"> • Before beginning your work, be sure to turn off the ECU power. • Check the pin of sensor that uses sensor power supply 2 (K45 or A08 terminal) for deformation and cracks, the condition of the connection, and whether the retainer is loose or removed. • Make sure that the sensor that uses sensor power supply 2 wiring is not cut or the wiring coating is not peeled.
---------------------------	--

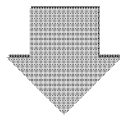

3. Failure diagnosis	<ul style="list-style-type: none"> • Check the fault indication again. • If this DTC is detected again, exchange the wire-harness or ECU.
----------------------	---

P1619: Sensor supply voltage error 3

P code	P1619	Name	Sensor supply voltage error 3
SPN/FMI	522592/12		

● **DTC detection criteria**

1. Prerequisite, 2. Judgment criteria	Check points
1. No prerequisite. 2. The 5 V supply voltage of sensor exceeds the threshold value.	Connector Wire-harness ECU

● **Actions when an error occurs**

Fault mode	[Continuous operation]: Engine control is not obstructed.
Limited operation	No
Reset criteria	Yes: When the ECU power off is detected, the fault mode is released.
Remarks	

● **Presumed cause of the failure or the error condition**

1. Poor connection of connector of the sensor that uses sensor power supply 3 (A07 terminal)
2. Wiring failure of the wire-harness
3. ECU internal circuit failure

● **Diagnosis**

1. Initial diagnosis using SA-D	<ul style="list-style-type: none"> • Check the fault indication.
---------------------------------	---

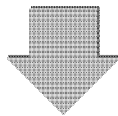

2. Connector/wiring check	<ul style="list-style-type: none"> • Before beginning your work, be sure to turn off the ECU power. • Check the pin of sensor that uses sensor power supply 3 (A07 terminal) for deformation and cracks, the condition of the connection, and whether the retainer is loose or removed. • Make sure that the sensor that uses sensor power supply 3 wiring is not cut or the wiring coating is not peeled.
---------------------------	---

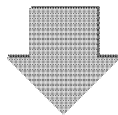

3. Failure diagnosis	<ul style="list-style-type: none"> • Check the fault indication again. • If this DTC is detected again, exchange the wire-harness or ECU.
----------------------	---

P1689: Sensor supply voltage error 4

P code	P1689	Name	Sensor supply voltage error 4
SPN/FMI	518479/12		

● **DTC detection criteria**

1. Prerequisite, 2. Judgment criteria	Check points
1. No prerequisite. 2. The 5 V supply voltage of sensor exceeds the threshold value.	Connector Wire-harness ECU

● **Actions when an error occurs**

Fault mode	[Continuous operation]: Engine control is not obstructed.
Limited operation	No
Reset criteria	Yes: When the ECU power off is detected, the fault mode is released.
Remarks	

● **Presumed cause of the failure or the error condition**

1. Poor connection of connector of the sensor that uses sensor power supply 4 (K24 terminal)
2. Wiring failure of the wire-harness
3. ECU internal circuit failure

● **Diagnosis**

1. Initial diagnosis using SA-D	<ul style="list-style-type: none"> • Check the fault indication.
---------------------------------	---

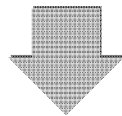

2. Connector/wiring check	<ul style="list-style-type: none"> • Before beginning your work, be sure to turn off the ECU power. • Check the pin of sensor that uses sensor power supply 4 (K24 terminal) for deformation and cracks, the condition of the connection, and whether the retainer is loose or removed. • Make sure that the sensor that uses sensor power supply 4 wiring is not cut or the wiring coating is not peeled.
---------------------------	---

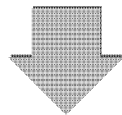

3. Failure diagnosis	<ul style="list-style-type: none"> • Check the fault indication again. • If this DTC is detected again, exchange the wire-harness or ECU.
----------------------	---

P1626: Actuator drive circuit 1 short to ground

P code	P1626	Name	Actuator drive circuit 1 short to ground
SPN/FMI	522744/4		

● **DTC detection criteria**

1. Prerequisite, 2. Judgment criteria	Check points
1. No prerequisite. 2. The overcurrent in UB2 terminal is detected by IC in the ECU.	Connector Wire-harness ECU

● **Actions when an error occurs**

Fault mode	[Continuous operation]: Engine control is not obstructed.
Limited operation	No
Reset criteria	Yes: When the ECU power off is detected, the fault mode is released.
Remarks	

● **Presumed cause of the failure or the error condition**

1. Poor connection of connector of the actuator that uses 12 V power supply 1 (UB2: K68 terminal)
2. Wiring failure of the wire-harness
 - GND short circuit of the 12 V power supply 1 (UB2: K68 terminal) wire
3. ECU internal circuit failure

● **Diagnosis**

1. Initial diagnosis using SA-D	• Check the fault indication.
---------------------------------	-------------------------------

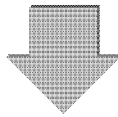

2. Connector/wiring check	<ul style="list-style-type: none"> • Before beginning your work, be sure to turn off the ECU power. • Check the pin of the actuator that uses 12 V power supply 1 (UB2: K68 terminal) for deformation and cracks, the condition of the connection, and whether the retainer is loose or removed. • Make sure that the actuator that uses 12 V power supply 1 wiring is not cut or the wiring coating is not peeled.
---------------------------	--

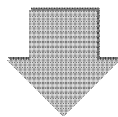

3. Failure diagnosis	<ul style="list-style-type: none"> • Check the fault indication again. • If this DTC is detected again, exchange the wire-harness or ECU.
----------------------	---

P1633: Actuator drive circuit 2 short to ground

P code	P1633	Name	Actuator drive circuit 2 short to ground
SPN/FMI	522994/4		

● DTC detection criteria

1. Prerequisite, 2. Judgment criteria	Check points
1. No prerequisite. 2. The overcurrent in UB3 terminal is detected by IC in the ECU.	Connector Wire-harness ECU

● Actions when an error occurs

Fault mode	[Continuous operation]: Engine control is not obstructed.
Limited operation	No
Reset criteria	Yes: When the ECU power off is detected, the fault mode is released.
Remarks	

● Presumed cause of the failure or the error condition

1. Poor connection of connector of the actuator that uses 12 V power supply 2 (UB3: K90 or A50 terminal)
2. Wiring failure of the wire-harness
 - GND short circuit of the 12 V power supply 2 (UB3: K90 or A50 terminal) wire
3. ECU internal circuit failure

● Diagnosis

1. Initial diagnosis using SA-D	• Check the fault indication.
---------------------------------	-------------------------------

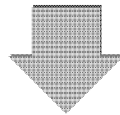

2. Connector/wiring check	<ul style="list-style-type: none"> • Before beginning your work, be sure to turn off the ECU power. • Check the pin of the actuator that uses 12 V power supply 2 (UB3: K90 or A50 terminal) for deformation and cracks, the condition of the connection, and whether the retainer is loose or removed. • Make sure that the actuator that uses 12 V power supply 2 wiring is not cut or the wiring coating is not peeled.
---------------------------	---

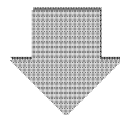

3. Failure diagnosis	<ul style="list-style-type: none"> • Check the fault indication again. • If this DTC is detected again, exchange the wire-harness or ECU.
----------------------	---

P1467: Actuator drive circuit 3 short to ground

P code	P1467	Name	Actuator drive circuit 3 short to ground
SPN/FMI	523471/6		

● **DTC detection criteria**

1. Prerequisite, 2. Judgment criteria	Check points
1. No prerequisite. 2. The overcurrent in UB5 terminal is detected by IC in the ECU.	Connector Wire-harness ECU

● **Actions when an error occurs**

Fault mode	[Continuous operation]: Engine control is not obstructed.
Limited operation	No
Reset criteria	Yes: When the ECU power off is detected, the fault mode is released.
Remarks	

● **Presumed cause of the failure or the error condition**

1. Poor connection of connector of the actuator that uses 12 V power supply 3 (UB5: K73 terminal)
2. Wiring failure of the wire-harness
 - GND short circuit of the 12 V power supply 3 (UB5: K73 terminal) wire
3. ECU internal circuit failure

● **Diagnosis**

1. Initial diagnosis using SA-D	• Check the fault indication.
---------------------------------	-------------------------------

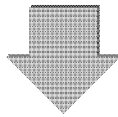

2. Connector/wiring check	<ul style="list-style-type: none"> • Before beginning your work, be sure to turn off the ECU power. • Check the pin of the actuator that uses 12 V power supply 3 (UB5: K73 terminal) for deformation and cracks, the condition of the connection, and whether the retainer is loose or removed. • Make sure that the actuator that uses 12 V power supply 3 wiring is not cut or the wiring coating is not peeled.
---------------------------	--

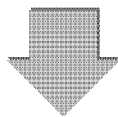

3. Failure diagnosis	<ul style="list-style-type: none"> • Check the fault indication again. • If this DTC is detected again, exchange the wire-harness or ECU.
----------------------	---

P1469: AD converter fault 1

P code	P1469	Name	AD converter fault 1
SPN/FMI	523473/12		

● DTC detection criteria

1. Prerequisite, 2. Judgment criteria	Check points
1. No prerequisite. 2. A pulse error is detected through diagnosis of the AD converter.	ECU

● Actions when an error occurs

Fault mode	[Engine stop]: The engine operation stops.
Limited operation	Yes: Fuel injection stops.
Reset criteria	Yes: When the ECU power is turned off, the fault mode is released.
Remarks	

● Presumed cause of the failure or the error condition

1. ECU internal circuit failure

● Diagnosis

1. Initial diagnosis using SA-D	<ul style="list-style-type: none"> • Check the fault indication. • Switch the ECU power from ON to OFF to check the fault indication again. • If this DTC is detected again, exchange the ECU.
---------------------------------	---

P1470: AD converter fault 2

P code	P1470	Name	AD converter fault 2
SPN/FMI	523474/12		

● DTC detection criteria

1. Prerequisite, 2. Judgment criteria	Check points
1. No prerequisite. 2. A voltage error is detected through diagnosis of the AD converter.	ECU

● Actions when an error occurs

Fault mode	[Engine stop]: The engine operation stops.
Limited operation	Yes: Fuel injection stops.
Reset criteria	Yes: When the ECU power is turned off, the fault mode is released.
Remarks	

● Presumed cause of the failure or the error condition

1. ECU internal circuit failure

● Diagnosis

1. Initial diagnosis using SA-D	<ul style="list-style-type: none"> • Check the fault indication. • Switch the ECU power from ON to OFF to check the fault indication again. • If this DTC is detected again, exchange the ECU.
---------------------------------	---

P1471: External monitoring IC and CPU fault 1

P code	P1471	Name	External monitoring IC and CPU fault 1
SPN/FMI	523475/12		

● DTC detection criteria

1. Prerequisite, 2. Judgment criteria	Check points
1. No prerequisite. 2. An error is detected through mutual diagnosis of the external monitoring IC and the CPU.	ECU

● Actions when an error occurs

Fault mode	[Engine stop]: The engine operation stops.
Limited operation	Yes: Fuel injection stops.
Reset criteria	Yes: When the ECU power is turned off, the fault mode is released.
Remarks	

● Presumed cause of the failure or the error condition

1. ECU internal circuit failure

● Diagnosis

1. Initial diagnosis using SA-D	<ul style="list-style-type: none"> • Check the fault indication. • Switch the ECU power from ON to OFF to check the fault indication again. • If this DTC is detected again, exchange the ECU.
---------------------------------	---

P1472: External monitoring IC and CPU fault 2

P code	P1472	Name	External monitoring IC and CPU fault 2
SPN/FMI	523476/12		

● **DTC detection criteria**

1. Prerequisite, 2. Judgment criteria	Check points
1. No prerequisite. 2. A communication error is detected between the external monitoring IC and the CPU.	ECU

● **Actions when an error occurs**

Fault mode	[Engine stop]: The engine operation stops.
Limited operation	Yes: Fuel injection stops.
Reset criteria	Yes: When the ECU power is turned off, the fault mode is released.
Remarks	

● **Presumed cause of the failure or the error condition**

1. ECU internal circuit failure

● **Diagnosis**

1. Initial diagnosis using SA-D	<ul style="list-style-type: none"> • Check the fault indication. • Switch the ECU power from ON to OFF to check the fault indication again. • If this DTC is detected again, exchange the ECU.
---------------------------------	---

P1473: ROM fault

P code	P1473	Name	ROM fault
SPN/FMI	523477/12		

● DTC detection criteria

1. Prerequisite, 2. Judgment criteria	Check points
1. ECU power self-maintains after the key switch was turned OFF. 2. The checksum of the all ROM areas is abnormal.	ECU

● Actions when an error occurs

Fault mode	[Engine stop]: The engine operation stops.
Limited operation	Yes: Fuel injection stops.
Reset criteria	Yes: When the ECU power is turned off, the fault mode is released.
Remarks	

● Presumed cause of the failure or the error condition

1. ECU internal circuit failure

● Diagnosis

1. Initial diagnosis using SA-D	<ul style="list-style-type: none"> • Check the fault indication. • Switch the ECU power from ON to OFF to check the fault indication again. • If this DTC is detected again, exchange the ECU.
---------------------------------	---

P1474: Shutoff path fault 1

P code	P1474	Name	Shutoff path fault 1
SPN/FMI	523478/12		

● **DTC detection criteria**

1. Prerequisite, 2. Judgment criteria	Check points
1. During shutoff path test (operation diagnosis of the isolation function of injector current) by the external monitoring IC, which is implemented after turning on the ECU power. 2. A response error from CPU to the external monitoring IC is detected by the external monitoring IC.	ECU

● **Actions when an error occurs**

Fault mode	[Engine stop]: The engine operation stops.
Limited operation	Yes: Fuel injection stops.
Reset criteria	Yes: When the ECU power is turned off, the fault mode is released.
Remarks	

● **Presumed cause of the failure or the error condition**

1. ECU internal circuit failure

● **Diagnosis**

1. Initial diagnosis using SA-D	<ul style="list-style-type: none"> • Check the fault indication. • Switch the ECU power from ON to OFF to check the fault indication again. • If this DTC is detected again, exchange the ECU.
---------------------------------	---

P1475: Shutoff path fault 2

P code	P1475	Name	Shutoff path fault 2
SPN/FMI	523479/12		

● **DTC detection criteria**

1. Prerequisite, 2. Judgment criteria	Check points
1. During shutoff path test (operation diagnosis of the isolation function of injector current) by the external monitoring IC, which is implemented after turning on the ECU power. 2. An operation error of shutoff path test is detected by the external monitoring IC.	ECU

● **Actions when an error occurs**

Fault mode	[Limited operation]: The engine operation is limited.
Limited operation	Yes: <ul style="list-style-type: none"> • When sensor error occurs, rated output of the engine is reduced immediately. • The maximum engine torque is limited to 85%. • EGR fully closes. • Rated output of the engine is reduced further after 120 min. • The maximum engine torque is limited to 50%.
Reset criteria	Yes: When the ECU power is turned off, the fault mode is released.
Remarks	

● **Presumed cause of the failure or the error condition**

1. ECU internal circuit failure
2. When turning on the ECU power, all the injectors in the same bank (4-cylinder engines: 1st and 4th cylinders or 2nd and 3rd cylinders. 3-cylinder engines: All cylinders) are disconnected.

● **Diagnosis**

1. Initial diagnosis using SA-D	<ul style="list-style-type: none"> • Check the fault indication. • Start the engine. If an error occurs to the injector driving circuit (bank 1 (or 2) error), the injectors may be disconnected at the same time. Refer to the pages that describes the injector disconnection, and troubleshoot the injector circuit of the said bank. • If the engine does not start and shut-off bus error other than this error also occurs, there may be other failure causes. Perform troubleshooting for the detected error code. • Switch the ECU power from ON to OFF to check the fault indication again. • If this DTC is detected again, exchange the ECU.
---------------------------------	--

P1476: Shutoff path fault 3

P code	P1476	Name	Shutoff path fault 3
SPN/FMI	523480/12		

● **DTC detection criteria**

1. Prerequisite, 2. Judgment criteria	Check points
1. During shutoff path test (operation diagnosis of the isolation function of injector current) by the external monitoring IC, which is implemented after turning on the ECU power. 2. A response time error of shutoff path test is detected by the external monitoring IC.	ECU

● **Actions when an error occurs**

Fault mode	[Engine stop]: The engine operation stops.
Limited operation	Yes: Fuel injection stops.
Reset criteria	Yes: When the ECU power is turned off, the fault mode is released.
Remarks	

● **Presumed cause of the failure or the error condition**

1. ECU internal circuit failure

● **Diagnosis**

1. Initial diagnosis using SA-D	<ul style="list-style-type: none"> • Check the fault indication. • Switch the ECU power from ON to OFF to check the fault indication again. • If this DTC is detected again, exchange the ECU.
---------------------------------	---

P1477: Shutoff path fault 4

P code	P1477	Name	Shutoff path fault 4
SPN/FMI	523481/12		

● DTC detection criteria

1. Prerequisite, 2. Judgment criteria	Check points
1. During shutoff path test (operation diagnosis of the isolation function of injector current) by the external monitoring IC, which is implemented after turning on the ECU power. 2. A communication error of shutoff path test is detected by the external monitoring IC.	ECU

● Actions when an error occurs

Fault mode	[Engine stop]: The engine operation stops.
Limited operation	Yes: Fuel injection stops.
Reset criteria	Yes: When the ECU power is turned off, the fault mode is released.
Remarks	

● Presumed cause of the failure or the error condition

1. ECU internal circuit failure

● Diagnosis

1. Initial diagnosis using SA-D	<ul style="list-style-type: none"> • Check the fault indication. • Switch the ECU power from ON to OFF to check the fault indication again. • If this DTC is detected again, exchange the ECU.
---------------------------------	---

P1478: Shutoff path fault 5

P code	P1478	Name	Shutoff path fault 5
SPN/FMI	523482/12		

● **DTC detection criteria**

1. Prerequisite, 2. Judgment criteria	Check points
1. During shutoff path test (operation diagnosis of the isolation function of injector current) by the external monitoring IC, which is implemented after turning on the ECU power. 2. An insufficient value of voltage in shutoff path test is detected by the external monitoring IC.	ECU

● **Actions when an error occurs**

Fault mode	[Engine stop]: The engine operation stops.
Limited operation	Yes: Fuel injection stops.
Reset criteria	Yes: When the ECU power is turned off, the fault mode is released.
Remarks	

● **Presumed cause of the failure or the error condition**

1. ECU internal circuit failure

● **Diagnosis**

1. Initial diagnosis using SA-D	<ul style="list-style-type: none"> • Check the fault indication. • Switch the ECU power from ON to OFF to check the fault indication again. • If this DTC is detected again, exchange the ECU.
---------------------------------	---

P1479: Shutoff path fault 6

P code	P1479	Name	Shutoff path fault 6
SPN/FMI	523483/12		

● DTC detection criteria

1. Prerequisite, 2. Judgment criteria	Check points
1. During shutoff path test (operation diagnosis of the isolation function of injector current) by the external monitoring IC, which is implemented after turning on the ECU power. 2. An error of the external monitoring IC in shutoff path test is detected by the external monitoring IC.	ECU

● Actions when an error occurs

Fault mode	[Engine stop]: The engine operation stops.
Limited operation	Yes: Fuel injection stops.
Reset criteria	Yes: When the ECU power is turned off, the fault mode is released.
Remarks	

● Presumed cause of the failure or the error condition

1. ECU internal circuit failure

● Diagnosis

1. Initial diagnosis using SA-D	<ul style="list-style-type: none"> • Check the fault indication. • Switch the ECU power from ON to OFF to check the fault indication again. • If this DTC is detected again, exchange the ECU.
---------------------------------	---

P1480: Shutoff path fault 7

P code	P1480	Name	Shutoff path fault 7
SPN/FMI	523484/12		

● **DTC detection criteria**

1. Prerequisite, 2. Judgment criteria	Check points
1. During shutoff path test (operation diagnosis of the isolation function of injector current) by the external monitoring IC, which is implemented after turning on the ECU power. 2. An error of OS call time in shutoff path test is detected by the external monitoring IC.	ECU

● **Actions when an error occurs**

Fault mode	[Engine stop]: The engine operation stops.
Limited operation	Yes: Fuel injection stops.
Reset criteria	Yes: When the ECU power is turned off, the fault mode is released.
Remarks	

● **Presumed cause of the failure or the error condition**

1. ECU internal circuit failure

● **Diagnosis**

1. Initial diagnosis using SA-D	<ul style="list-style-type: none"> • Check the fault indication. • Switch the ECU power from ON to OFF to check the fault indication again. • If this DTC is detected again, exchange the ECU.
---------------------------------	---

P1481: Shutoff path fault 8

P code	P1481	Name	Shutoff path fault 8
SPN/FMI	523485/12		

● DTC detection criteria

1. Prerequisite, 2. Judgment criteria	Check points
1. During shutoff path test (operation diagnosis of the isolation function of injector current) by the external monitoring IC, which is implemented after turning on the ECU power. 2. An error of positive test of shutoff path test is detected by the external monitoring IC.	ECU

● Actions when an error occurs

Fault mode	[Engine stop]: The engine operation stops.
Limited operation	Yes: Fuel injection stops.
Reset criteria	Yes: When the ECU power is turned off, the fault mode is released.
Remarks	

● Presumed cause of the failure or the error condition

1. ECU internal circuit failure

● Diagnosis

1. Initial diagnosis using SA-D	<ul style="list-style-type: none"> • Check the fault indication. • Switch the ECU power from ON to OFF to check the fault indication again. • If this DTC is detected again, exchange the ECU.
---------------------------------	---

P1482: Shutoff path fault 9

P code	P1482	Name	Shutoff path fault 9
SPN/FMI	523486/12		

● **DTC detection criteria**

1. Prerequisite, 2. Judgment criteria	Check points
1. During shutoff path test (operation diagnosis of the isolation function of injector current) by the external monitoring IC, which is implemented after turning on the ECU power. 2. An error of operation time of shutoff path test is detected by the external monitoring IC.	ECU

● **Actions when an error occurs**

Fault mode	[Engine stop]: The engine operation stops.
Limited operation	Yes: Fuel injection stops.
Reset criteria	Yes: When the ECU power is turned off, the fault mode is released.
Remarks	

● **Presumed cause of the failure or the error condition**

1. ECU internal circuit failure

● **Diagnosis**

1. Initial diagnosis using SA-D	<ul style="list-style-type: none"> • Check the fault indication. • Switch the ECU power from ON to OFF to check the fault indication again. • If this DTC is detected again, exchange the ECU.
---------------------------------	---

P1483: Shutoff path fault 10

P code	P1483	Name	Shutoff path fault 10
SPN/FMI	523487/12		

● DTC detection criteria

1. Prerequisite, 2. Judgment criteria	Check points
1. During shutoff path test (operation diagnosis of the isolation function of injector current) by the external monitoring IC, which is implemented after turning on the ECU power. 2. An excessive value of voltage in shutoff path test is detected by the external monitoring IC.	ECU

● Actions when an error occurs

Fault mode	[Engine stop]: The engine operation stops.
Limited operation	Yes: Fuel injection stops.
Reset criteria	Yes: When the ECU power is turned off, the fault mode is released.
Remarks	

● Presumed cause of the failure or the error condition

1. ECU internal circuit failure

● Diagnosis

1. Initial diagnosis using SA-D	<ul style="list-style-type: none"> • Check the fault indication. • Switch the ECU power from ON to OFF to check the fault indication again. • If this DTC is detected again, exchange the ECU.
---------------------------------	---

P1035: Shut-off path abnormality by external monitoring IC and CPU

P code	P1035	Name	Shut-off path abnormality by external monitoring IC and CPU
SPN/FMI	518472/12		

● **DTC detection criteria**

1. Prerequisite, 2. Judgment criteria	Check points
1. At a diagnostic test (operational diagnosis of the injector power cut-off function) performed by the external monitoring IC and CPU after the ECU power is turned on. 2. When an error is detected in the shut-off path diagnosis by the external monitoring IC and CPU.	ECU

● **Actions when an error occurs**

Fault mode	[Engine stop]: The engine operation stops.
Limited operation	Yes: Fuel injection stops.
Reset criteria	Yes: When the ECU power is turned off, the fault mode is released.
Remarks	

● **Presumed cause of the failure or the error condition**

1. ECU internal circuit failure

● **Diagnosis**

1. Initial diagnosis using SA-D	<ul style="list-style-type: none"> • Check the fault indication. • Switch the ECU power from ON to OFF to check the fault indication again. • If this DTC is detected again, exchange the ECU.
---------------------------------	---

P1484: Recognition error of engine speed

P code	P1484	Name	Recognition error of engine speed
SPN/FMI	523488/0		

● DTC detection criteria

1. Prerequisite, 2. Judgment criteria	Check points
1. No prerequisite. 2. An error is detected through mutual diagnosis of engine speed.	ECU

● Actions when an error occurs

Fault mode	[Engine stop]: The engine operation stops.
Limited operation	Yes: Fuel injection stops.
Reset criteria	Yes: When the ECU power is turned off, the fault mode is released.
Remarks	

● Presumed cause of the failure or the error condition

1. ECU internal circuit failure

● Diagnosis

1. Initial diagnosis using SA-D	<ul style="list-style-type: none"> • Check the fault indication. • Switch the ECU power from ON to OFF to check the fault indication again. • If this DTC is detected again, exchange the ECU.
---------------------------------	---

Contact output related

■ Breather heater (Optional parts for 4TNV86CT and 4TNV98CT)

P053A: Breather heater disconnection

P code	P053A	Name	Breather heater disconnection
SPN/FMI	3059/5		

● DTC detection criteria

1. Prerequisite, 2. Judgment criteria	Check points
1. The following prerequisites should be satisfied: <ul style="list-style-type: none"> • The heater is not energized (1 second after ECU is activated) • No abnormality in coolant temperature sensor • Engine coolant temperature is 40 °C or lower 2. Disconnection detected in the ECU internal circuit of the A34 terminal.	Breather heater Wire-harness

● Actions when an error occurs

Fault mode	[Continuous operation]: The engine continues to operate without limitations after the error is detected.
Limited operation	No
Reset criteria	Yes: When the ECU power is turned off, the fault mode is released.
Remarks	

● Presumed cause of the failure or the error condition

1. Disconnection in the internal circuit of the breather heater

● Diagnosis

1. Initial diagnosis using SA-D	<ul style="list-style-type: none"> • Check the fault indication. • Check the fault indication again by turning the ECU on and off. • If DTC is detected again, inspect the breather heater and wire-harness, and replace them if necessary.
---------------------------------	--

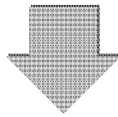

2. Failure diagnosis	<ul style="list-style-type: none"> • Check the resistance value of the breather heater. • Check the continuity of the harness. <p>* See Chapter 2 P417 for details on the diagnosis method and procedure.</p>
----------------------	---

P053B: Breather heater short circuit (GND)

P code	P053B	Name	Breather heater short circuit (GND)
SPN/FMI	3059/4		

● DTC detection criteria

1. Prerequisite, 2. Judgment criteria	Check points
1. The following prerequisites should be satisfied: <ul style="list-style-type: none"> • The heater is not energized (1 second after ECU is activated) • No abnormality is coolant temperature sensor • Engine coolant temperature is 40 °C or lower 2. GND short circuit detected in the ECU internal circuit of the A34 terminal.	Breather heater Wire-harness

● Actions when an error occurs

Fault mode	[Continuous operation]: The engine continues to operate without limitations after the error is detected.
Limited operation	No
Reset criteria	Yes: When the ECU power is turned off, the fault mode is released.
Remarks	

● Presumed cause of the failure or the error condition

1. Short circuit (GND) in the internal circuit of the breather heater

● Diagnosis

1. Initial diagnosis using SA-D	<ul style="list-style-type: none"> • Check the fault indication. • Check the fault indication again by turning the ECU on and off. • If DTC is detected again, inspect the breather heater and wire-harness, and replace them if necessary.
---------------------------------	--

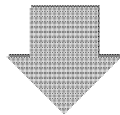

2. Failure diagnosis	<ul style="list-style-type: none"> • Check the resistance value of the breather heater. • Check the resistance value of the wire-harness. <p>* See Chapter 2 P417 for details on the diagnosis method and procedure.</p>
----------------------	--

P053C: Breather heater short circuit (VB)

P code	P053C	Name	Breather heater short circuit (VB)
SPN/FMI	3059/3		

● **DTC detection criteria**

1. Prerequisite, 2. Judgment criteria	Check points
1. The heater is energized. 2. VB short circuit (overcurrent) detected in the ECU internal circuit of the A34 terminal.	Breather heater Wire-harness

● **Actions when an error occurs**

Fault mode	[Continuous operation]: The engine continues to operate without limitations after the error is detected.
Limited operation	No
Reset criteria	Yes: When the ECU power is turned off, the fault mode is released.
Remarks	

● **Presumed cause of the failure or the error condition**

1. Short circuit (VB) in the internal circuit of the breather heater

● **Diagnosis**

1. Initial diagnosis using SA-D	<ul style="list-style-type: none"> • Check the fault indication. • Check the fault indication again by turning the ECU on and off. • If DTC is detected again, inspect the breather heater and wire-harness, and replace them if necessary.
---------------------------------	--

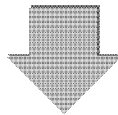

2. Failure diagnosis	<ul style="list-style-type: none"> • Check the resistance value of the breather heater. • Check the resistance value of the wire-harness. <p>* See Chapter 2 P417 for details on the diagnosis method and procedure.</p>
----------------------	--

Contact input related

■ Air cleaner switch

P1101: Air cleaner clogged alarm

P code	P1101	Name	Air cleaner clogged alarm
SPN/FMI	522323/0		

● DTC detection criteria

1. Prerequisite, 2. Judgment criteria	Check points
1. The key switch is turned on and the battery voltage is 9 V or higher. 2. The air cleaner switch is turned on for 10 seconds.	Air cleaner Wire-harness Air cleaner switch ECU

● Actions when an error occurs

	Settings of the actions during a air cleaner error	
	No	Yes
Fault mode	[Continuous operation]: The engine continues to operate without limitations after the error is detected.	[Limited operation]: The engine operation is limited.
Limited operation	No	Yes: The high idle speed or the engine output maximum injection quantity is limited. (Action differs depending on each customer's settings.)
Reset criteria	Yes: When the ECU power off is detected, the fault mode is released.	Yes: When the ECU power off is detected, the fault mode is released.
Remarks		

● Presumed cause of the failure or the error condition

1. Clogged air cleaner
2. Wiring failure of the wire-harness
 - Power short circuit of the air cleaner switch wiring
3. Air cleaner switch failure
 - Power short circuit of the air cleaner switch internal wiring
4. ECU internal circuit failure

● Diagnosis

1. Initial diagnosis using SA-D	<ul style="list-style-type: none">• Check the fault indication.• Make sure that the input signal of the air cleaner switch is correctly recognized. <p>* See Chapter 2 <i>P424</i> for details on the diagnosis method and procedure.</p>
---------------------------------	--

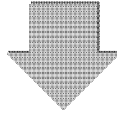

2. Engine check	<ul style="list-style-type: none">• Turn off the ECU power and stop the engine.• Check the air cleaner.• After a few moments, turn on the key switch and make sure that DTC is detected.
-----------------	--

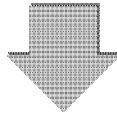

3. Failure diagnosis	<ul style="list-style-type: none">• Check the air cleaner switch system. <p>* See Chapter 2 <i>P424</i> for details on the diagnosis method and procedure.</p>
----------------------	--

■ Water separator switch

P1151: Water separator alarm

P code	P1151	Name	Water separator alarm
SPN/FMI	522329/0		

● DTC detection criteria

1. Prerequisite, 2. Judgment criteria	Check points
1. The key switch is turned on and the battery voltage is 9 V or higher. 2. The water separator is turned on for 10 seconds.	Water separator Connector Wire-harness Water separator switch ECU

● Actions when an error occurs

	Settings of the actions during a water separator error	
	No	Yes
Fault mode	[Continuous operation]: The engine continues to operate without limitations after the error is detected.	[Limited operation]: The engine operation is limited.
Limited operation	No	Yes: The high idle speed or the engine output maximum injection quantity is limited. (Action differs depending on each customer's settings.)
Reset criteria	Yes: When the ECU power off is detected, the fault mode is released.	Yes: When the ECU power off is detected, the fault mode is released.
Remarks		

● Presumed cause of the failure or the error condition

1. Water separator failure
2. Wiring failure of the wire-harness
 - Power short circuit of the water separator switch wiring
3. Water separator switch failure
 - Power short circuit of the water separator switch internal wiring
4. ECU internal circuit failure

● Diagnosis

1. Initial diagnosis using SA-D	<ul style="list-style-type: none">• Check the fault indication.• Make sure that the input signal of the water separator switch is correctly recognized. <p>* See Chapter 2 <i>P424</i> for details on the diagnosis method and procedure.</p>
---------------------------------	--

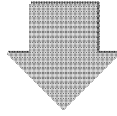

2. Engine check	<ul style="list-style-type: none">• Turn off the ECU power and stop the engine.• Check the water separator.• After a few moments, turn on the key switch and make sure that DTC is detected.
-----------------	--

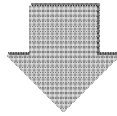

3. Failure diagnosis	<ul style="list-style-type: none">• Check the water separator switch system. <p>* See Chapter 2 <i>P424</i> for details on the diagnosis method and procedure.</p>
----------------------	--

■ Charge switch

P1562: Charge switch open circuit

P code	P1562	Name	Charge switch open circuit
SPN/FMI	167/5		

● DTC detection criteria

1. Prerequisite, 2. Judgment criteria	Check points
1. The key switch is turned on and the judgment completion criteria is incomplete. 2. The charge switch is turned off continuously for 1 sec and the judgment is formed.	Connector Wire-harness Charge switch ECU

● Actions when an error occurs

Fault mode	[Continuous operation]: The engine continues to operate without limitations after the error is detected.
Limited operation	No
Reset criteria	Yes: The fault mode is automatically released when the charge switch is turned on. Or released when the ECU power is turned off.
Remarks	

● Presumed cause of the failure or the error condition

1. Poor connection of connector
2. Wiring failure of the wire-harness
 - Disconnection or power short circuit of the charge switch wiring
3. Charge switch failure
 - Disconnection or power short circuit of the charge switch internal wiring
4. ECU internal circuit failure

● Diagnosis

1. Initial diagnosis using SA-D	<ul style="list-style-type: none">• Check the fault indication.• Make sure that the input signal of the charge switch is correctly recognized. <p>* See Chapter 2 <i>P421</i> for details on the diagnosis method and procedure.</p>
---------------------------------	---

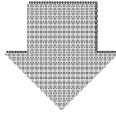

2. Connector/wiring check	<ul style="list-style-type: none">• Before beginning your work, be sure to turn off the ECU power.• Check the pin of the charge switch for deformation and cracks, the condition of the connection, and whether the retainer is loose or removed.• Make sure that the charge switch wiring is not cut or the wiring coating is not peeled.
---------------------------	--

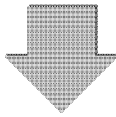

3. Failure diagnosis	<ul style="list-style-type: none">• Check the conduction of the wire-harness.• Check the operation of the charge switch. <p>* See Chapter 2 <i>P421</i> for details on the diagnosis method and procedure.</p>
----------------------	---

P1568: Charge alarm

P code	P1568	Name	Charge alarm
SPN/FMI	167/1		

● DTC detection criteria

1. Prerequisite, 2. Judgment criteria	Check points
1. No prerequisite. 2. The power switch is turned on and the charge switch is turned on and * (engine speed > 600 min ⁻¹) continues for 10 sec after the completion of the engine start. * The CAL value allows switching between “after the completion of the engine start” and “engine speed > 600 min ⁻¹ ”.	Alternator Connector Wire-harness Charge switch ECU

● Actions when an error occurs

	Setting of the charge alarm operation	
	No	Yes
Fault mode	[Continuous operation]: The engine continues to operate without limitations after the error is detected.	[Limited operation]: The engine operation is limited.
Limited operation	No	Yes: The high idle speed or the maximum injection quantity is limited. (Action differs depending on each customer's settings.)
Reset criteria	Yes: The fault mode is automatically released when the charge switch is turned off. Or released when the ECU power is turned off.	Yes: The fault mode is automatically released when the charge switch is turned off.
Remarks		

● Presumed cause of the failure or the error condition

1. Battery charge error
2. Alternator failure
3. Wiring failure of the wire-harness
 - GND short circuit of the charge switch wiring
4. Charge switch failure
 - GND short circuit of the charge switch internal wiring
5. ECU internal circuit failure

● Diagnosis

1. Initial diagnosis using SA-D	<ul style="list-style-type: none">• Check the fault indication.• Make sure that the input signal of the charge switch is correctly recognized. <p>* See Chapter 2 <i>P421</i> for details on the diagnosis method and procedure.</p>
---------------------------------	---

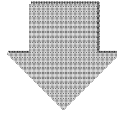

2. Engine check	<ul style="list-style-type: none">• Turn off the ECU power and stop the engine.• Check the engine charging equipment.• After checking, turn on the key switch and check for the DTC detection.
-----------------	--

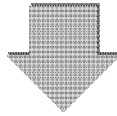

3. Failure diagnosis	<ul style="list-style-type: none">• Check the charge switch system. <p>* See Chapter 2 <i>P421</i> for details on the diagnosis method and procedure.</p>
----------------------	---

■ Oil pressure switch

P1192: Oil pressure switch open circuit

P code	P1192	Name	Oil pressure switch open circuit
SPN/FMI	100/4		

● DTC detection criteria

1. Prerequisite, 2. Judgment criteria	Check points
1. The following prerequisites should be satisfied: 1-The key switch is turned on 2-The battery voltage ≥ 9 V 3-The judgment completion criteria is incomplete 2. Judged when the oil pressure switch is turned off for one second.	Connector Wire-harness Oil pressure switch ECU

● Actions when an error occurs

Fault mode	[Continuous operation]: The engine continues to operate without limitations after the error is detected.
Limited operation	No
Reset criteria	Yes: The fault mode is automatically released when the oil pressure switch is turned on. Or released when the ECU power is turned off.
Remarks	

● Presumed cause of the failure or the error condition

1. Poor connection of connector
2. Wiring failure of the wire-harness
 - Disconnection or power short circuit of the oil pressure switch wiring
3. Oil pressure switch failure
 - Disconnection or power short circuit of the oil pressure switch internal wiring
4. ECU internal circuit failure

● Diagnosis

1. Initial diagnosis using SA-D	<ul style="list-style-type: none">• Check the fault indication.• Make sure that the input signal of the oil pressure switch is correctly recognized. <p>* See Chapter 2 <i>P421</i> for details on the diagnosis method and procedure.</p>
---------------------------------	---

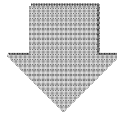

2. Connector/wiring check	<ul style="list-style-type: none">• Before beginning your work, be sure to turn off the ECU power.• Check the pin of the oil pressure switch for deformation and cracks, the condition of the connection, and whether the retainer is loose or removed.• Make sure that the oil pressure switch wiring is not cut or the wiring coating is not peeled.
---------------------------	--

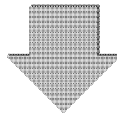

3. Failure diagnosis	<ul style="list-style-type: none">• Check the conduction of the oil pressure switch.• Check the conduction of the wire-harness.• Check the operation of the oil pressure switch. <p>* See Chapter 2 <i>P421</i> for details on the diagnosis method and procedure.</p>
----------------------	--

P1198: Low oil pressure fault alarm

P code	P1198	Name	Low oil pressure fault alarm
SPN/FMI	100/1		

● DTC detection criteria

1. Prerequisite, 2. Judgment criteria	Check points
1. The key switch is turned on * and the engine speed > 600 min ⁻¹ after the completion of the engine start and the battery voltage is 9 V or more. 2. The oil pressure switch is turned on for a certain amount of time. * The CAL value allows switching between "after the completion of the engine start" and "engine speed > 600 min ⁻¹ ".	Oil pressure equipment Wire-harness Oil pressure switch ECU

● Actions when an error occurs

	Settings of the actions during a low oil pressure alarm	
	No	Yes
Fault mode	[Continuous operation]: The engine continues to operate without limitations after the error is detected.	[Limited operation]: The engine operation is limited.
Limited operation	No	Yes: The high idle speed or the maximum injection quantity is limited. (Action differs depending on each customer's settings.)
Reset criteria	Yes: When the ECU power is turned off, the fault mode is released.	Yes: When the ECU power is turned off, the fault mode is released.
Remarks		

● Presumed cause of the failure or the error condition

1. Oil pressure low
2. Oil pressure equipment failure
3. Wiring failure of the wire-harness
 - GND short circuit of the oil pressure switch wiring
4. Oil pressure switch failure
 - GND short circuit of the oil pressure switch internal wiring
5. ECU internal circuit failure

● Diagnosis

1. Initial diagnosis using SA-D	<ul style="list-style-type: none">• Check the fault indication.• Make sure that the input signal of the oil pressure switch is correctly recognized. <p>* See Chapter 2 <i>P421</i> for details on the diagnosis method and procedure.</p>
---------------------------------	---

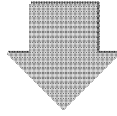

2. Engine check	<ul style="list-style-type: none">• Turn off the ECU power and stop the engine.• Check the lubrication system.• After checking, turn on the power switch and check for the DTC detection.
-----------------	---

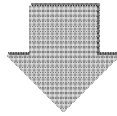

3. Failure diagnosis	<ul style="list-style-type: none">• Check the oil pressure switch system. <p>* See Chapter 2 <i>P421</i> for details on the diagnosis method and procedure.</p>
----------------------	---

After treatment control

■ DPF

P2463: Excessive PM accumulation (method C)

P code	P2463	Name	Excessive PM accumulation (method C)
SPN/FMI	522573/0		

● DTC detection criteria

1. Prerequisite, 2. Judgment criteria	Check points
1. After the completion of startup. 2. When the transition is made to the recovery regeneration mode due to the judgment of excessive PM amount (method C).	DPF intermediate temperature sensor system

● Actions when an error occurs

Fault mode	[Continuous operation]: The engine continues to operate without limitations after the error is detected.
Limited operation	No
Reset criteria	Yes: When resetting from the recovery regeneration mode, the fault mode is automatically released.
Remarks	Then this error occurs, "Backup mode" error is also detected at the same time.

Note: The lamp does not come on when this error is detected during control. However, when this error is detected, backup mode is detected at the same time. Therefore, MIL + RSL always come on. This error indicates the reasons for executing backup mode. Therefore, no FS action is executed.

● Presumed cause of the failure or the error condition

1. Insufficient regeneration capability due to the low operation load
2. Regeneration for the stationary regeneration request is not performed
3. * DPF intermediate temperature sensor system failure

* Be sure to perform the failure diagnosis for "P0420: DPF intermediate temperature sensor temperature too low" first when this error is detected at the same time. The regeneration volume may be estimated too low by "P0420: DPF intermediate temperature sensor temperature too low".

P1463: Excessive PM accumulation (method P)

P code	P1463	Name	Excessive PM accumulation (method P)
SPN/FMI	522574/0		

● **DTC detection criteria**

1. Prerequisite, 2. Judgment criteria	Check points
1. After the completion of startup. 2. When the transition is made to the recovery regeneration mode due to the judgment of excessive PM accumulation (method P).	DPF differential pressure sensor system

● **Actions when an error occurs**

Fault mode	[Continuous operation]: The engine continues to operate without limitations after the error is detected.
Limited operation	No
Reset criteria	Yes: When resetting from the recovery regeneration mode, the fault mode is automatically released.
Remarks	Then this error occurs, "Backup mode" error is also detected at the same time.

Note: The lamp does not come on when this error is detected during control. However, when this error is detected, backup mode is detected at the same time. Therefore, MIL + RSL always come on. This error indicates the reasons for executing backup mode. Therefore, no FS action is executed.

● **Presumed cause of the failure or the error condition**

1. Insufficient regeneration capability due to the low operation load
2. Regeneration for the stationary regeneration request is not performed
3. * DPF differential pressure sensor failure

* Be sure to perform the failure diagnosis for "P2452: DPF differential pressure sensor differential pressure rise error" first when this error is detected at the same time. The accumulated amount by P method may be estimated too high by "P2452: DPF differential pressure sensor differential pressure rise error".

P2458: Regeneration failure (stationary regeneration failure)

P code	P2458	Name	Regeneration failure (stationary regeneration failure)
SPN/FMI	522575/7		

● DTC detection criteria

1. Prerequisite, 2. Judgment criteria	Check points
1. No prerequisite. 2. When the transition is made to the recovery regeneration mode due to incomplete stationary regeneration within the specified time.	DPF intermediate temperature sensor system Injector DOC

● Actions when an error occurs

Fault mode	[Continuous operation]: The engine continues to operate without limitations after the error is detected.
Limited operation	No
Reset criteria	Yes: When resetting from the recovery regeneration mode, the fault mode is automatically released.
Remarks	Then this error occurs, "Backup mode" error is also detected at the same time.

● Presumed cause of the failure or the error condition

1. * DPF intermediate temperature sensor system failure
2. DOC deterioration or DOC breakage due to the external factor such as sulfur poisoning
3. Injector failure
 - Decrease in injection quantity
 - Injection timing error

* Be sure to perform the failure diagnosis for "P0420: DPF intermediate temperature sensor temperature too low" first when this error is detected at the same time. The regeneration failure may be detected by "P0420: DPF intermediate temperature sensor temperature too low".

P2459: Regeneration failure (stationary regeneration not performed)

P code	P2459	Name	Regeneration failure (stationary regeneration not performed)
SPN/FMI	522577/11		

● **DTC detection criteria**

1. Prerequisite, 2. Judgment criteria	Check points
1. No prerequisite. 2. When the transition is made to the recovery regeneration mode due to the stationary regeneration not performed in the specified time or the stationary regeneration is being requested.	Connector Wire-harness Regeneration request lamp Regeneration request switch ECU

● **Actions when an error occurs**

Fault mode	[Continuous operation]: The engine continues to operate without limitations after the error is detected.
Limited operation	No
Reset criteria	Yes: When resetting from the recovery regeneration mode, the fault mode is automatically released.
Remarks	Then this error occurs, "Backup mode" error is also detected at the same time.

● **Presumed cause of the failure or the error condition**

1. Poor connection of connector
2. Wiring failure of the wire-harness
 - Regeneration for the stationary regeneration request is not performed
 - Oversight due to the regeneration request lamp failure
 - Regeneration not performed due to the regeneration request switch failure
3. When the engine speed is dropped to low idling during regeneration and abandoned
4. ECU internal circuit failure

P1426: DPF intermediate temperature sensor temperature rise error (post-injection failure)

P code	P1426	Name	DPF intermediate temperature sensor temperature rise error (post-injection failure)
SPN/FMI	3250/0		

● **DTC detection criteria**

1. Prerequisite, 2. Judgment criteria	Check points
1. Regeneration is active. 2. DPF intermediate temperature is 750 °C or higher for a given length of time (30 seconds).	

● **Actions when an error occurs**

Fault mode	[Limited operation]: The engine operation is limited.
Limited operation	Yes: 1. Default <ul style="list-style-type: none"> • The engine stops when a sensor abnormality occurs. • No delayed operation. • EGR fully opens. • DPF regeneration stops. 2. Option <ul style="list-style-type: none"> • Rated power decreases. • The maximum torque is limited to 85%. • The engine speed is limited to the [maximum torque speed +200 min⁻¹]. • EGR fully closes. • DPF regeneration stops. • Rated output of the engine is reduced further after 15 min. • The maximum engine torque is limited to 50%.
Reset criteria	Yes: When the ECU power is turned off, the fault mode is released.
Remarks	

Note: If this error occurs, incorrect injection quantity is expected. If the exhaust temperature excessively rises, it is dangerous. Therefore, "Lv1: Engine stop" is set to FS action by default. When stopping the engine should be avoided due to characteristics of the driven machine, conventional FS action (Lv2) can be selected (no engine stop).

● **Presumed cause of the failure or the error condition**

1. Poor connection of connector
2. Wiring failure of the wire-harness
3. DPF intermediate temperature sensor system failure
4. ECU internal circuit failure
5. Injector failure
 - Increase in injection quantity
 - Injection timing error

■ DPF OP interface

P242F: Ash cleaning request 1

P code	P242F	Name	Ash cleaning request 1
SPN/FMI	3720/16		

● DTC detection criteria

1. Prerequisite, 2. Judgment criteria	Check points
1. No prerequisite. 2. The ash accumulation density is greater than or equal to 50 g/L, and less than 60 g/L.	DPF ECU

● Actions when an error occurs

Fault mode	[Limited operation]: The engine operation is limited.
Limited operation	Yes: The maximum engine torque is limited to 85%.
Reset criteria	Yes: The fault mode is automatically released when the ash cleaning request is not detected.
Remarks	

● Presumed cause of the failure or the error condition

1. ECU internal circuit failure
2. * Increase in the actual differential pressure of the soot filter
 - Ash is accumulated

* There are cases in which the differential pressure does not rise drastically and the actual ash accumulation is little. When this error occurs, it is highly possible that the engine has not been used for a long time. In such a case, it is required to perform the DPF maintenance.

P1420: Ash cleaning request 2

P code	P1420	Name	Ash cleaning request 2
SPN/FMI	3720/0		

● DTC detection criteria

1. Prerequisite, 2. Judgment criteria	Check points
1. No prerequisite. 2. Ash accumulation density is 60 g/L or more.	DPF ECU

● Actions when an error occurs

Fault mode	[Limited operation]: The engine operation is limited.
Limited operation	Yes: • When sensor error occurs, rated output of the engine is reduced immediately. • The maximum engine torque is limited to 85%. • Rated output of the engine is reduced further after 120 min. • The maximum engine torque is limited to 50%.
Reset criteria	Yes: The fault mode is automatically released when the ash cleaning request is not detected.
Remarks	

● Presumed cause of the failure or the error condition

1. ECU internal circuit failure
2. * Increase in the actual differential pressure of the soot filter
 - Ash is accumulated

* There are cases in which the differential pressure does not rise drastically and the actual ash accumulation is little. When this error occurs, it is highly possible that the engine has not been used for a long time. In such a case, it is required to perform the DPF maintenance.

P1421: Stationary regeneration standby

P code	P1421	Name	Stationary regeneration standby
SPN/FMI	3719/16		

● **DTC detection criteria**

1. Prerequisite, 2. Judgment criteria	Check points
1. No prerequisite. 2. The transition is made to the stationary regeneration mode for the factors except for the SW/CAN direction from the outside during the stationary regeneration.	Injector ECU DOC Piping

● **Actions when an error occurs**

Fault mode	[Limited operation]: The engine operation is limited.
Limited operation	Yes: • When sensor error occurs, rated output of the engine is reduced immediately. • The maximum engine torque is limited to 85%. • Rated output of the engine is reduced further after 120 min. • The maximum engine torque is limited to 50%.
Reset criteria	Yes: The fault mode is automatically released when the stationary regeneration standby is not detected.
Remarks	

● **Presumed cause of the failure or the error condition**

1. Insufficient regeneration capability due to the low operation load
2. Because the conditions of reset regeneration and regeneration forbidden switch turned on are continued for a given period of time
3. ECU internal circuit failure
4. DOC deterioration due to the external factor such as sulfur poisoning
 - Increase in activated temperature
5. Blow-by of combustion gas
 - Catalytic damage
 - Piping damage in the passage to DOC
6. Injector failure
 - Decrease in injection quantity
 - Injection timing error

P1424: Backup mode

P code	P1424	Name	Backup mode
SPN/FMI	3719/0		

● DTC detection criteria

1. Prerequisite, 2. Judgment criteria	Check points
1. No prerequisite. 2. The transition is made to the recovery regeneration mode and while the recovery regeneration is not performed.	Injector ECU DOC Piping

● Actions when an error occurs

Fault mode	[Limited operation]: The engine operation is limited.
Limited operation	Yes: <ul style="list-style-type: none"> • When sensor error occurs, rated output of the engine is reduced immediately. • The maximum engine torque is limited to 85%. • The engine speed is limited to the [maximum torque speed +200 min⁻¹]. • EGR fully closes. • Rated output of the engine is reduced further after 15 min. • The maximum engine torque is limited to 50%. • The engine speed is limited to the [maximum torque speed +200 min⁻¹].
Reset criteria	Yes: The fault mode is automatically released when the backup mode is not detected.
Remarks	

● Presumed cause of the failure or the error condition

1. It is abandoned for a given period of time in the stationary regeneration standby emergency mode
2. ECU internal circuit failure
3. DOC deterioration due to the external factor such as sulfur poisoning
 - Increase in activated temperature
4. Blow-by of combustion gas
 - Catalytic damage
 - Piping damage in the passage to DOC
5. Injector failure
 - Decrease in injection quantity
 - Injection timing error

Note: When this error is detected, either "Excessive PM accumulation (method C)", "Excessive PM accumulation (method P)", "Regeneration failure (stationary regeneration failure)", or "Regeneration failure (stationary regeneration not performed)" is detected at the same time. When recovery regeneration fails, "Recovery regeneration failure" or "Recovery regeneration is inhibited" may be detected. Be sure to perform the failure diagnosis for the respective part.

P1425: Reset regeneration is inhibited

P code	P1425	Name	Reset regeneration is inhibited
SPN/FMI	3695/14		

● DTC detection criteria

1. Prerequisite, 2. Judgment criteria	Check points
1. No prerequisite. 2. The post injection is inhibited by prohibition SW of DPF regeneration when the operation transmitted to the reset regeneration mode.	Regeneration inhibit switch (including CAN control)

● Actions when an error occurs

Fault mode	[Continuous operation]: Engine control is not obstructed.
Limited operation	No
Reset criteria	Yes: Error determination conditions are not met.
Remarks	This function only applies to special models.

● Presumed cause of the failure or the error condition

The mode is reset regeneration, but the regeneration is prohibited by the regeneration Inhibit switch (including CAN control) and the regeneration cannot be performed.

P1445: Recovery regeneration failure

P code	P1445	Name	Recovery regeneration failure
SPN/FMI	3719/9		

● DTC detection criteria

1. Prerequisite, 2. Judgment criteria	Check points
1. No prerequisite. 2. The recovery regeneration fails.	DPF intermediate temperature sensor system Injector DOC

● Actions when an error occurs

Fault mode	[Engine stop]: The engine operation stops.
Limited operation	Yes: Fuel injection stops.
Reset criteria	Yes: When the ECU power is turned off, the fault mode is released.
Remarks	

● Presumed cause of the failure or the error condition

1. * DPF intermediate temperature sensor system failure
2. DOC deterioration or DOC breakage due to the external factor such as sulfur poisoning
3. Injector failure
 - Decrease in injection quantity
 - Injection timing error

* There are cases in which this error occurs due to the regeneration failure judgment caused by "P0420: DPF intermediate temperature sensor temperature too low". When this is detected at the same time, be sure to perform the failure diagnosis for "P0420: DPF intermediate temperature sensor temperature too low" in advance.

P1446: Recovery regeneration is inhibited

P code	P1446	Name	Recovery regeneration is inhibited
SPN/FMI	3719/7		

● **DTC detection criteria**

1. Prerequisite, 2. Judgment criteria	Check points
1. No prerequisite. 2. When recovery regeneration occurs, either of the following conditions is true: <ul style="list-style-type: none"> • “DPF PM accumulation density (C method)” is greater than or equal to the threshold value of “PM accumulation density (for prohibition determination of recovery regeneration)” and it continues for the time same to the “prohibition determining time of recovery regeneration (C method)” • “DPF PM accumulation density (P method)” is greater than or equal to the threshold value of “PM accumulation density (for prohibition determination of recovery regeneration)” and it continues for the time more than the “prohibition determining time of recovery regeneration (P method)” 	SF

● **Actions when an error occurs**

Fault mode	[Engine stop]: The engine operation stops.
Limited operation	Yes: Fuel injection stops.
Reset criteria	Yes: When the ECU power is turned off, the fault mode is released.
Remarks	

● **Presumed cause of the failure or the error condition**

The PM is overaccumulated and the recovery regeneration cannot be performed.

Others

■ Overspeed

P0219: Overspeed

P code	P0219	Name	Overspeed
SPN/FMI	190/0		

● DTC detection criteria

1. Prerequisite, 2. Judgment criteria	Check points
1. No prerequisite. 2. The engine speed is greater than the following threshold value: YMR standard: <ul style="list-style-type: none"> • Maximum idling speed + 600 min⁻¹ JD exclusive: <ul style="list-style-type: none"> • NV2 engine: 3,800 min⁻¹ • NV3 engine: 3,300 min⁻¹ 	Crankshaft speed sensor Camshaft speed sensor Injector ECU

● Actions when an error occurs

Fault mode	[Engine stop]: The engine operation stops.
Limited operation	Yes: Fuel injection stops.
Reset criteria	Yes: When the ECU power off is detected, the fault mode is released.
Remarks	Detected speed is different in some engines with special specifications.

● Presumed cause of the failure or the error condition

1. Crankshaft speed sensor failure
 - Temporary failure caused by external factors such as radio waves
2. Camshaft speed sensor failure
 - Temporary failure caused by external factors such as radio waves
3. ECU internal circuit failure
4. Injector failure

● Diagnosis

1. Initial diagnosis using SA-D	<ul style="list-style-type: none"> • Check the fault indication. • Switch the ECU power from ON to OFF to check the fault indication again. * See Chapter 2 P472 for details on the diagnosis method and procedure.
---------------------------------	---

Method and Procedure of Failure Diagnosis

Description

● Related DTC

The related DTCs are listed.

P code	P code	Name	Error name
SPN/FMI	SPM/FMI		

● Workflow

The workflow for failure diagnosis is listed.

● Wire diagram

The wire diagram for the parts related to faults is listed.

● Work description

The corrective action and procedure for failure diagnosis is listed.

■ ECU pin layout diagram

Coupler on the wire-harness side
(fitting side)

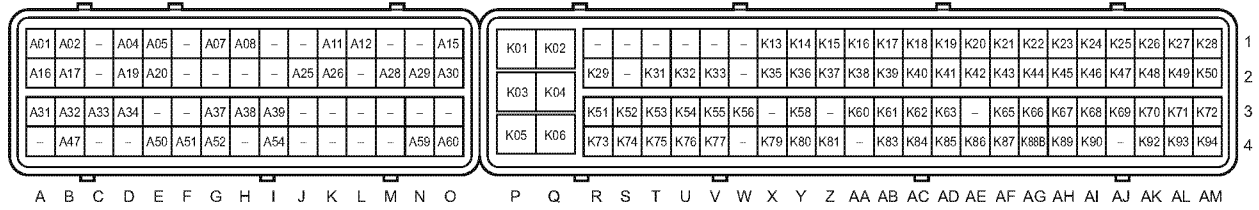

Coupler on the ECU side
(fitting side)

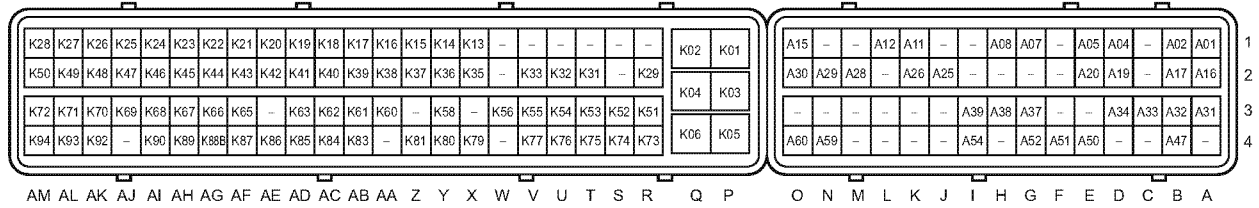

044375-00E100

No.	Terminal function name	Code
A01	1-A Injector L	INJL1 - 4
A02	1-B Injector L	INJL1 - 4
A04	1-D SCV H	MPROP-H
A05	1-E SCV L	HPPSOL
A07	1-G Sensor 5 V	5VS
A08	1-H Sensor 5 V	5VS
A11	1-K FO temperature sensor	TFO
A12	1-L DPF hi-side pressure sensor	PDPFH
A15	1-O FO temperature sensor	REOP2
A16	2-A Injector L	INJL1 - 4
A17	2-B Injector L	INJL1 - 4
A19	2-D Intake valve motor	IVDCM-H, L
A20	2-E Intake valve motor	IVDCM-H, L
A25	2-J Analog GND	A-GND
A26	2-K Rail pressure	PRAIL
A28	2-M CW temperature sensor	TW
A29	2-N Analog GND	A-GND
A30	2-O External 12 V	UB5
A31	3-A Injector H	INJH1 - 4
A32	3-B Injector H	INJH1 - 4
A33	3-C Injector H	INJH1 - 4
A34	3-D Reserve	REOP1
A37	3-G Cam speed	CMSPD
A38	3-H Analog GND	A-GND

No.	Terminal function name	Code
A54	4-I Crank speed	CKSPD
A59	4-N intake manifold temperature sensor	TIAIR
A60	4-O External 12 V	UB2
K01	1-P VB	VB
K02	1-Q ECU GND	GND
K03	2-P VB	VB
K04	2-Q ECU GND	GND
K05	3-P VB	VB
K06	3-Q ECU GND	GND
K13	1-X Speed selection enable	APP-IP6
K14	1-Y Starter permission 1	APP-IP9
K15	1-Z LO pressure switch	LOPSW
K16	1-AA Speed 2	APP-IP4
K17	1-AB Hi-idle speed select	APP-IP8
K18	1-AC DPF regeneration request	REGSW
K19	1-AD Speed 1	APP-IP3
K20	1-AE Intake valve sensor	IVPS
K21	1-AF Analog GND	A-GND
K22	1-AG Accelerator pedal	PDLSPW
K23	1-AH Sensor 5 V	5VS
K24	1-AI Sensor 5 V	5VS
K25	1-AJ DPF regeneration request	DPF-M1
K26	1-AK Iso-chronous lamp	APP-OP2
K27	1-AL DPF regeneration inhibit lamp	DPF-M2

Method and Procedure of Failure Diagnosis

No.	Terminal function name	Code
A39	3-I Crank speed	CKSPD
A47	4-B Injector H	INJH1 - 4
A50	4-E External 12 V	UB3
A51	4-F Analog GND	A-GND
A52	4-G Analog GND	A-GND
K35	2-X Key switch start	STARTSW
K36	2-Y Reserve analog	REAN
K37	2-Z Droop	APP-IP1
K38	2-AA Starter permission 2	APP-IP2
K39	2-AB EGR low-side pressure sensor	PEGRL
K40	2-AC Water separator sensor	WSSW
K41	2-AD Air cleaner sensor	ACLSW
K42	2-AE Hi-idle limit enable	APP-IP5
K43	2-AF Sensor 5 V	5VS
K44	2-AG Sensor 5 V	5VS
K45	2-AH Sensor 5 V	5VS
K46	2-AI Sensor 5 V	5VS
K47	2-AJ Load ratio monitor	LOAD-M
K48	2-AK Red engine stop lamp	REOP4
K49	2-AL CWT warning lamp	OVHT-LMP
K50	2-AM Pre-heat lamp	PREHT-LMP
K51	3-R External 12 V	UB3
K52	3-S Analog GND	A-GND
K53	3-T CAN-L2	CAN2L
K54	3-U CAN-H1	CAN1H
K55	3-V Analog GND	A-GND
K56	3-W Exhaust gas temperature sensor	TEXMN
K58	3-Y Accelerator sensor 3	APS3
K60	3-AA Analog GND	A-GND
K61	3-AB Accelerator sensor 1	APS1
K62	3-AC Analog GND	A-GND
K63	3-AD DPF differential pressure sensor	PDPF
K65	3-AF Analog GND	D-GND
K66	3-AG Alternator L terminal	CHGSW

No.	Terminal function name	Code
K28	1-AM Starter relay	STR-RLY
K29	2-R External 12 V	UB2
K31	2-T DPF regeneration inhibit	REGMSW
K32	2-U Engine stop 1	SHUDNSW
K33	2-V EGR gas temperature sensor	TEGR
K67	3-AH Engine stop 2	APP-IP7
K68	3-AI External 12 V	UB2
K69	3-AJ EGT lamp	DPF-M3
K70	3-AK Starting aid relay	SAID-RLY
K71	3-AL DPF regeneration acknowledge lamp	DPF-M4
K72	3-AM Amber warning lamp	REOP3
K73	4-R External 12 V	UB5
K74	4-S Analog GND	A-GND
K75	4-T CAN-H2	CAN2H
K76	4-U CAN-L1	CAN1L
K77	4-V Analog GND	A-GND
K79	4-X Fresh air temperature sensor	TFAIR
K80	4-Y DPF inside temperature sensor	TDPFM
K81	4-Z DPF inlet temperature sensor	TDPFI
K83	4-AB Accelerator sensor 2	APS2
K84	4-AC Analog GND	A-GND
K85	4-AD EGR hi-side pressure sensor	PEGR
K86	4-AE Regeneration interlock	WDSBSW
K87	4-AF Analog GND	D-GND
K88B	4-AG Key switch on	IGNSW
K89	4-AH External 12 V	UB3
K90	4-AI External 12 V	UB3
K92	4-AK Failure lamp	FAIL-LMP
K93	4-AL Speed selection lamp	APP-OP1
K94	4-AM Speed monitor	NRPM-M

■ How to use the Tier 4 checker harness

When you perform the ECU related failure diagnosis, use the Tier 4 checker harness to measure the voltage value. Therefore, remove the ECU and the machine wire-harness and connect the Tier 4 checker harness between the ECU and the machine wire-harness prior to the failure diagnosis.

Note • For the details of the failure diagnosis on each part, refer to the following description.

- Use the circuit tester to measure the voltage value in accordance with the following table as a reference.

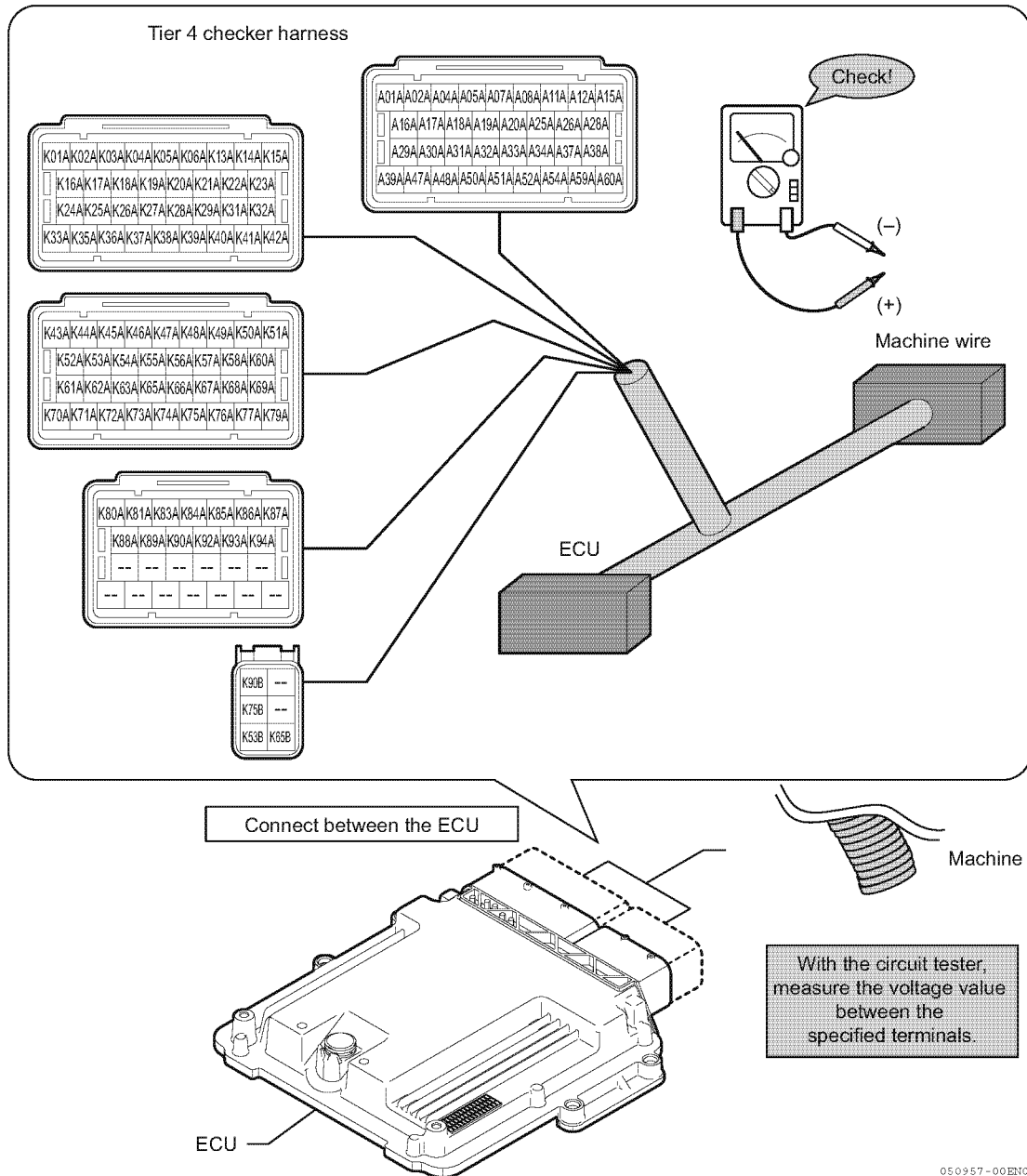

Sensor related

■ Crankshaft speed sensor

● Related DTC

P code	SPN/FMI	Name
P0336	522400/2	Crankshaft signal error
P0337	522400/5	No signal from crankshaft
P0008	523249/5	No signal on both crankshaft and camshaft speed sensor

● Workflow

Note: See "Work description" for work details. Go to "SA-D Operation Manual" for the SA-D operation.

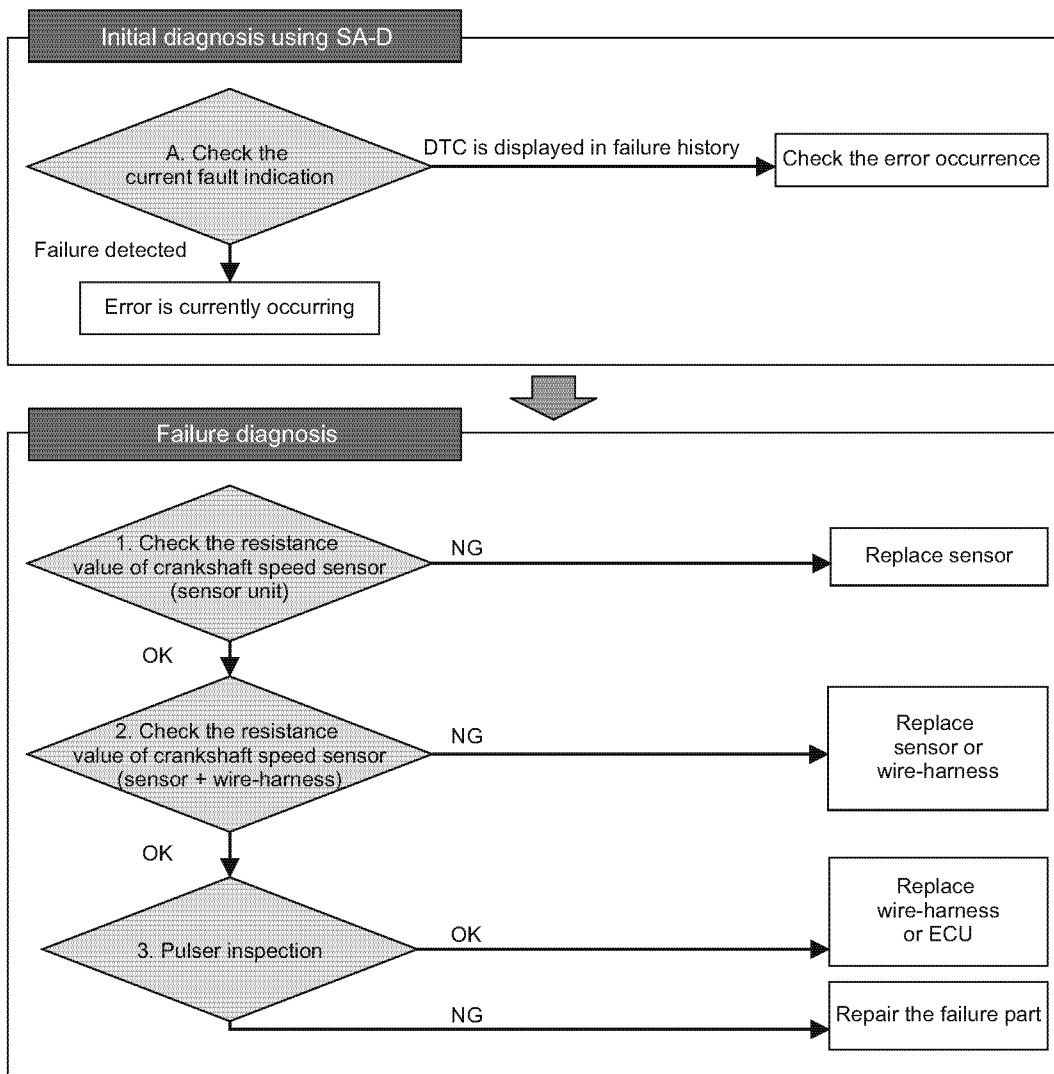

045705-00EN00

● Wire diagram

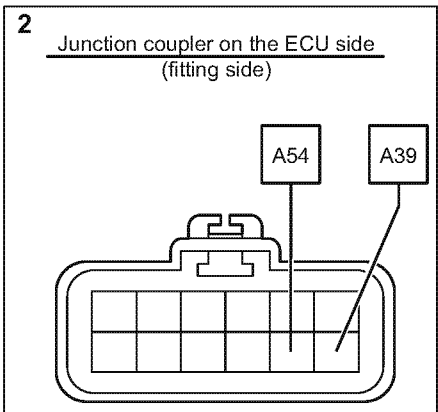
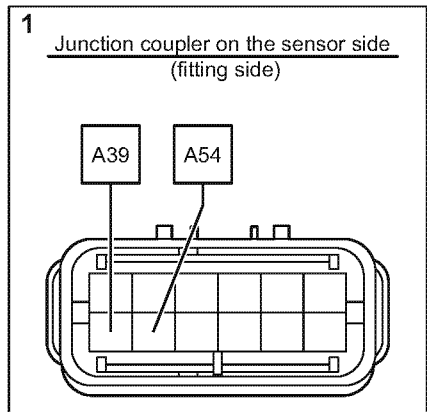
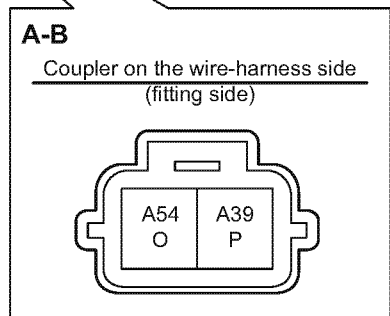
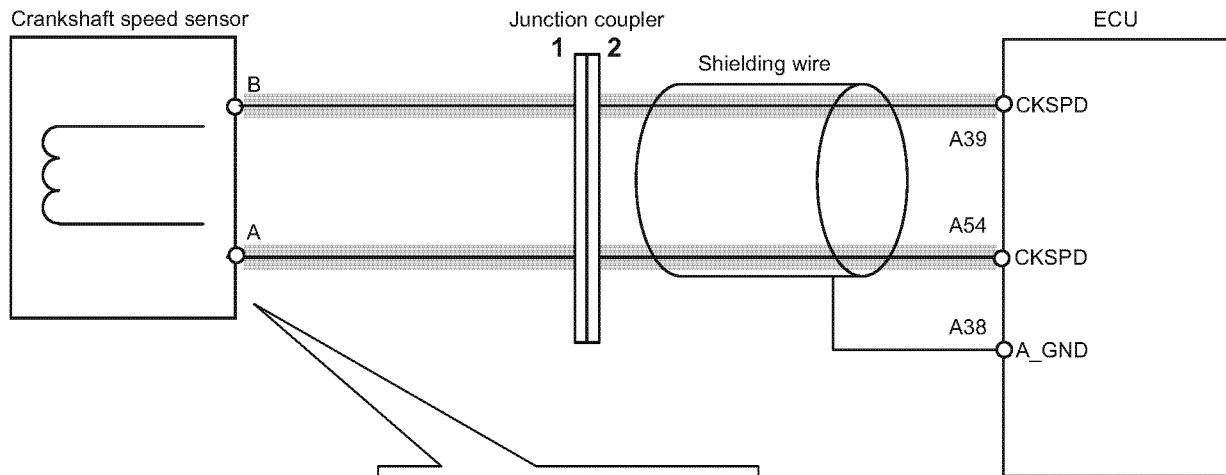

045706-00EN00

Note: See P325 for the ECU pin layout.

● **Work description**

1. Checking the resistance values of the crankshaft speed sensor

- 1-Remove the crankshaft speed sensor from the wire-harness.
- 2-Using a circuit tester, measure the resistance value between crankshaft speed sensors A and B.

Reference: Resistance value between crankshaft speed sensor terminals

Terminal	Specifications
Sensor A - B	1050 Ω (Error 10%)

NG	Replace the crankshaft speed sensor.
OK	Go to "Checking the resistance values of the crankshaft speed sensor (sensor and wire-harness)".

2. Checking the resistance values of the crankshaft speed sensor (sensor and wire-harness)

- 1-Remove the ECU from the wire-harness while the crankshaft speed sensor and the wire-harness are connected.
- 2-Using a circuit tester, measure the resistance value between ECU connector terminals A39 - A54 on the wire-harness side.

Note: See the above "Reference: Resistance value between crankshaft speed sensor terminals".

NG	<ul style="list-style-type: none"> • The coupler between the sensor and the wire-harness may be defective. Replace the sensor. • Replace the wire-harness.
OK	Go to "Pulser inspection".

3. Pulser inspection

- 1-Check the pulser for cracks, pieces of metal, distortion, etc.

NG	Repair the failure part.
OK	<ul style="list-style-type: none"> • The coupler between the ECU and the wire-harness may be defective. Replace the wire-harness. • Replace the ECU.

■ Camshaft speed sensor

● Related DTC

P code	SPN/FMI	Name
P0341	522401/2	Camshaft signal error
P0342	522401/5	No signal from camshaft
P0008	523249/5	No signal on both crankshaft and camshaft speed sensor

● Workflow

Note: See "Work description" for work details. Go to "SA-D Operation Manual" for the SA-D operation.

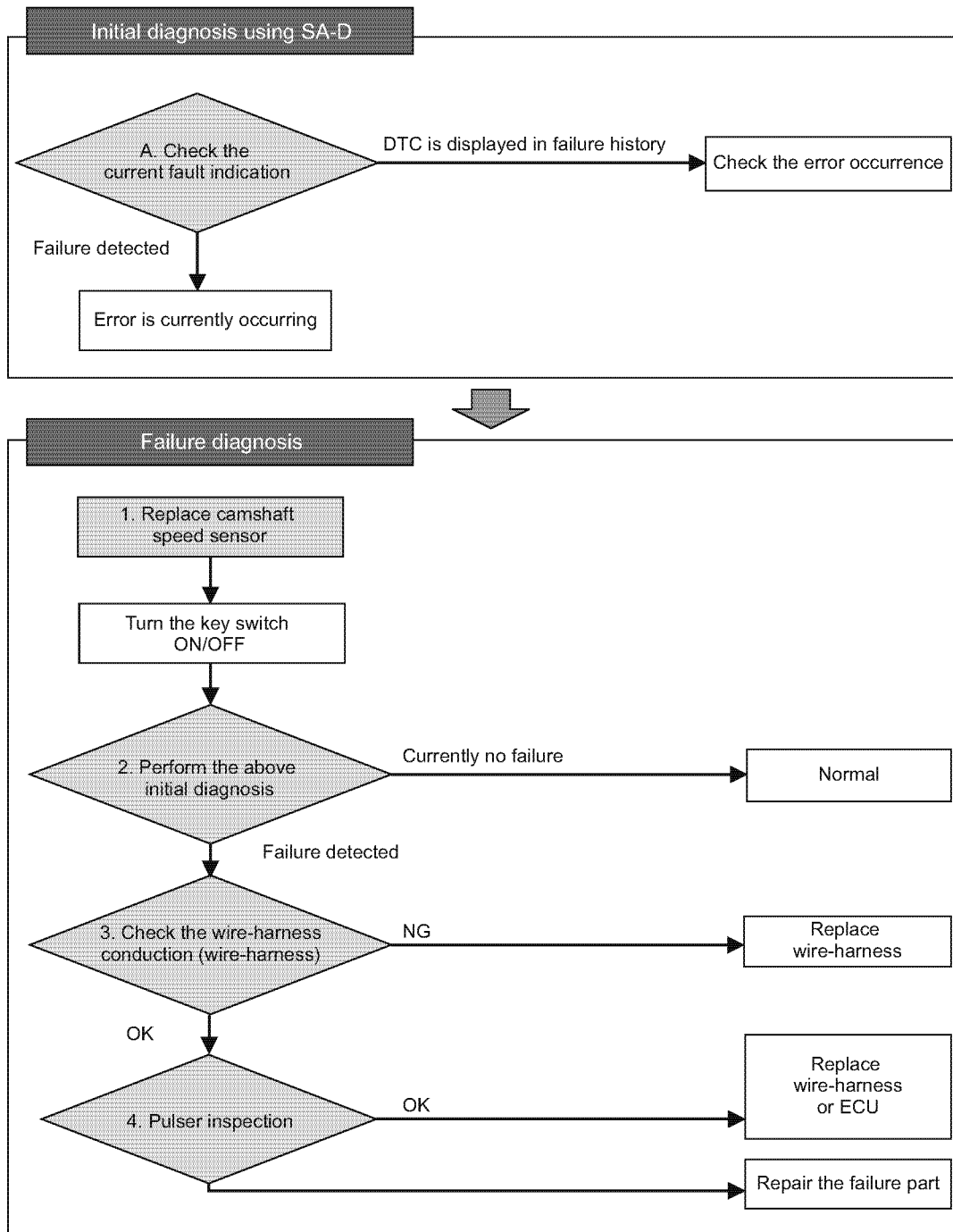

043566-02EN01

● Wire diagram

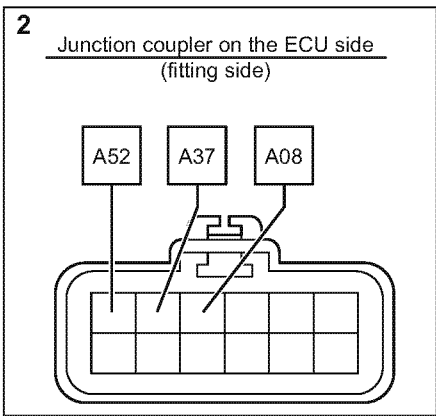
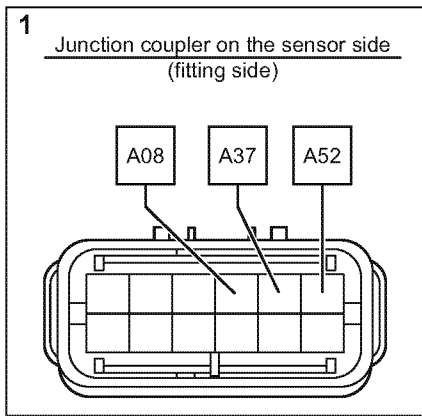
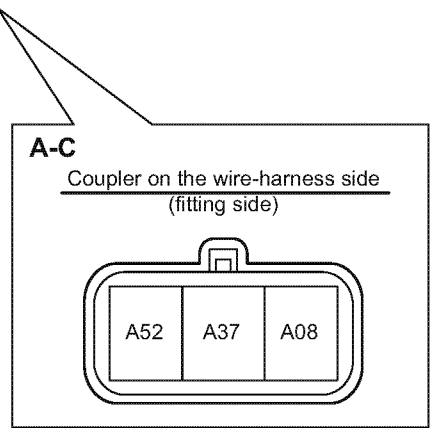
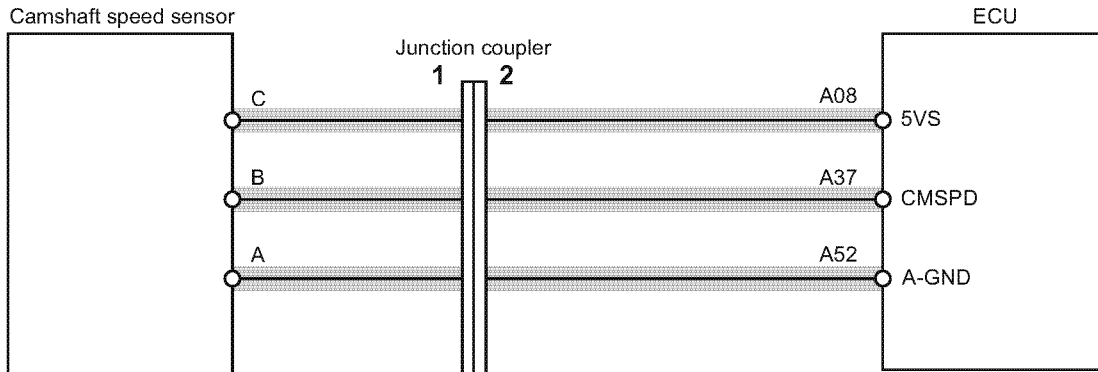

Note: See P325 for the ECU pin layout.

045708-00EN00

● **Work description**

1. Replacing the camshaft speed sensor

1- Remove the camshaft speed sensor from the wire-harness and replace it.

2. Operation using SA-D

1- Turn off the key switch, turn on the key switch again, and start the engine.

2- Connect the SA-D and check the current fault indication to see whether an error is detected.

No	Normal
Yes	Go to "Checking the wire-harness conduction".

3. Checking the wire-harness conduction

1- Remove the wire-harness from the camshaft speed sensor and the ECU. However, connect the junction coupler.

2- While referring to the P325 "ECU pin layout diagram", check the conduction of the wire-harness between terminals 1 and 2 in the chart below.

Reference: Pattern for checking the conduction of the camshaft speed sensor 1

Terminal 1 (Wire-harness connector on ECU side)	Terminal 2 (Wire-harness connector on camshaft speed sensor side)	Conduction	State
A08	Camshaft speed sensor terminal C	No	NG: Error
		Yes	OK: Normal
A37	Camshaft speed sensor terminal B	No	No
		Yes	Yes
A52	Camshaft speed sensor terminal A	No	No
		Yes	Yes

Reference: Pattern for checking the conduction of the camshaft speed sensor 2

Terminal 1 (Wire-harness connector on ECU side)	Terminal 2 (Wire-harness connector on ECU side)	Conduction	State
A08	All other terminals	Yes	NG: Error
		No	OK: Normal
A37		Yes	NG: Error
		No	OK: Normal
A52		Yes	NG: Error
		No	OK: Normal

NG	Wire-harness disconnection or short circuit. Replace the wire-harness.
OK	Go to "Pulser inspection".

4. Pulser inspection

1- Check the pulser for cracks, pieces of metal, distortion, etc.

NG	Repair the failure part.
OK	<ul style="list-style-type: none"> • Replace the wire-harness. • Replace the ECU.

■ Accelerator sensor

● Related DTC

P code	SPN/FMI	Name
P0123	91/3	Accelerator sensor 1 error (voltage high)
P0122	91/4	Accelerator sensor 1 error (voltage low)
P0223	28/3	Accelerator sensor 2 error (voltage high)
P0222	28/4	Accelerator sensor 2 error (voltage low)
P0228	29/3	Accelerator sensor 3 error (voltage high)
P0227	29/4	Accelerator sensor 3 error (voltage low)

● Workflow

Note: See "Work description" for work details. Go to "SA-D Operation Manual" for the SA-D operation.

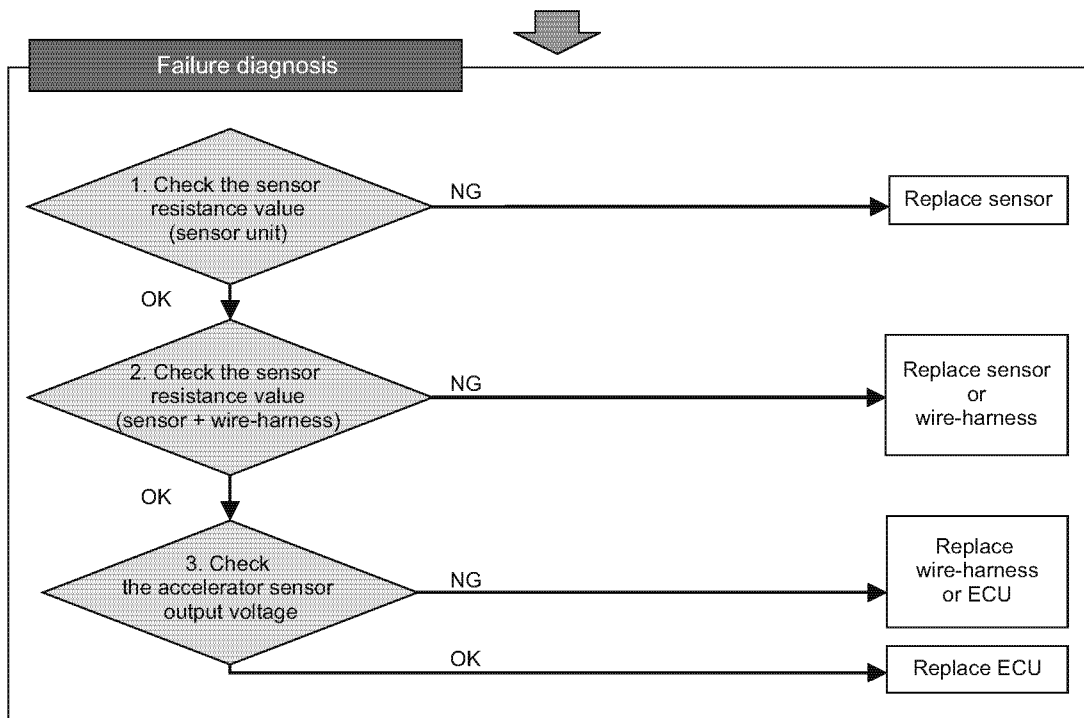
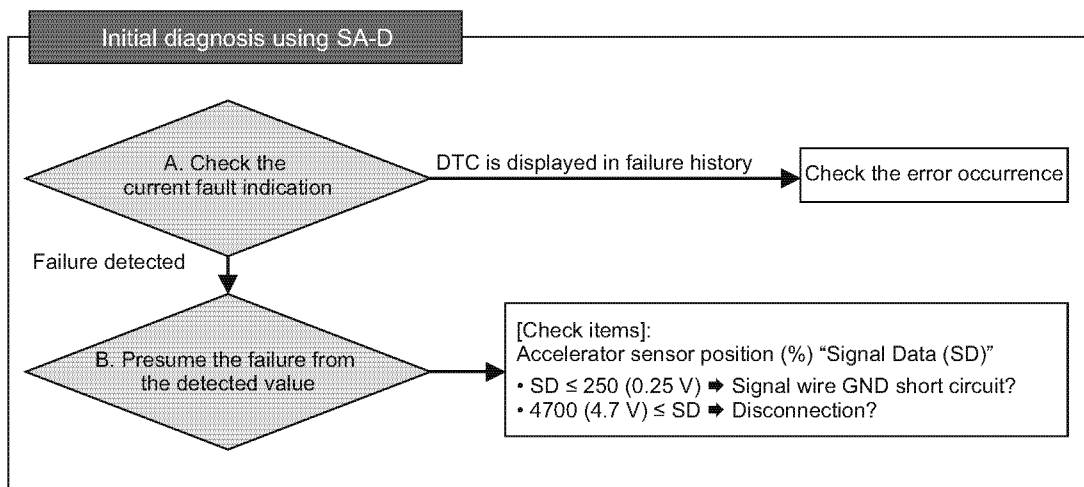

043556-02EN01

● Wiring diagram

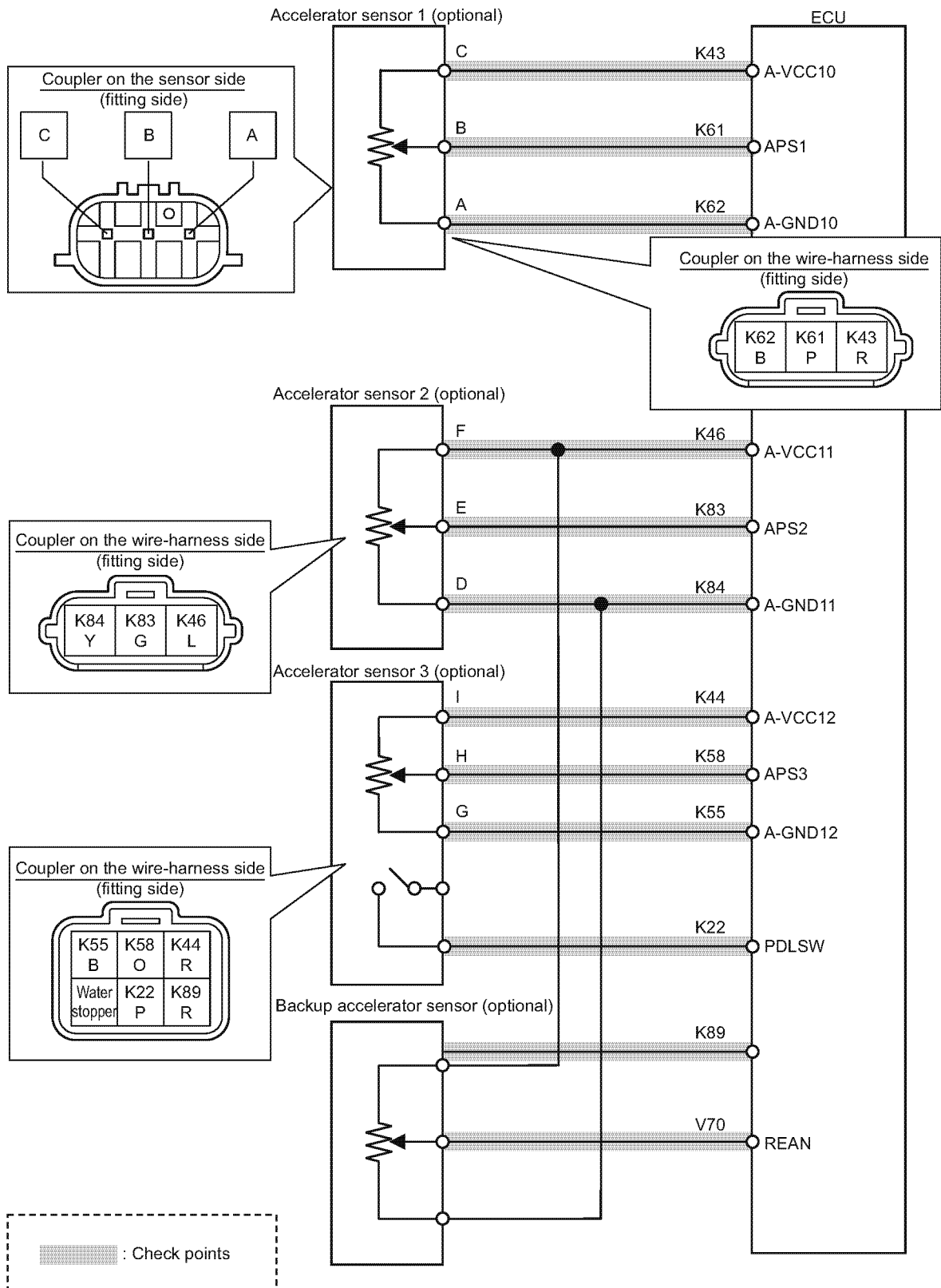

043363-01EN02

Note: See P325 for the ECU pin layout.

● **Work description**

1. Checking the sensor resistance value (sensor unit)

- Between the accelerator sensor 1 terminals A and C (accelerator sensor 2 terminals D and F) (accelerator sensor 3 terminals G and I) (overall resistance value)

1- Remove the accelerator sensor from the wire-harness.

2- Using a circuit tester, measure the resistance value between sensor terminals A and C (D and F) (G and I) (overall resistance value).

Reference: YANMAR standard accelerator sensor overall resistance value

Terminal	Specifications
Sensor A to C (sensor D to F)	$5 \pm 1.5 \text{ k}\Omega$

NG	Replace the accelerator sensor.
OK	Go to "Between accelerator sensor terminals A and B (D and E) (G and H)".

- Between accelerator sensor terminals A and B (D and E) (G and H)

1- Using a circuit tester, measure the resistance value between accelerator sensor terminals A and B (D and E) (G and H).

2- Move the accelerator throttle, and check if the resistance value between accelerator sensor terminals A and B fluctuates.

NG	Replace the accelerator sensor.
OK	Go to "Checking the sensor resistance value (sensor and wire-harness)".

2. Checking the sensor resistance value (sensor and wire-harness)

- Between wire-harnesses K43 and K62 (K46 and K84) (K44 and K55) (overall resistance value)

1- Connect the accelerator sensor and wire-harness then remove the ECU from the wire-harness.

2- Using a circuit tester, measure the resistance value (overall resistance value) between ECU connectors K43 and K62 (K46 and K84) (K44 and K55) on the wire-harness side.

Note: See above "Reference: YANMAR standard accelerator sensor overall resistance value".

NG	<ul style="list-style-type: none"> • The coupler between the sensor and the wire-harness may be defective. Replace the sensor. • Replace the wire-harness.
OK	Go to "Between wire-harnesses K61 and K62 (K83 and K84) (K58 and K55)".

- Between wire-harnesses K61 and K62 (K83 and K84) (K58 and K55)

1- Using a circuit tester, measure the resistance value between ECU connectors K61 and K62 (K83 and K84) (K58 and K55).

2- Move the accelerator throttle, and check if the resistance value between ECU connectors K61 and K62 (K83 and K84) (K58 and K55) fluctuates.

NG	<ul style="list-style-type: none"> • The coupler between the sensor and the wire-harness may be defective. Replace the sensor. • Replace the wire-harness.
OK	Go to "Checking the accelerator sensor output voltage".

■ Intake throttle position sensor

● Related DTC

P code	SPN/FMI	Name
P02E8	51/4	Intake throttle position sensor error (voltage low)
P02E9	51/3	Intake throttle position sensor error (voltage high)

● Workflow

Note: See "Work description" for work details. Go to "SA-D Operation Manual" for the SA-D operation.

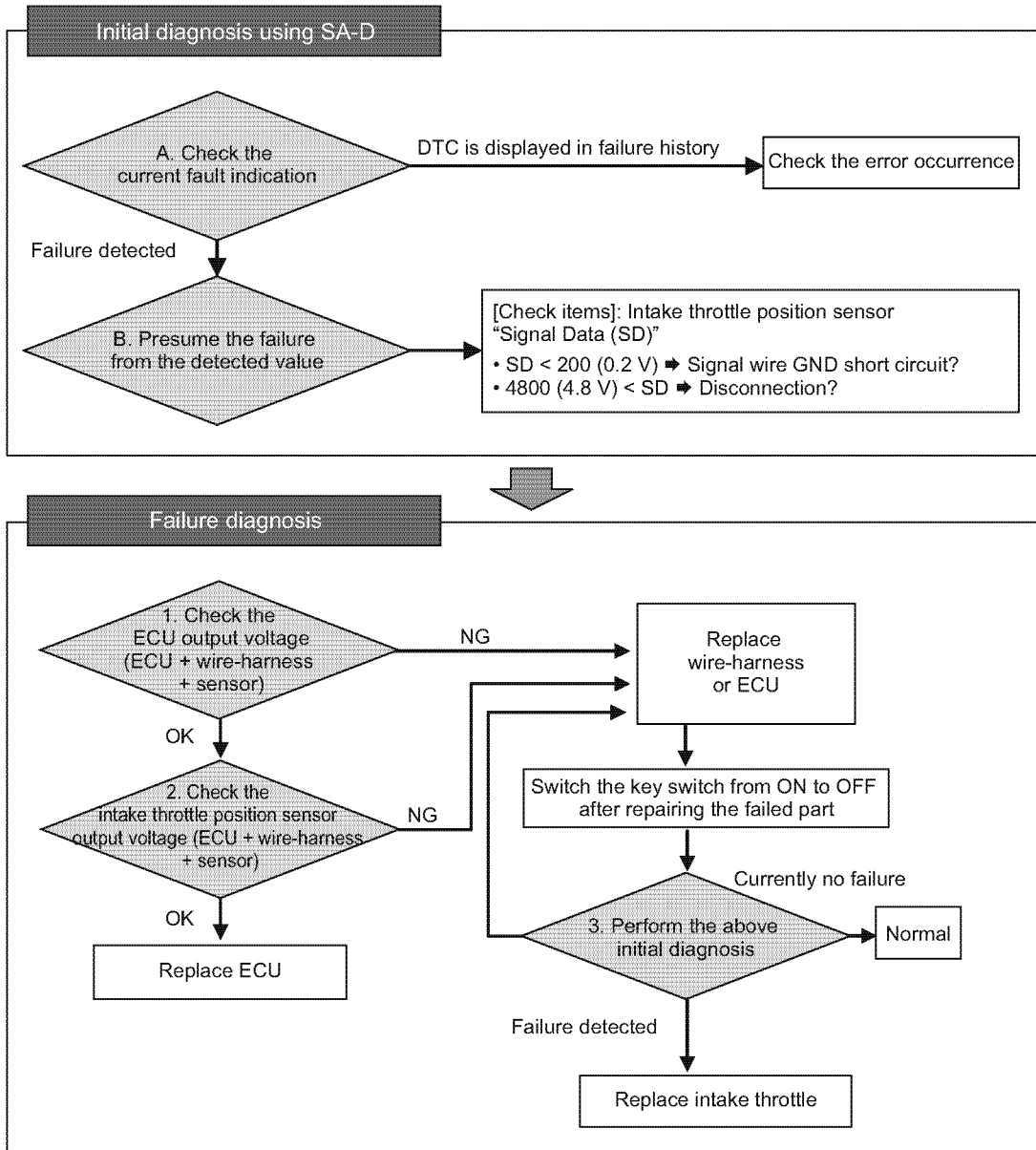

050230-01EN01

● Wiring diagram

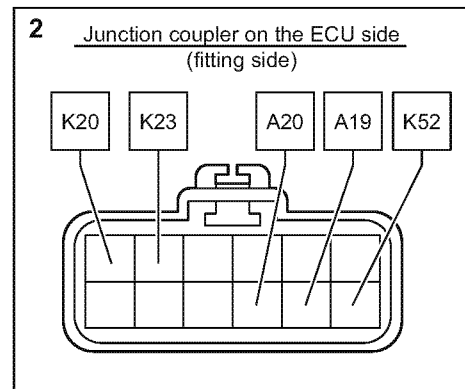
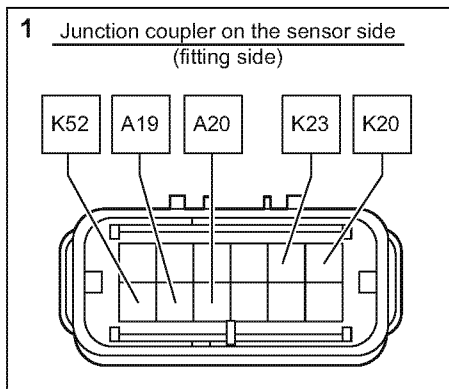
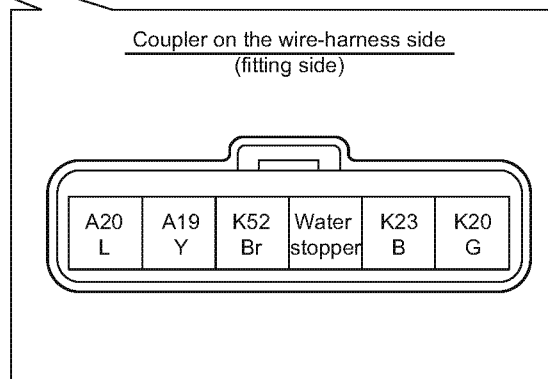
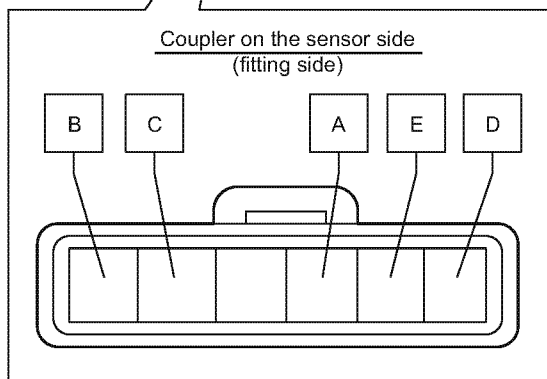
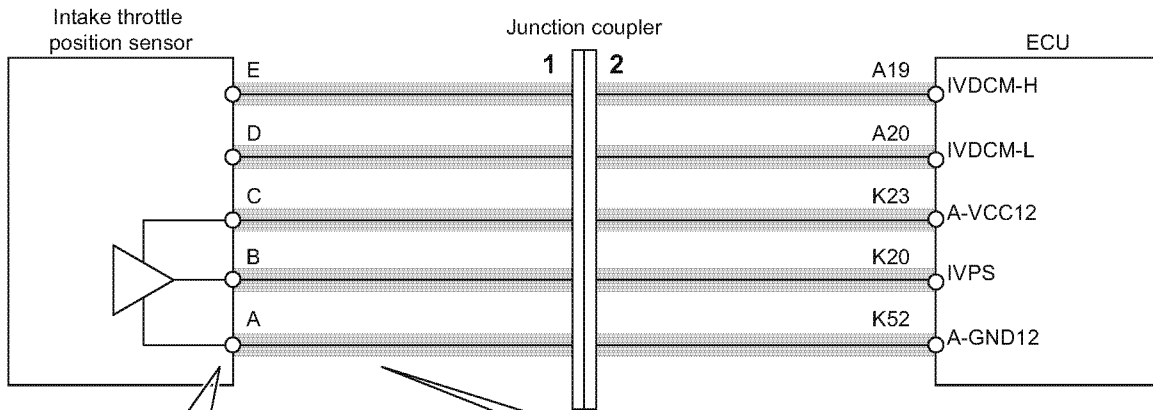

 : Check points

050240-00EN01

Note: See P325 for the ECU pin layout.

● **Work description**

1. Checking the ECU output voltage

- 1- Connect the checker harness between the ECU and engine wire-harness. Also, connect all connectors (sensor, wire-harness, ECU).
- 2- Using a circuit tester, measure the voltage between the intake throttle position sensors 5 V K23 and K52.

Voltage	State	Corrective action
$K23 < 4.375 \text{ V}$	NG	<ul style="list-style-type: none"> • Replace the wire-harness. • Replace the ECU.
$4.375 \text{ V} \leq K23 \leq 5.625 \text{ V}$	OK (Normal range)	Check the intake throttle position sensor output voltage.
$5.625 \text{ V} < K23$	NG	<ul style="list-style-type: none"> • Replace the wire-harness. • Replace the ECU.

NG	Replace the wire-harness or ECU, and turn off and on the key switch and perform the diagnosis using the SMARTASSIST-DIRECT (SA-D).
OK	Go to "Checking the intake throttle position sensor output voltage".

2. Checking the intake throttle position sensor output voltage

- 1- Connect the checker harness between the ECU and engine wire-harness. Also, connect all connectors (sensor, wire-harness, ECU).
- 2- Using a circuit tester, measure the voltage between the sensor signals K20 and K52.

Voltage	State	Corrective action
$K20 < 0.6 \text{ V}$	NG	<ul style="list-style-type: none"> • Replace the wire-harness. • Replace the ECU.
$0.65 \text{ V} \leq K20 \leq 4.4 \text{ V}$	OK (Normal range)	Replace the ECU.
$4.4 \text{ V} < K20$	NG	<ul style="list-style-type: none"> • Replace the wire-harness. • Replace the ECU.

NG	Replace the wire-harness or ECU, and turn off and on the key switch and perform the diagnosis using the SMARTASSIST-DIRECT (SA-D).
OK	Replace the ECU.

3. Operation using SA-D

- 1- Turn off the key switch, turn on the key switch again, and start the engine.
- 2- Connect the SA-D and check the current fault indication to see whether an error is detected.

No	Normal
Applied	Replace the intake throttle.

■ EGR low pressure side pressure sensor

● Related DTC

P code	SPN/FMI	Name
P0238	102/3	EGR low pressure side pressure sensor error (voltage high)
P0237	102/4	EGR low pressure side pressure sensor error (voltage low)
P0236	102/13	EGR low pressure side pressure sensor error (abnormal learning value)

● Workflow

Note: See "Work description" for work details. Go to "SA-D Operation Manual" for the SA-D operation.

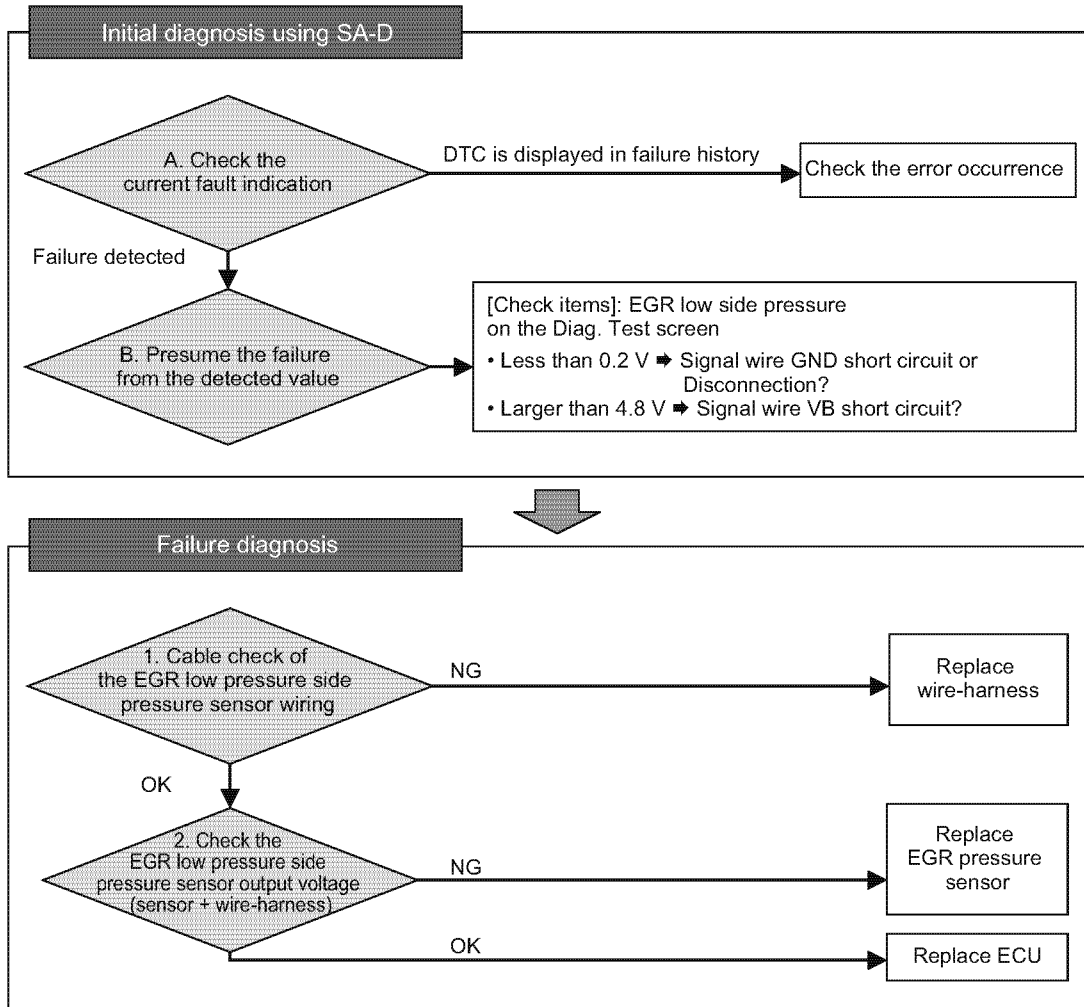

050736-00EN01

● Wire diagram

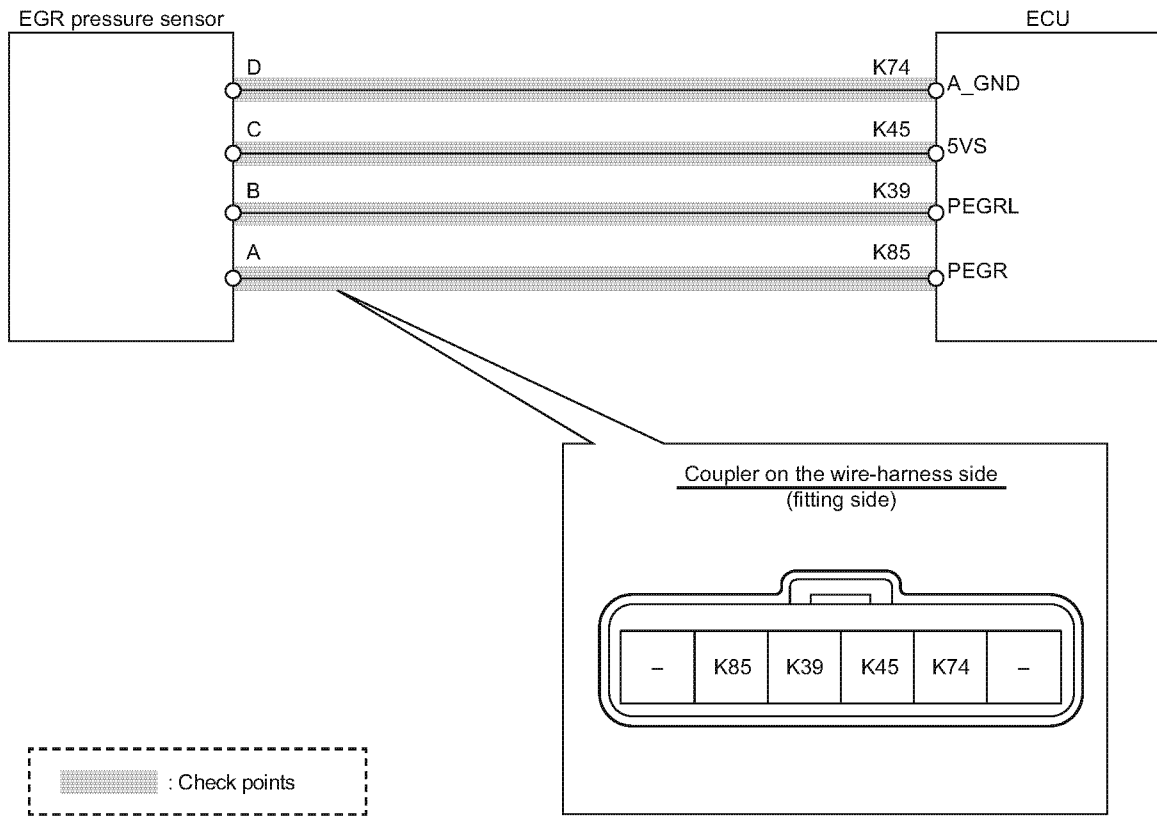

Note: See P325 for the ECU pin layout.

● **Work description**

1. Cable check of the EGR low pressure side pressure sensor wiring

- 1- Remove the wire-harness from the EGR pressure sensor and the ECU.
- 2- Using a circuit tester, check the cable of the wire-harness.

Terminal	Cable check	State
Between B and K39	OK	Normal
	NG	Wire-harness failure
Between C and K45	OK	Normal
	NG	Wire-harness failure
Between D and K74	OK	Normal
	NG	Wire-harness failure

NG	<ul style="list-style-type: none"> • Check if the wire-harness is damaged or there is mis-wiring. • Replace the wire-harness.
OK	Go to "Check the EGR low pressure side pressure sensor output voltage (sensor + wire-harness)".

2. Checking the EGR low pressure side pressure sensor output voltage (sensor + wire-harness)

- 1- Connect the checker harness between the ECU and engine wire-harness. Also, connect all connectors (sensor, ECU).
- 2- Using a circuit tester, measure the voltage value between the EGR low pressure side pressure sensor signals K39 and K74.

Voltage	State	Corrective action
$K39 < 0.2 \text{ V}$	NG	<ul style="list-style-type: none"> • Replace the wire-harness. • Replace the ECU.
$0.2 \text{ V} \leq K39 \leq 4.8 \text{ V}$	OK (normal range)	Replace the ECU.
$4.8 \text{ V} < K39$	NG	<ul style="list-style-type: none"> • Replace the wire-harness. • Replace the ECU.

NG	Replace the EGR pressure sensor. Then, check the output voltage again.
OK	Replace the ECU.

● Related DTC

P code	SPN/FMI	Name
P1673	102/10	EGR low pressure side pressure sensor error (detected value error)

● Workflow

Note: See "Work description" for work details. Go to "SA-D Operation Manual" for the SA-D operation.

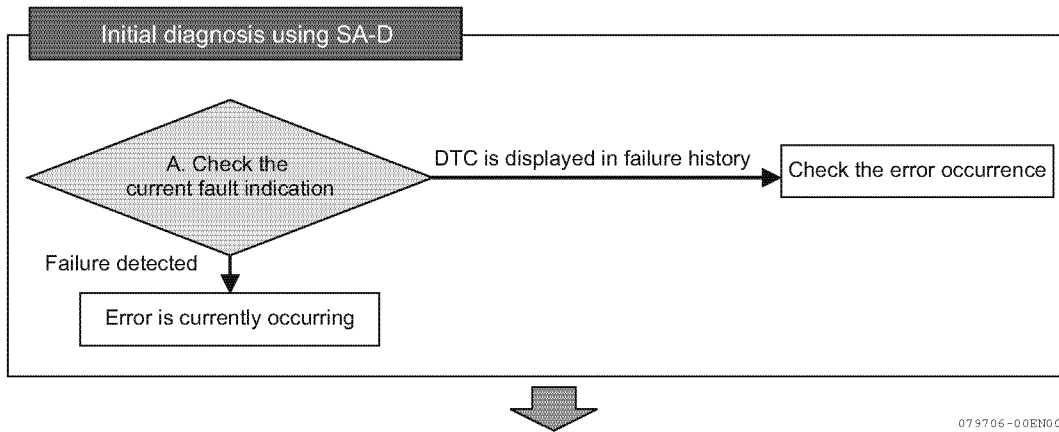

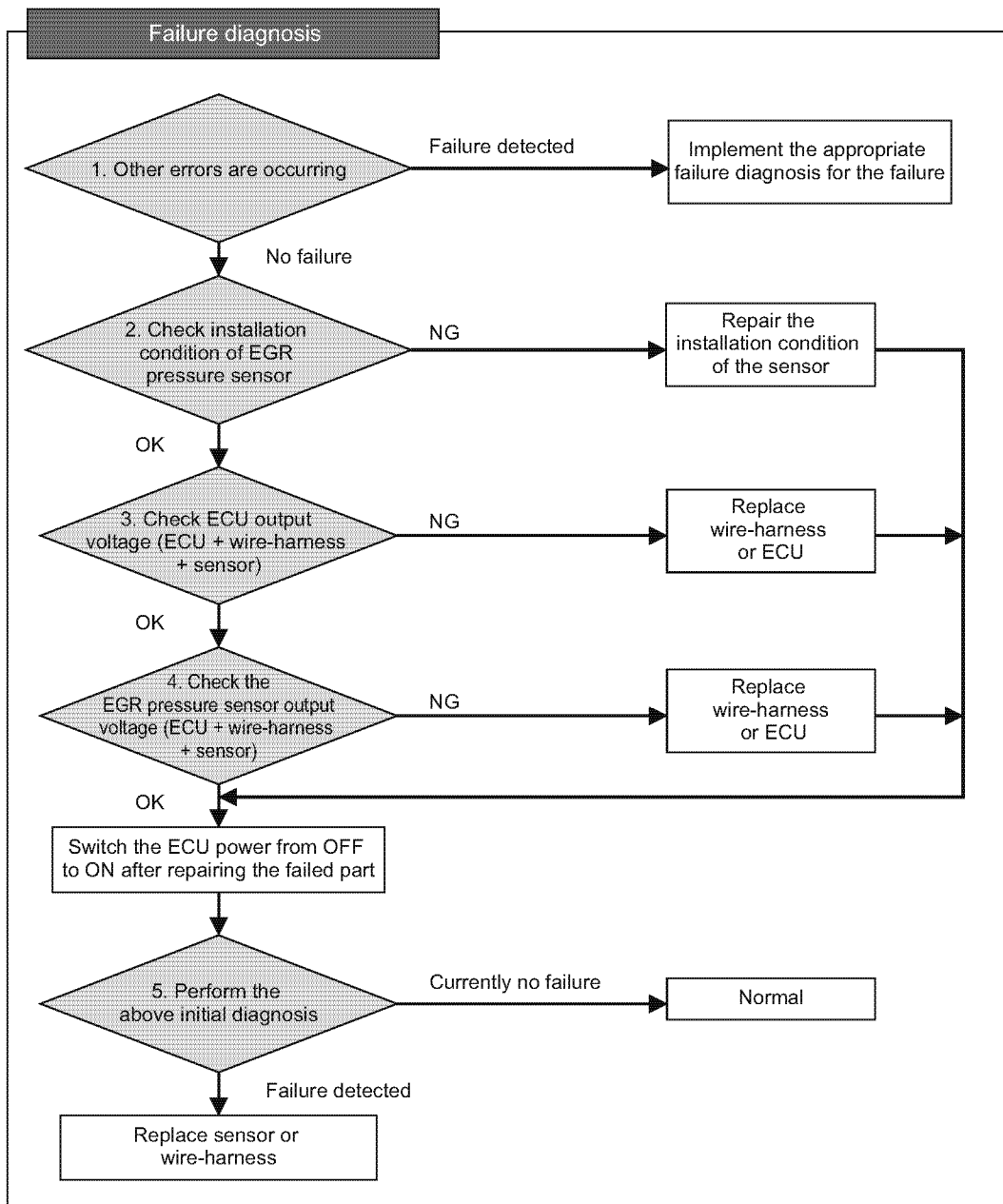

079739-00EN00

● Wire diagram

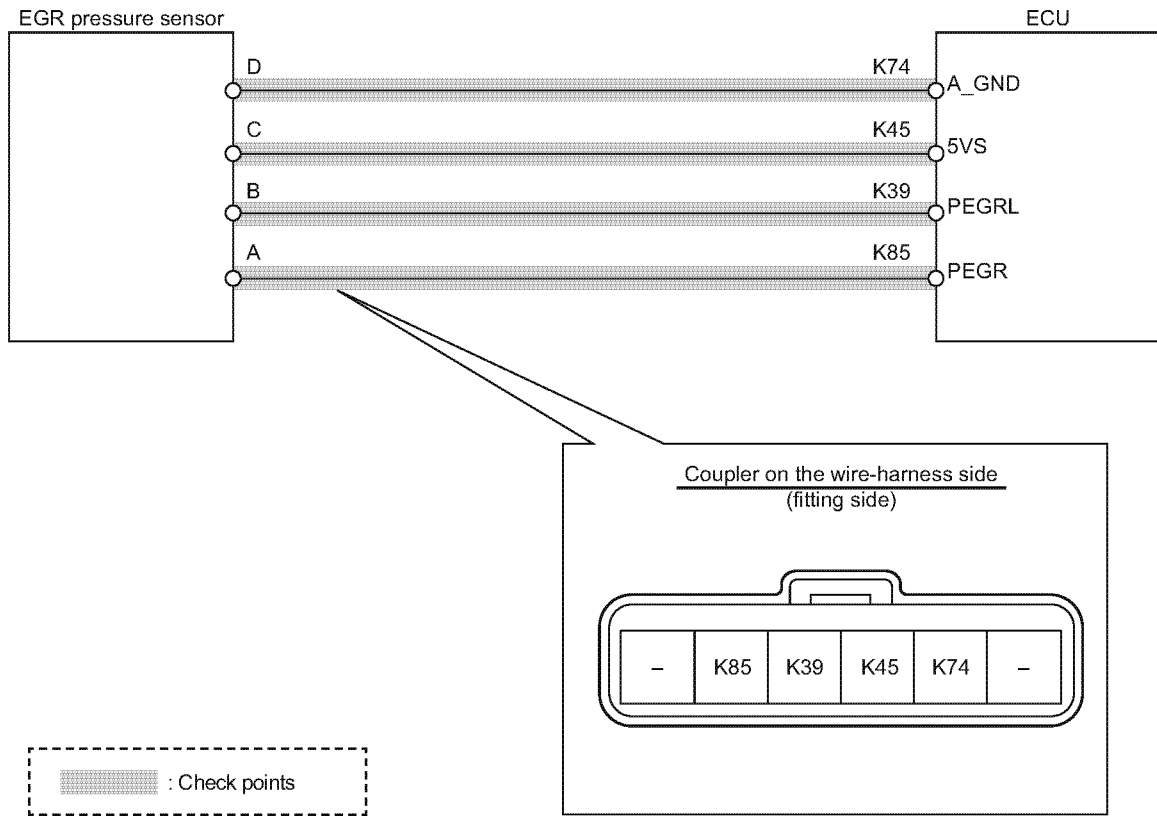

050737-00E2100

Note: See P325 for the ECU pin layout.

● **Work description**

1. Checking for other errors

- 1-Turn off the key switch and turn on the key switch again.
- 2-Connect the SA-D and check the current fault indication to see whether any other errors are detected. Particularly, check to see whether any errors are detected for EGR pressure sensor, atmospheric pressure sensor, engine coolant temperature sensor, ambient air temperature sensor, sensor 5 V circuit 2, or inside the ECU.

Error detected	Implement the appropriate failure diagnosis for the failure.
No error detected	Go to "Checking the installation condition of EGR pressure sensor".

2. Checking the installation condition of EGR pressure sensor

- 1-Turn off the key switch.
- 2-Check the installation condition of EGR pressure sensor.
- 3-Make sure that there is nothing wrong (disconnections and damages) with the exhaust piping, pressure hose, or pressure pipe.

NG	Reinstall the sensor, and turn off/on the ECU power for failure diagnosis using SA-D.
OK	Go to "Checking the ECU output voltage".

3. Checking the ECU output voltage

- 1-Connect the checker harness between the ECU and engine wire-harness. Also, connect all connectors (sensor, wire-harness, ECU).
- 2-Using a circuit tester, measure the voltage between EGR pressure sensors 5 V K45 and K74.

Voltage	State	Corrective action
$K45 < 4.375 \text{ V}$	NG	<ul style="list-style-type: none"> • Replace the wire-harness. • Replace the ECU.
$4.375 \text{ V} \leq K45 \leq 5.625 \text{ V}$	OK (normal range)	Check the EGR pressure sensor output voltage.
$5.625 \text{ V} < K45$	NG	<ul style="list-style-type: none"> • Replace the wire-harness. • Replace the ECU.

NG	Replace the wire-harness or ECU, and turn off and on the ECU power for failure diagnosis using SA-D.
OK	Go to "Checking the EGR pressure sensor output voltage".

4. Checking the EGR pressure sensor output voltage

- 1-Connect the checker harness between the ECU and engine wire-harness. Also, connect all connectors (sensor, wire-harness, ECU).
- 2-Using a circuit tester, measure the voltage of the sensor signal between K45 (K85) and K74.

Voltage	State	Corrective action
$K45 (K85) < 0.5 \text{ V}$	NG	<ul style="list-style-type: none"> • Replace the wire-harness. • Replace the ECU.
$0.5 \text{ V} \leq K45 (K85) \leq 4.5 \text{ V}$	OK (normal range)	Perform failure diagnosis using SA-D.
$4.5 \text{ V} < K45 (K85)$	NG	<ul style="list-style-type: none"> • Replace the wire-harness. • Replace the ECU.

NG	Replace the wire-harness or ECU, and turn off and on the ECU power for failure diagnosis using SA-D.
OK	Switch the ECU power from OFF to ON for failure diagnosis using SA-D.

5. Operation using SA-D

- 1-Turn off the key switch and turn on the key switch again to start the engine. Operate the engine that satisfies the reset criteria for P1673: EGR low pressure side pressure sensor error (detected value error) (P50).
- 2-Connect the SA-D and check the current fault indication to see whether an error is detected.

No	Normal
Yes	Replace the EGR pressure sensor or ECU.

■ EGR high pressure side pressure sensor

● Related DTC

P code	SPN/FMI	Name
P0473	1209/3	EGR high pressure side pressure sensor error (voltage high)
P0472	1209/4	EGR high pressure side pressure sensor error (voltage low)
P0471	1209/13	EGR high pressure side pressure sensor error (abnormal learning value)
P1679	1209/10	EGR high pressure side pressure sensor error (detected value error)

● Workflow

Note: See "Work description" for work details. Go to "SA-D Operation Manual" for the SA-D operation.

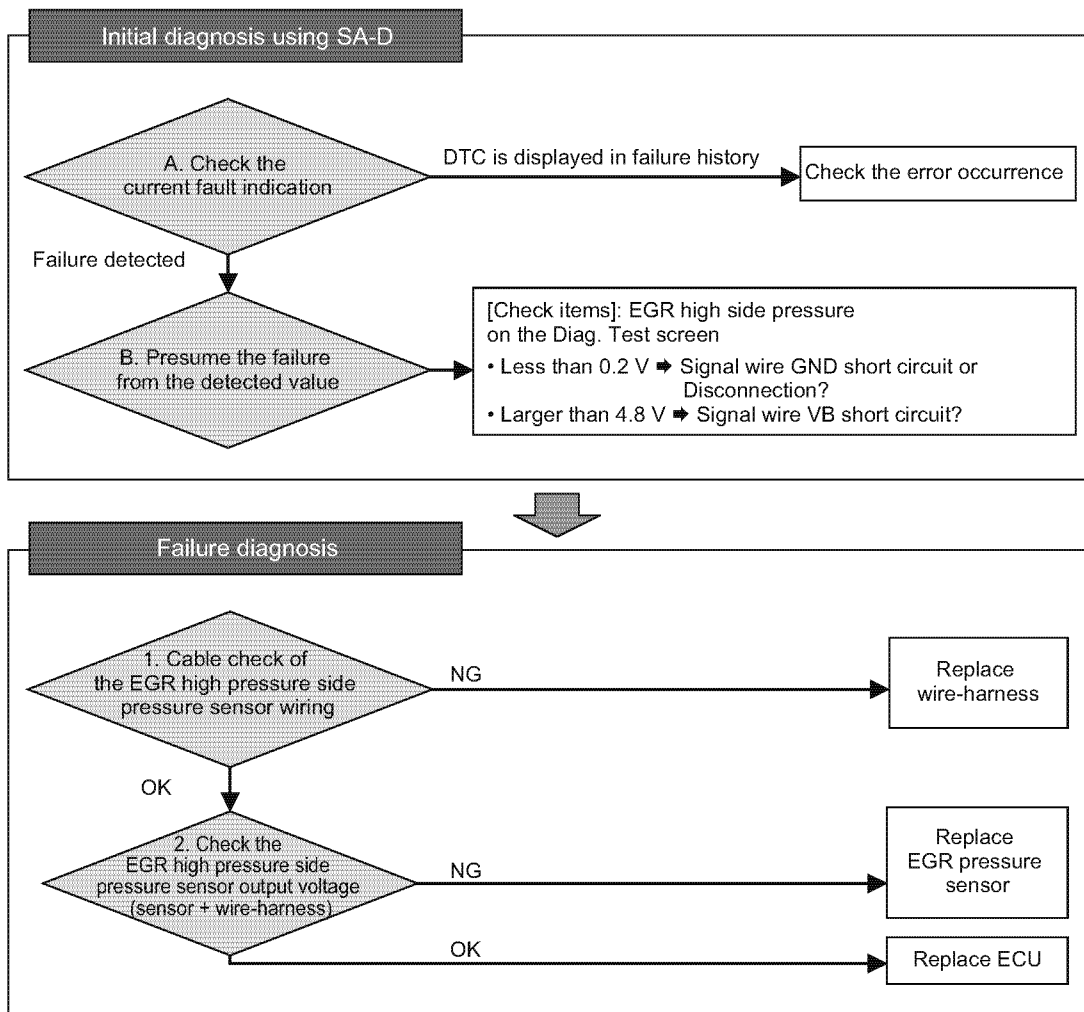

050738-00EN01

● Wire diagram

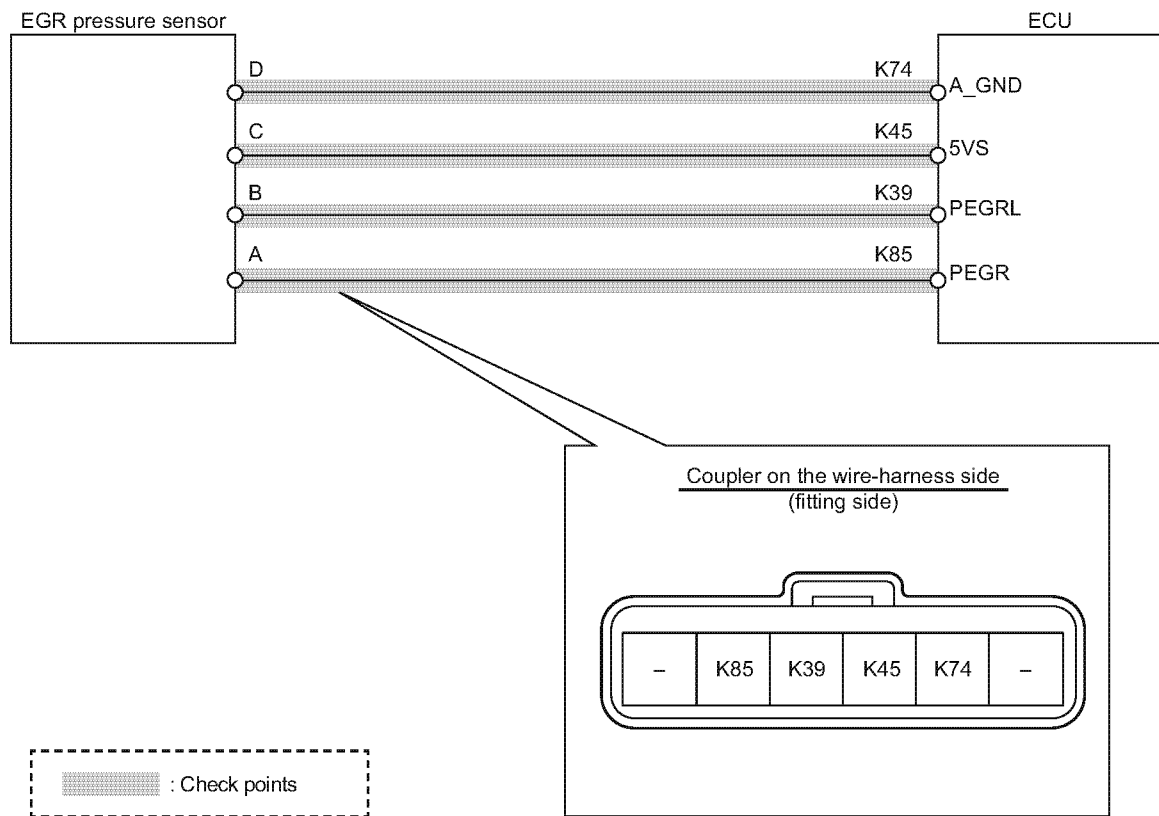

Note: See P325 for the ECU pin layout.

● **Work description**

1. Cable check of the EGR high pressure side pressure sensor wiring

- 1- Remove the wire-harness from the EGR pressure sensor and the ECU.
- 2- Using a circuit tester, check the cable of the wire-harness.

Terminal	Cable check	State
Between A and K85	OK	Normal
	NG	Wire-harness failure
Between C and K45	OK	Normal
	NG	Wire-harness failure
Between D and K74	OK	Normal
	NG	Wire-harness failure

NG	<ul style="list-style-type: none"> • Check if the wire-harness is damaged or there is mis-wiring. • Replace the wire-harness.
OK	Go to "Check the EGR high pressure side pressure sensor output voltage (sensor + wire-harness)".

2. Checking the EGR high pressure side pressure sensor output voltage (sensor + wire-harness)

- 1- Connect the checker harness between the ECU and engine wire-harness. Also, connect all connectors (sensor, ECU).
- 2- Using a circuit tester, measure the voltage value between the EGR high pressure side pressure sensor signals K85 and K74.

Voltage	State	Corrective action
$K85 < 0.2 \text{ V}$	NG	<ul style="list-style-type: none"> • Replace the wire-harness. • Replace the ECU.
$0.2 \text{ V} \leq K85 \leq 4.8 \text{ V}$	OK (normal range)	Replace the ECU.
$4.8 \text{ V} < K85$	NG	<ul style="list-style-type: none"> • Replace the wire-harness. • Replace the ECU.

NG	Replace the EGR pressure sensor. Then, check the output voltage again.
OK	Replace the ECU.

■ Engine coolant temperature sensor

● Related DTC

P code	SPN/FMI	Name
P0118	110/3	Engine coolant temperature sensor error (voltage high)
P0117	110/4	Engine coolant temperature sensor error (voltage low)
P0217	110/0	Engine coolant temperature high (overheat)

● Workflow

Note: See "Work description" for work details. Go to "SA-D Operation Manual" for the SA-D operation.

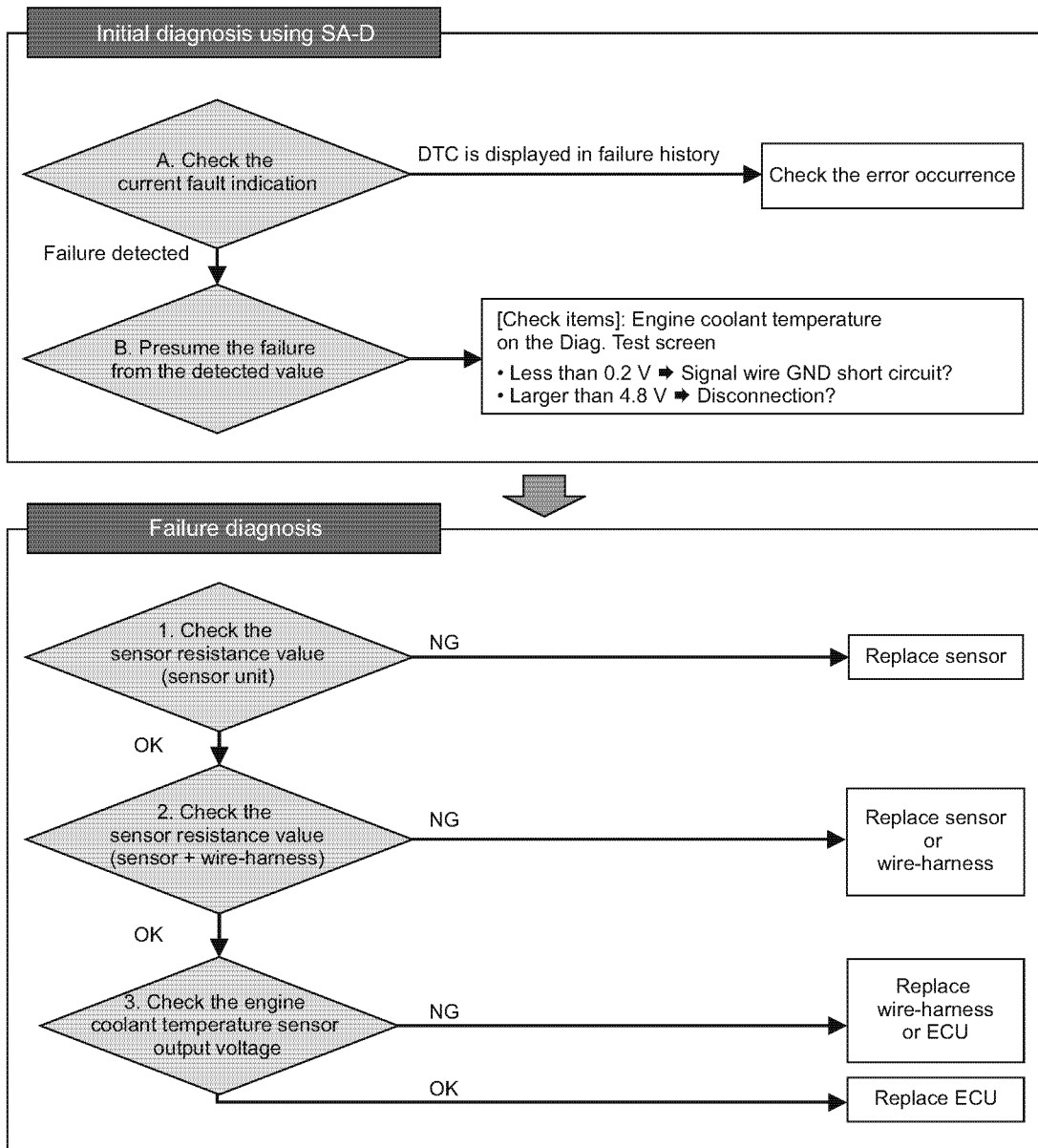

044383-01EN01

● Sensor diagram

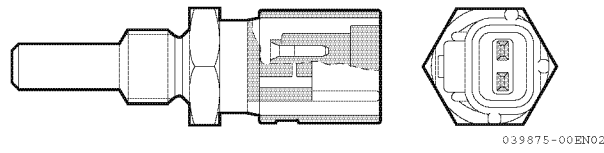

● Wire diagram

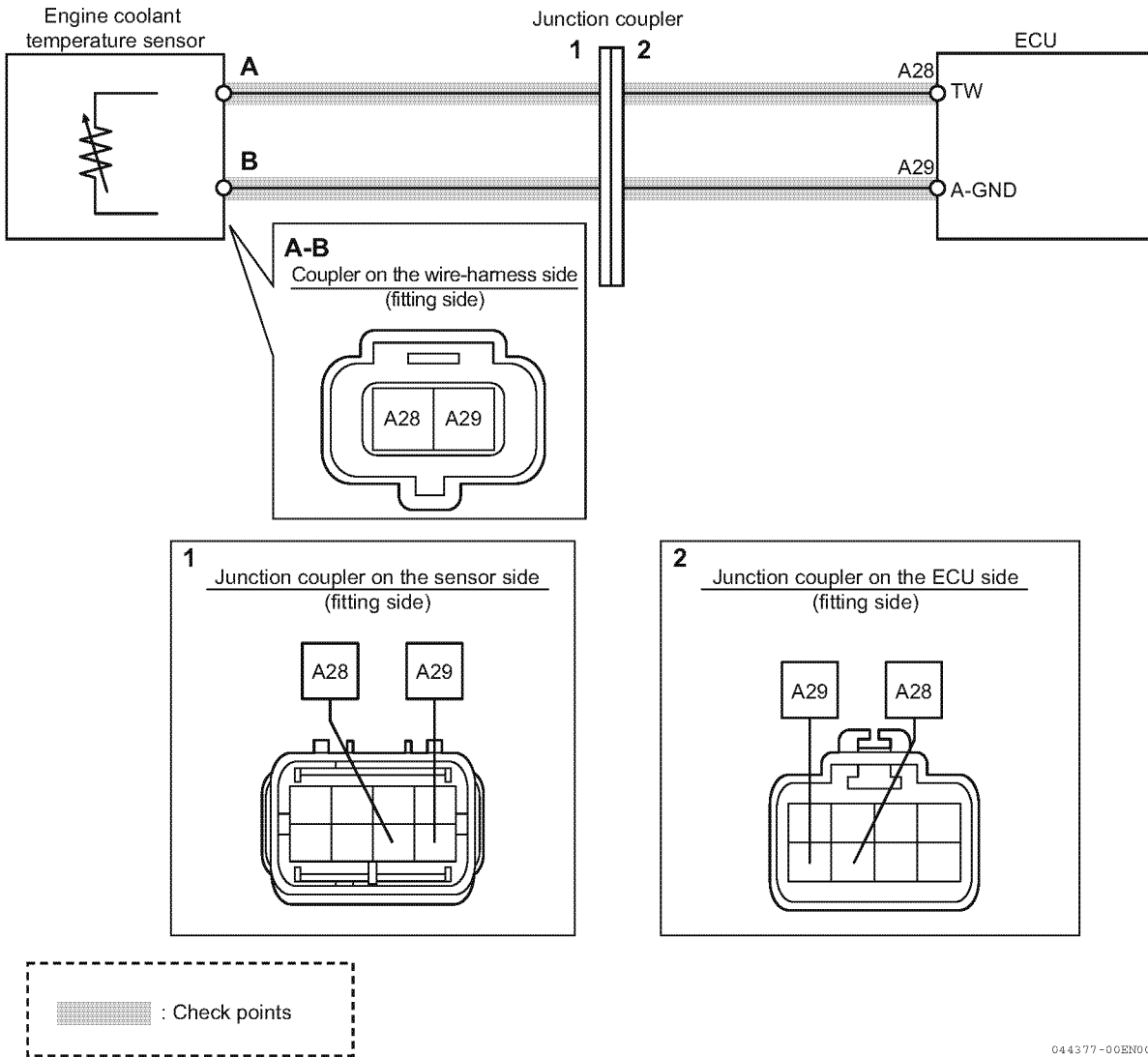

Note: See P325 for the ECU pin layout.

● Work description

1. Checking the sensor resistance value (sensor unit)

- 1- Remove the wire-harness from the engine coolant temperature sensor.
- 2- Using a circuit tester, measure the resistance value between engine coolant temperature sensor terminals A and B.
- 3- Using “Engine coolant temperature sensor characteristics”, make sure that the measured resistance value is within the normal range.

Engine coolant temperature sensor characteristics

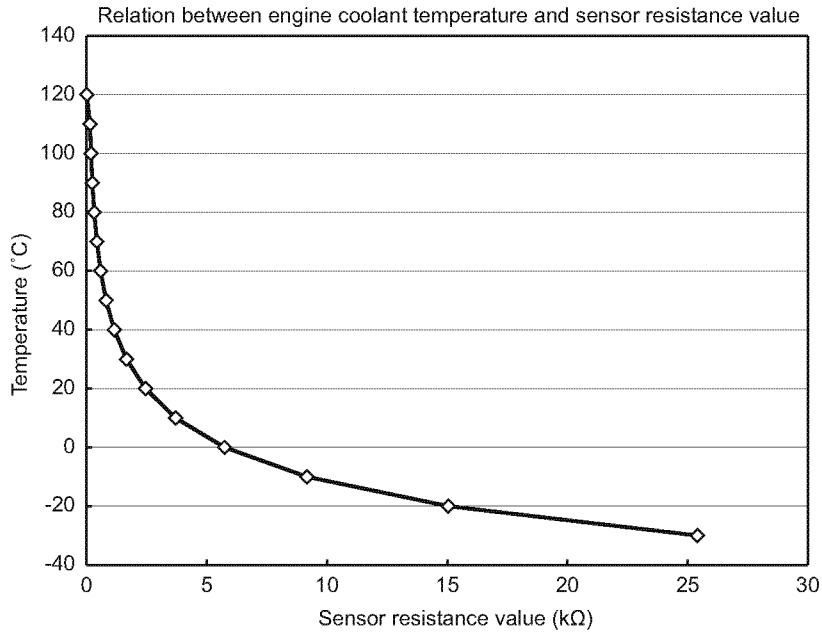

Temperature (°C)	Sensor resistance value (kΩ)
-30	25.40
-20	15.04
-10	9.16
0	5.74
10	3.70
20	2.45
30	1.66
40	1.15
50	0.811
60	0.584
70	0.428
80	0.318
90	0.240
100	0.184
110	0.142
120	0.111

043366-01EN00

NG	Replace the engine coolant temperature sensor.
OK	Go to “Checking the sensor resistance value (sensor and wire-harness)”.

2. Checking the sensor resistance value (sensor and wire-harness)

- 1-Connect the engine coolant temperature sensor and wire-harness, then remove the ECU from the wire-harness.
- 2-Using a circuit tester, measure the resistance value between ECU connector terminals A28 and A29 on the wire-harness side.
- 3-Using "Engine coolant temperature sensor characteristics", make sure that the measured resistance value is within the normal range.

NG	<ul style="list-style-type: none"> • The coupler between the sensor and the wire-harness may be defective. Replace the sensor. • Replace the wire-harness.
OK	Go to "Checking the engine coolant temperature sensor output voltage".

3. Checking the engine coolant temperature sensor output voltage

- 1-Connect the checker harness between the ECU and engine wire-harness. Also connect all connectors (sensor, ECU).
- 2-Using a circuit tester, measure the voltage of the engine coolant temperature sensor signals between A28 and A29.

Voltage	State	Corrective action
$A28 < 0.2 \text{ V}$	NG	<ul style="list-style-type: none"> • Replace the wire-harness. • Replace the ECU.
$0.2 \text{ V} \leq A28 \leq 4.8 \text{ V}$	OK (normal range)	Replace the ECU.
$4.8 \text{ V} < A28$	NG	<ul style="list-style-type: none"> • Replace the wire-harness. • Replace the ECU.

NG	<ul style="list-style-type: none"> • The coupler between the wire-harness and the ECU may be defective. Replace the wire-harness. • Replace the ECU.
OK	Replace the ECU.

● Related DTC

P code	SPN/FMI	Name
P1674	110/10	Engine coolant temperature sensor error (detected value error)

● Workflow

Note: See "Work description" for work details. Go to "SA-D Operation Manual" for the SA-D operation.

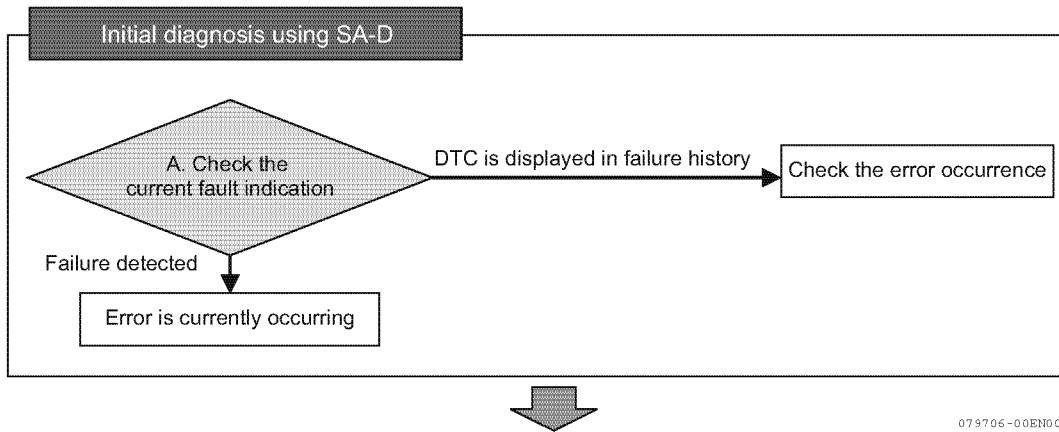

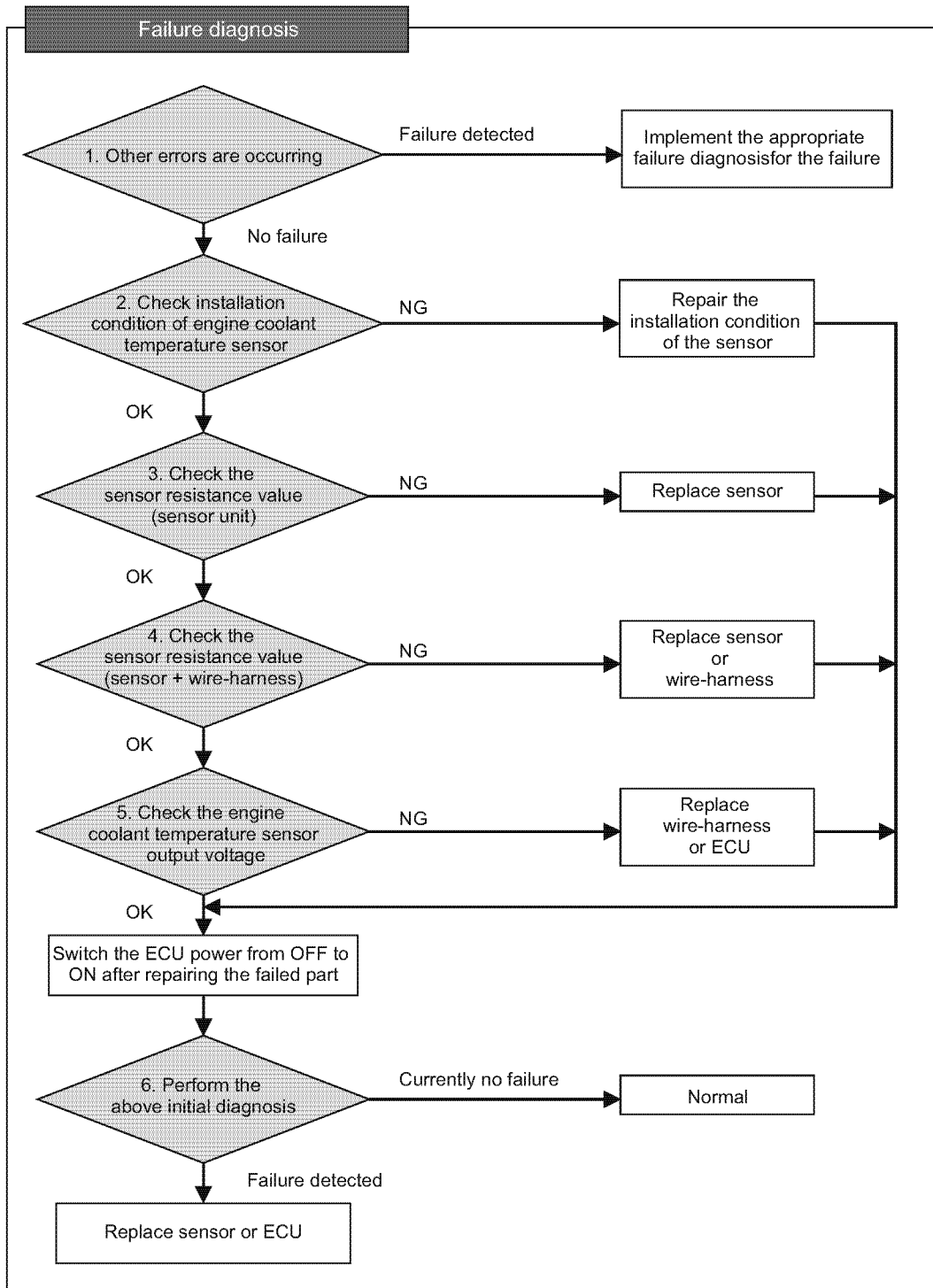

079723-00 EN00

● Wire diagram

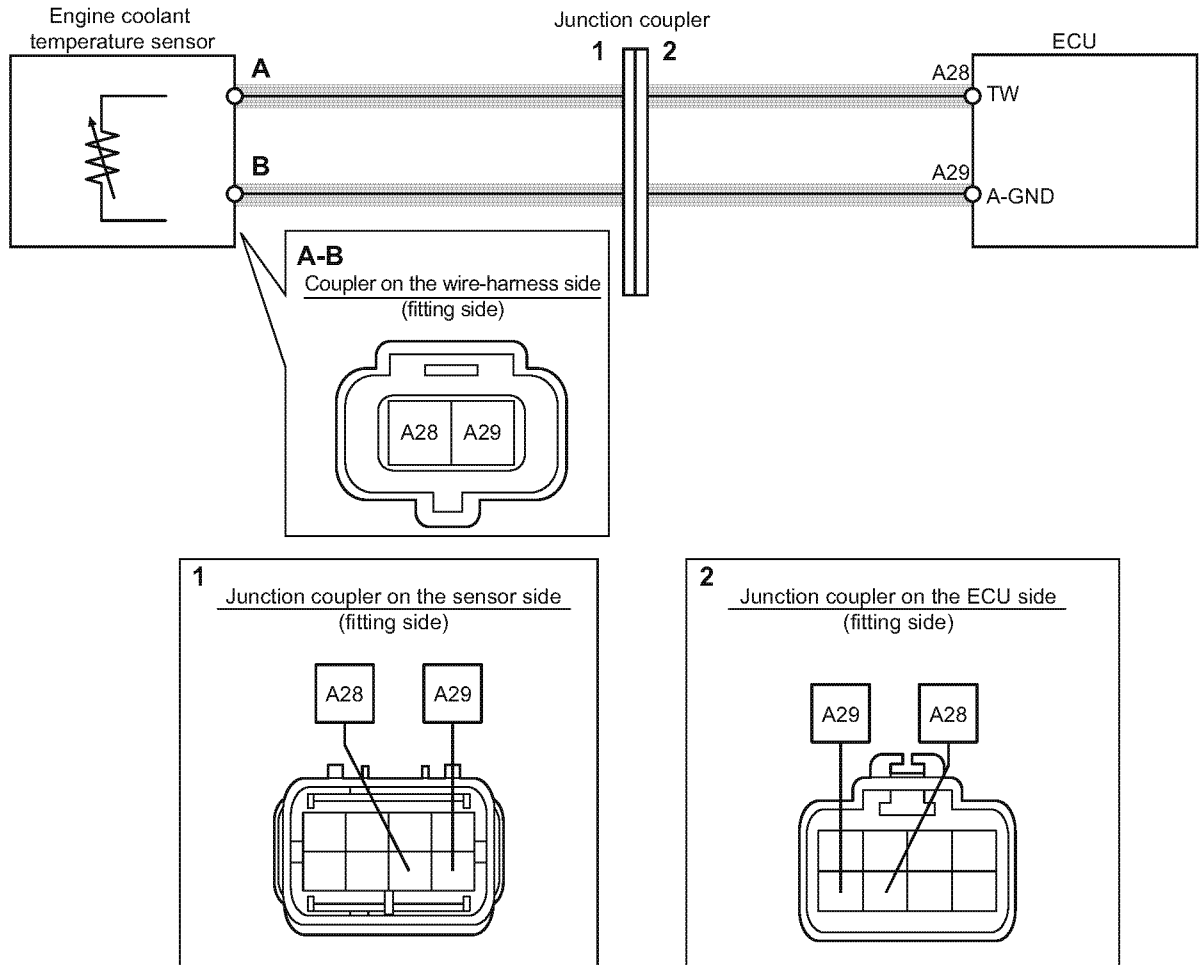

 : Check points

Note: See P325 for the ECU pin layout.

044377-00EN00

● **Work description**

1. Checking for other errors

1-Turn off the key switch and turn on the key switch again.

2-Connect the SA-D and check the current fault indication to see whether any other errors are detected.

Particularly, check to see whether any errors are detected for engine coolant temperature sensor or inside the ECU.

Error detected	Implement the appropriate failure diagnosis for the failure.
No error detected	Go to "Checking installation condition of engine coolant temperature sensor".

2. Checking installation condition of engine coolant temperature sensor

1-Turn off the key switch.

2-Check the installation condition of engine coolant temperature sensor.

3-Make sure that there is nothing wrong (disconnections and damages) with the engine coolant piping or cooling system.

NG	Reinstall the sensor, and turn off/on the ECU power for failure diagnosis using SA-D.
OK	Go to "Checking the sensor resistance value (sensor unit)".

3. Checking the sensor resistance value (sensor unit)

1-Remove the wire-harness from the engine coolant temperature sensor.

2-Using a circuit tester, measure the resistance value between engine coolant temperature sensor terminals A and B.

3-Using "Engine coolant temperature sensor characteristics", make sure that the measured resistance value is within the normal range.

Engine coolant temperature sensor characteristics

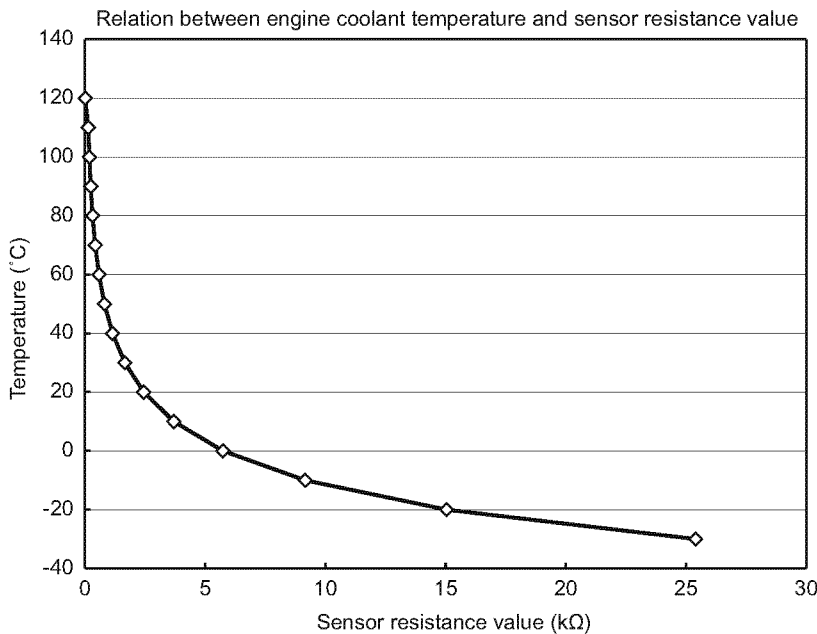

Temperature (°C)	Sensor resistance value (kΩ)
-30	25.40
-20	15.04
-10	9.16
0	5.74
10	3.70
20	2.45
30	1.66
40	1.15
50	0.811
60	0.584
70	0.428
80	0.318
90	0.240
100	0.184
110	0.142
120	0.111

043366-01EN00

NG	Replace the engine coolant temperature sensor, and switch the ECU power from OFF to ON for failure diagnosis using SA-D.
OK	Go to "Checking the sensor resistance value (sensor and wire-harness)".

4. Checking the sensor resistance value (sensor and wire-harness)

- 1-Connect the engine coolant temperature sensor and wire-harness, then remove the ECU from the wire-harness.
- 2-Using a circuit tester, measure the resistance value between ECU connector terminals A28 and A29 on the wire-harness side.
- 3-Using "Engine coolant temperature sensor characteristics", make sure that the measured resistance value is within the normal range.

NG	<ul style="list-style-type: none"> • The coupler between the sensor and the wire-harness may be defective. Replace the sensor. • Replace the wire-harness. Switch the ECU power from OFF to ON for failure diagnosis using SA-D after replacement.
OK	Go to "Checking the engine coolant temperature sensor output voltage".

5. Checking the engine coolant temperature sensor output voltage

- 1-Connect the checker harness between the ECU and engine wire-harness. Also connect all connectors (sensor, ECU).
- 2-Using a circuit tester, measure the voltage of the engine coolant temperature sensor signals between A28 and A29.

Voltage	State	Corrective action
A28 < 0.1 V	NG	<ul style="list-style-type: none"> • Replace the wire-harness. • Replace the ECU.
0.1 V ≤ A28 ≤ 4.8 V	OK (normal range)	Perform failure diagnosis using SA-D.
4.8 V < A28	NG	<ul style="list-style-type: none"> • Replace the wire-harness. • Replace the ECU.

NG	<ul style="list-style-type: none"> • The coupler between the wire-harness and the ECU may be defective. Replace the wire-harness. • Replace the ECU. Switch the ECU power from OFF to ON for failure diagnosis using SA-D after replacement.
OK	Switch the ECU power from OFF to ON for failure diagnosis using SA-D.

6. Operation using SA-D

- 1-Turn off the key switch and turn on the key switch again to start the engine. Operate the engine that satisfies the reset criteria for P1674: Engine coolant temperature sensor error (detected value error) (P64).
- 2-Connect the SA-D and check the current fault indication to see whether an error is detected.

No	Normal
Yes	Replace the engine coolant temperature sensor or ECU.

■ Ambient air temperature sensor

● Related DTC

P code	SPN/FMI	Name
P0113	172/3	Ambient air temperature sensor error (voltage high)
P0112	172/4	Ambient air temperature sensor error (voltage low)

● Workflow

Note: See "Work description" for work details. Go to "SA-D Operation Manual" for the SA-D operation.

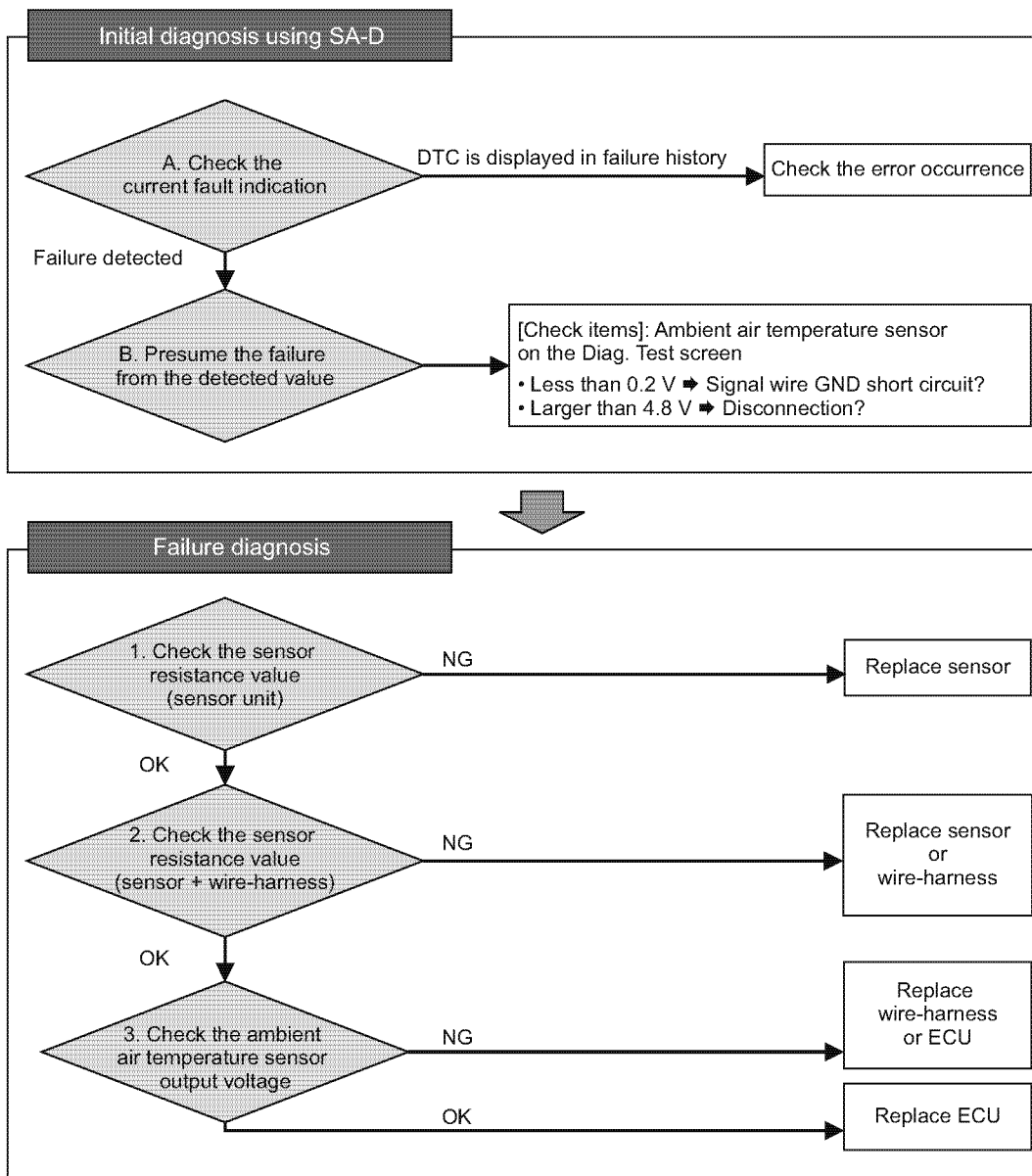

044384-01EN01

● Wire diagram

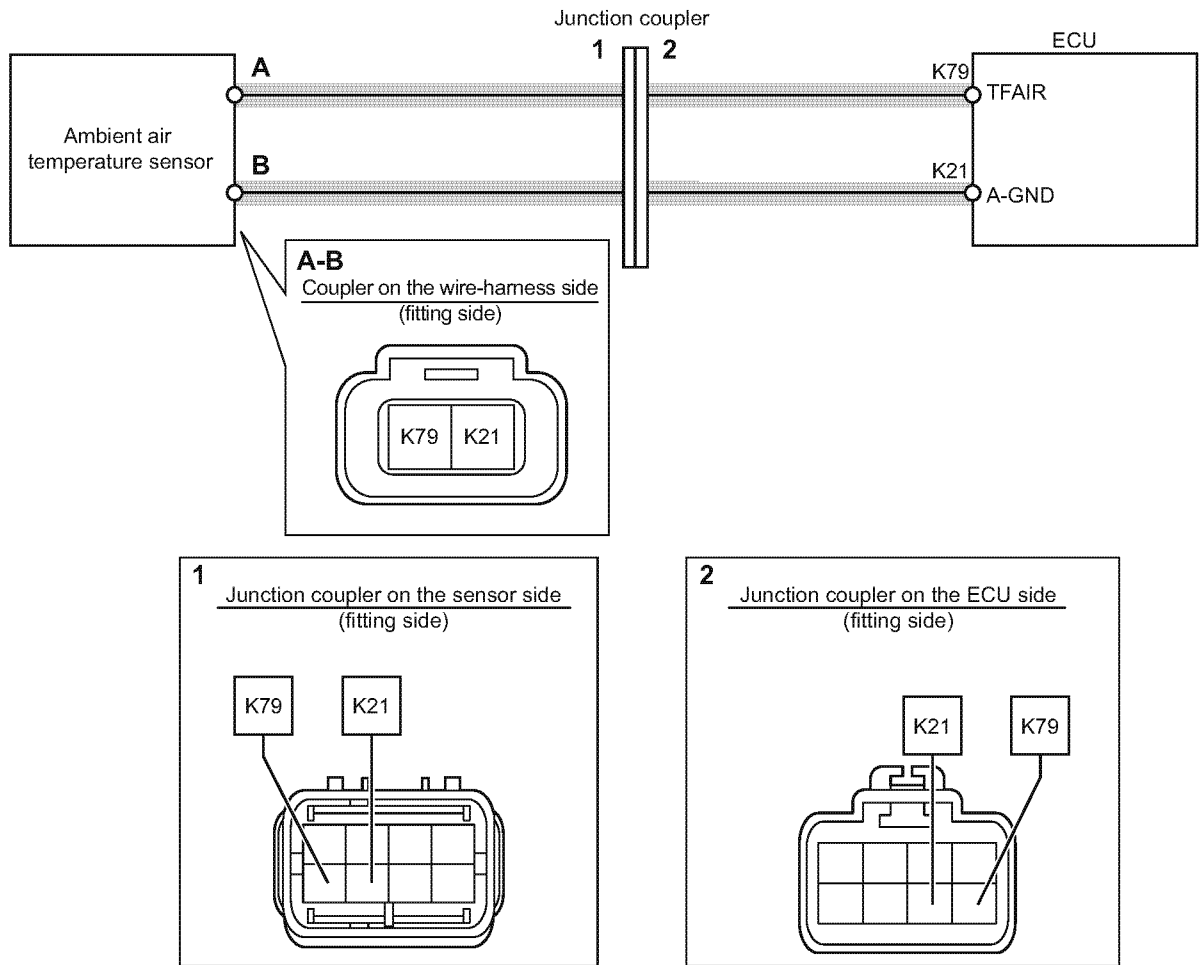

 : Check points

044375-00E100

Note: See P325 for the ECU pin layout.

● Work description

1. Checking the sensor resistance value (sensor unit)

- 1-Remove the wire-harness from the ambient air temperature sensor.
- 2-Using a circuit tester, measure the resistance value between ambient air temperature sensor terminals A and B.
- 3-Using “Ambient air temperature sensor characteristics”, make sure that the measured resistance value is within the normal range.

Ambient air temperature sensor characteristics

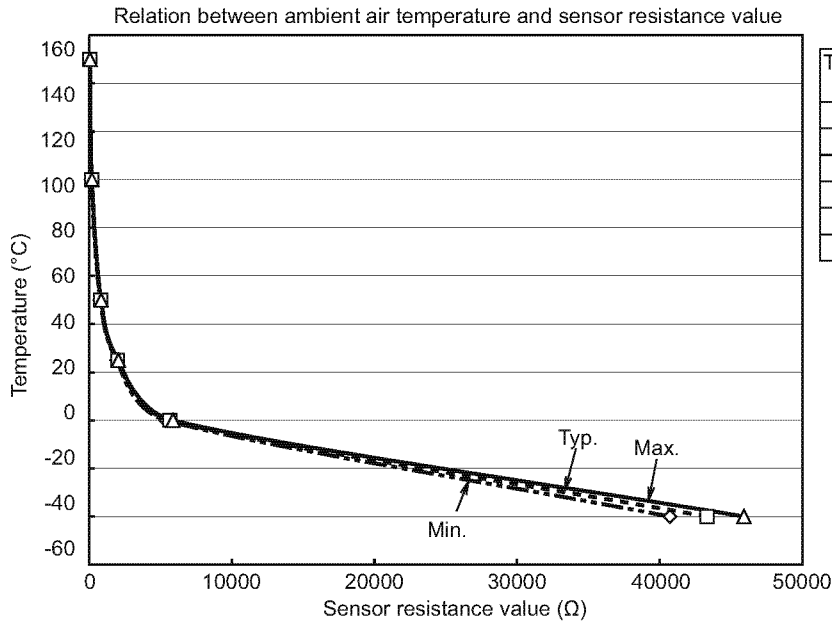

Temperature (°C)	Sensor resistance value (Ω)		
	Min.	Typ.	Max.
-40	40720	43318	45918
0	5417	5652	5886
25	1940	2000	2060
50	783.6	812.8	842.1
100	177.1	186	194.4
150	54.48	57.96	61.44

044298-00EN01

NG	Replace the ambient air temperature sensor.
OK	Go to “Checking the sensor resistance value (sensor and wire-harness)”.

2. Checking the sensor resistance value (sensor and wire-harness)

- 1-Connect the ambient air temperature sensor and wire-harness then remove the ECU from the wire-harness.
- 2-Using a circuit tester, measure the resistance value between ECU connector terminals K79 and K21 on the wire-harness side.
- 3-Using “Ambient air temperature sensor characteristics”, make sure that not the measured resistance value is within the normal range.

NG	<ul style="list-style-type: none"> • The coupler between the sensor and the wire-harness may be defective. Replace the sensor. • Replace the wire-harness.
OK	Go to “Checking the ambient air temperature sensor output voltage”.

3. Checking the ambient air temperature sensor output voltage

1-Connect the checker harness between the ECU and engine wire-harness. Also connect all connectors (sensor, ECU).

2-Using a circuit tester, measure the voltage between ambient air temperature sensor signals K79 and A21.

Voltage	State	Corrective action
$K79 < 0.15 \text{ V}$	NG	<ul style="list-style-type: none"> • Replace the wire-harness. • Replace the ECU.
$0.15 \text{ V} \leq K79 \leq 4.85 \text{ V}$	OK (normal range)	Replace the ECU.
$4.85 \text{ V} < K79$	NG	<ul style="list-style-type: none"> • Replace the wire-harness. • Replace the ECU.

NG	<ul style="list-style-type: none"> • The coupler between the wire-harness and the ECU may be defective. Replace the wire-harness. • Replace the ECU.
OK	Replace the ECU.

■ Fuel temperature sensor

● Related DTC

P code	SPN/FMI	Name
P0182	174/4	Fuel temperature sensor error (voltage low)
P0183	174/3	Fuel temperature sensor error (voltage high)
P0168	174/0	Fuel temperature high

● Workflow

Note: See "Work description" for work details. Go to "SA-D Operation Manual" for the SA-D operation.

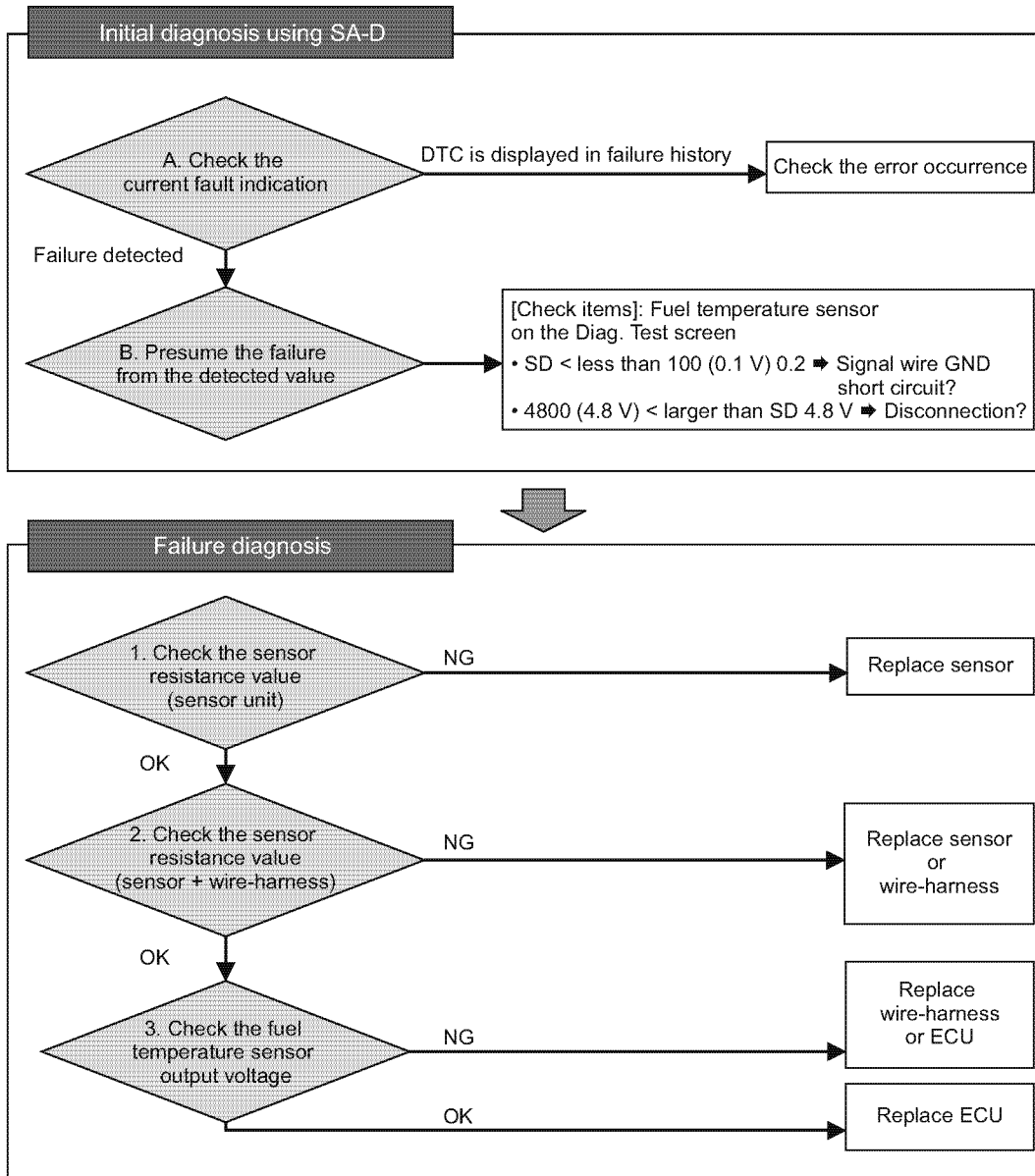

044365-01EN01

● Wire diagram

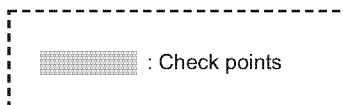
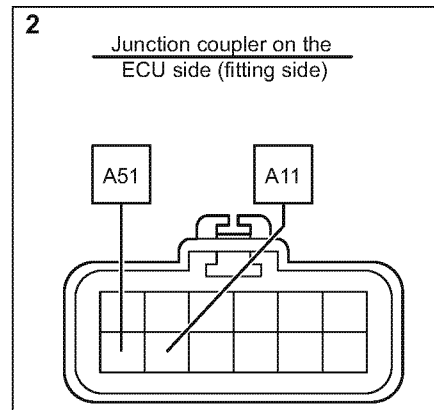
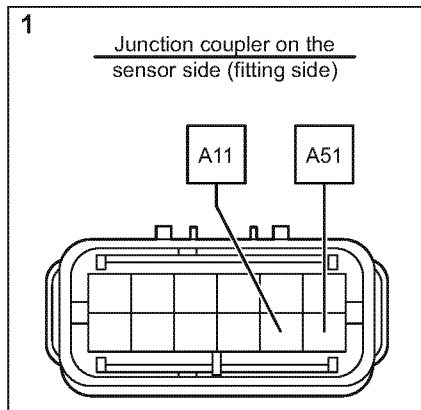
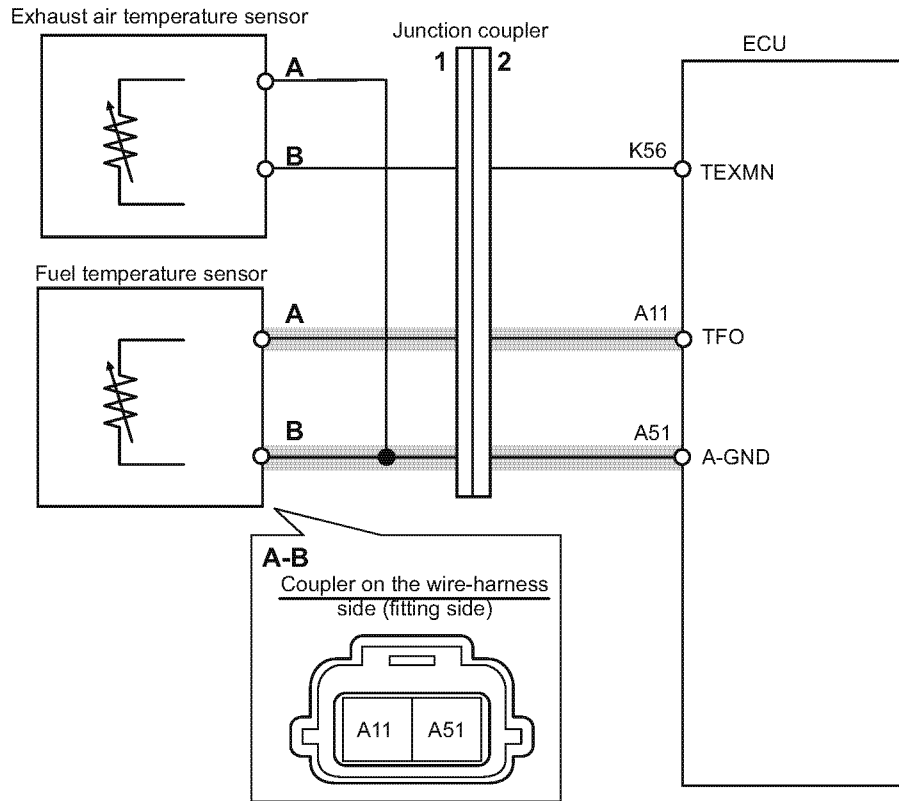

044379-00EN00

Note: See P325 for the ECU pin layout.

● **Work description**

1. Checking the sensor resistance value (sensor unit)

- 1-Remove the wire-harness from the fuel temperature sensor.
- 2-Using a circuit tester, measure the resistance value between fuel temperature sensor terminals A and B.
- 3-Using "Fuel temperature sensor characteristics", make sure that the measured resistance value is within the normal range.

Fuel temperature sensor characteristics

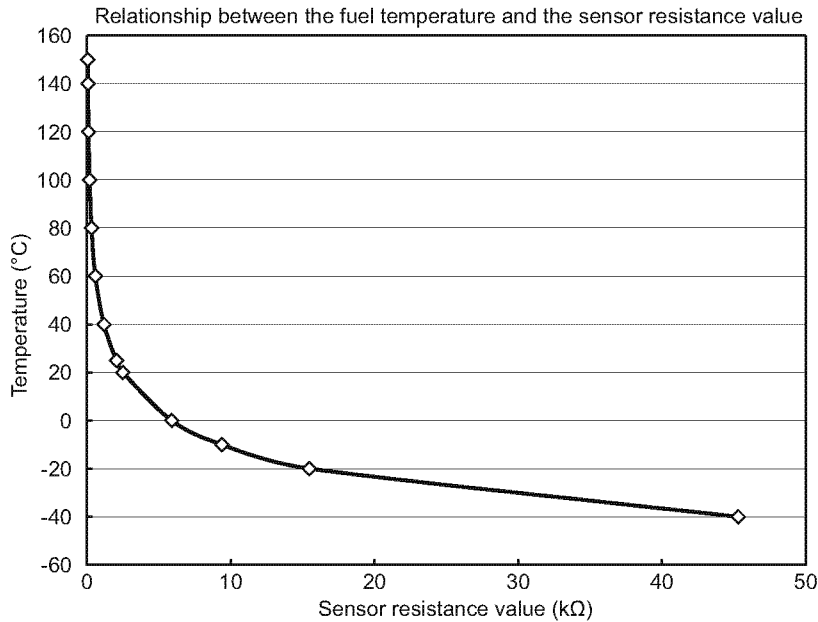

Temp. (°C)	Resistance[kΩ]
-40	45.313
-20	15.462
-10	9.397
0	5.896
20	2.5
25	2.057
40	1.175
60	0.596
80	0.323
100	0.186
120	0.113
140	0.071
150	0.057

044399-00EN00

NG	Replace the fuel temperature sensor.
OK	Go to "Checking the sensor resistance value (sensor and wire-harness)".

2. Checking the sensor resistance value (sensor and wire-harness)

- 1-Connect the fuel temperature sensor and wire-harness, then remove the ECU from the wire-harness.
- 2-Using a circuit tester, measure the resistance value between ECU connector terminals A11 and A51. on the wire-harness side.
- 3-Using "Fuel temperature sensor characteristics", make sure that the measured resistance value is within the normal range.

NG	<ul style="list-style-type: none"> • The coupler between the sensor and the wire-harness may be defective. Replace the sensor. • Replace the wire-harness.
OK	Go to "Checking the fuel temperature sensor output voltage".

3. Checking the fuel temperature sensor output voltage

1-Connect the checker harness between the ECU and engine wire-harness. Also connect all connectors (sensor, ECU).

2-Using a circuit tester, measure the voltage between the sensor signals A11 and A51.

Voltage	State	Corrective action
$A11 < 0.2 \text{ V}$	NG	<ul style="list-style-type: none"> • Replace the wire-harness. • Replace the ECU.
$0.2 \text{ V} \leq A11 \leq 4.8 \text{ V}$	OK (normal range)	Replace the ECU.
$4.8 \text{ V} < A11$	NG	<ul style="list-style-type: none"> • Replace the wire-harness. • Replace the ECU.

NG	<ul style="list-style-type: none"> • The coupler between the fuel temperature sensor and the ECU may be defective. Replace the wire-harness. • Replace the ECU.
OK	Replace the ECU.

■ Rail pressure sensor

● Related DTC

P code	SPN/FMI	Name
P0193	157/3	Rail pressure sensor error (voltage high)
P0192	157/4	Rail pressure sensor error (voltage low)

● Workflow

Note: See "Work description" for work details. Go to "SA-D Operation Manual" for the SA-D operation.

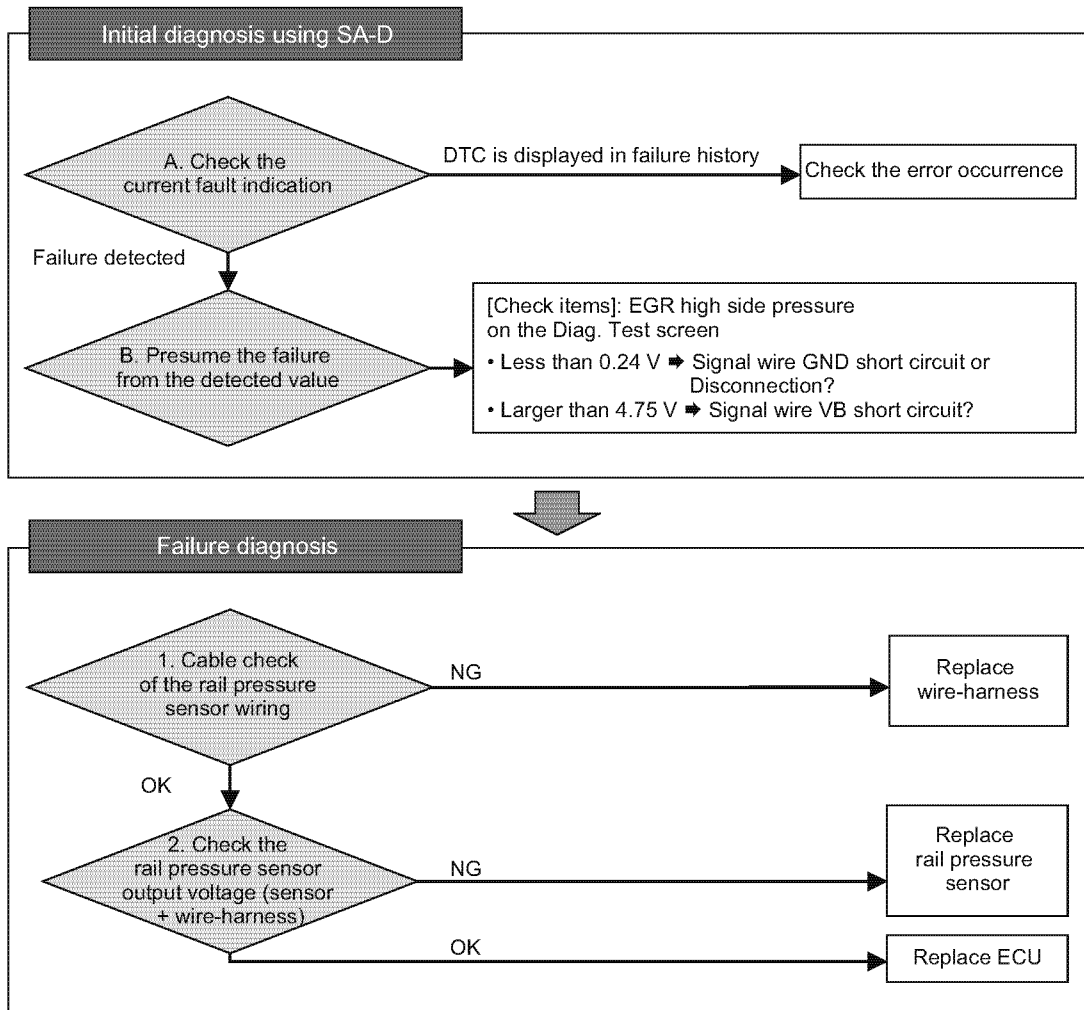

050738-01EN01

● Wire diagram

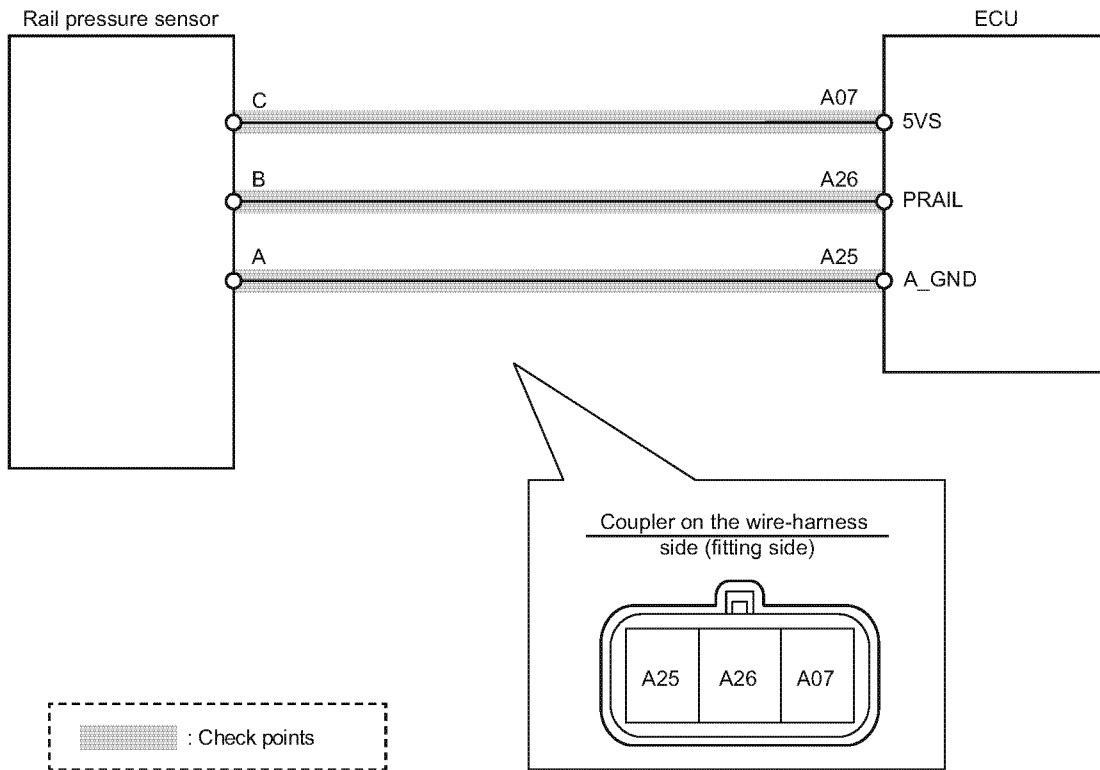

Note: See P325 for the ECU pin layout.

050749-00EN00

● **Work description**

1. Cable check of the rail pressure sensor wiring

- 1-Remove the wire-harness from the rail pressure sensor and the ECU.
- 2-Using a circuit tester, check the cable of the wire-harness.

Terminal	Cable check	State
Between A and A25	OK	Normal
	NG	Wire-harness failure
Between B and A26	OK	Normal
	NG	Wire-harness failure
Between C and A07	OK	Normal
	NG	Wire-harness failure

NG	<ul style="list-style-type: none"> • Check if the wire-harness is damaged or there is mis-wiring. • Replace the wire-harness.
OK	Go to "Check the rail pressure sensor output voltage (sensor + wire-harness)".

2. Checking the rail pressure sensor output voltage (sensor + wire-harness)

- 1-Connect the checker harness between the ECU and engine wire-harness. Also, connect all connectors (sensor, ECU).
- 2-Using a circuit tester, measure the voltage value between the rail pressure sensor signals K26 and K25.

Voltage	State	Corrective action
$A26 < 0.24 \text{ V}$	NG	<ul style="list-style-type: none"> • Replace the wire-harness. • Replace the ECU.
$0.24 \text{ V} \leq A26 \leq 4.75 \text{ V}$	OK (normal range)	Replace the ECU.
$4.75 \text{ V} < A26$	NG	<ul style="list-style-type: none"> • Replace the wire-harness. • Replace the ECU.

NG	Replace the rail pressure sensor. Then, check the output voltage again.
OK	Replace the ECU.

■ DPF differential pressure sensor

● Related DTC

P code	SPN/FMI	Name
P2455	3251/3	DPF differential pressure sensor error (voltage high)
P2454	3251/4	DPF differential pressure sensor error (voltage low)
P1455	3609/3	DPF high pressure side pressure sensor error (voltage high)
P1454	3609/4	DPF high pressure side pressure sensor error (voltage low)
P167C	3609/10	DPF high pressure side pressure sensor error (detected value error)
P2453	3251/13	DPF differential pressure sensor error (abnormal learning value)
P2452	3251/0	DPF differential pressure sensor differential pressure rise error
P226D	4795/31	DPF substrate/DPF differential pressure sensor error (DPF substrate removal/DPF differential pressure sensor detected value error)

● Workflow

Note: See "Work description" for work details. Go to "SA-D Operation Manual" for the SA-D operation.

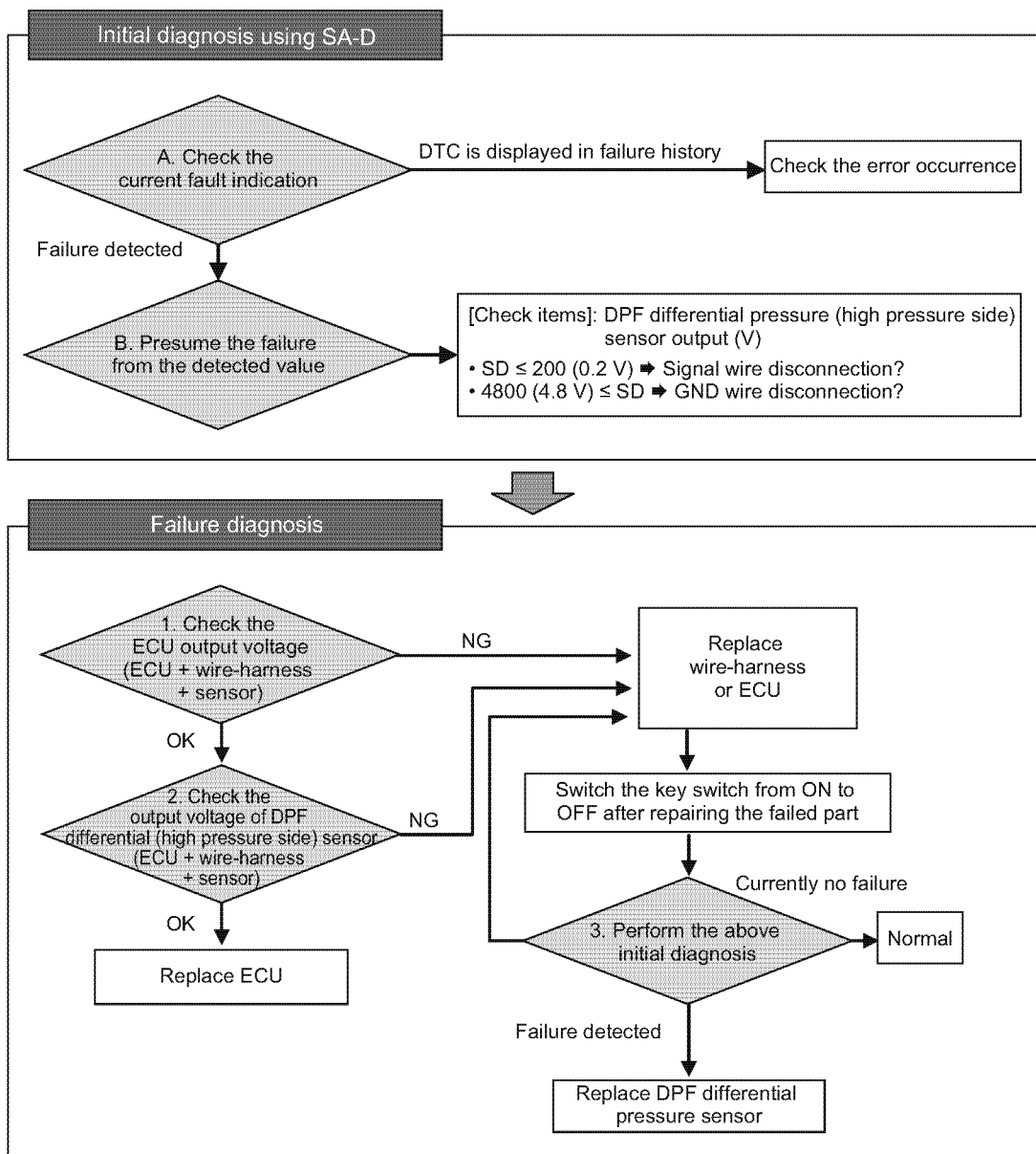

050233-01EN01

● Wiring diagram

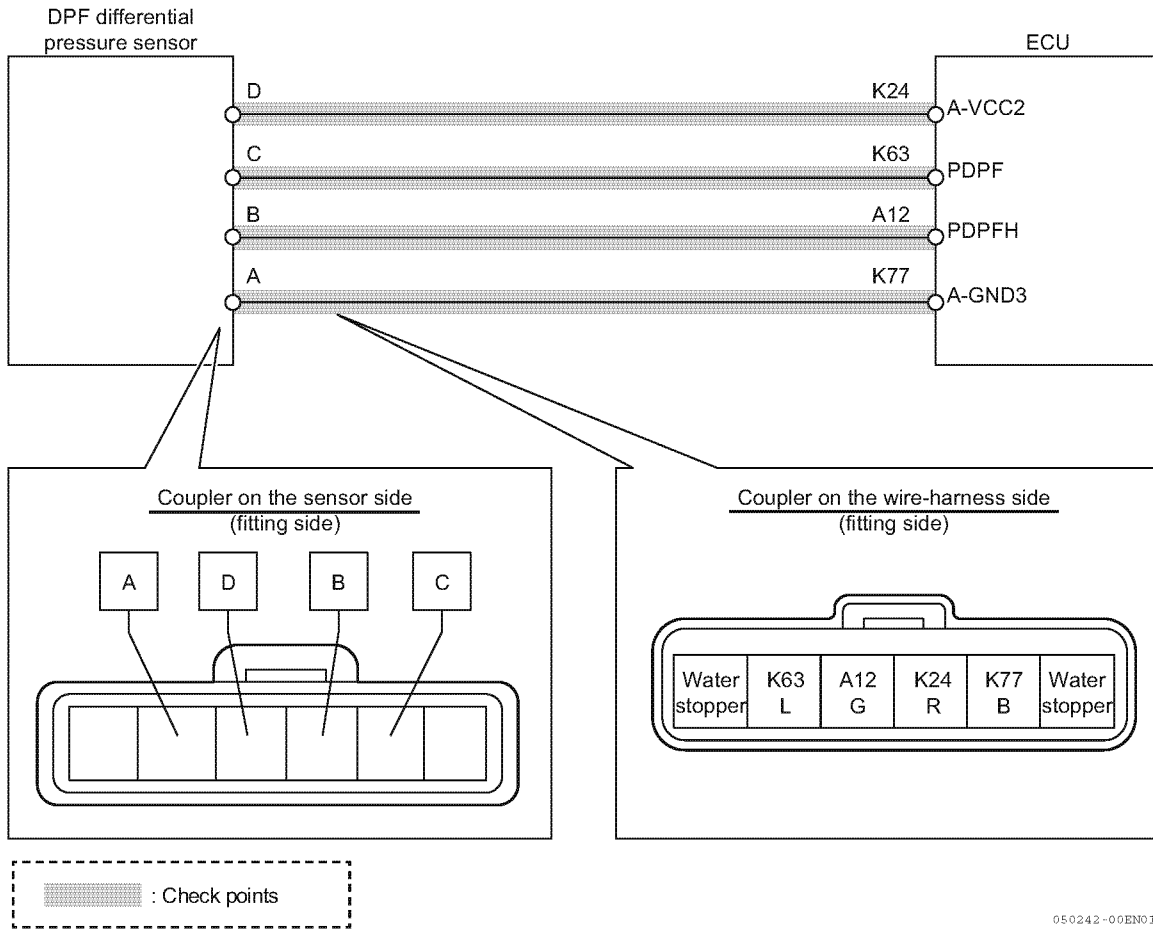

050242-00EN01

Note: See P325 for the ECU pin layout.

● Work description

1. Checking the ECU output voltage

- 1-Connect the checker harness between the ECU and engine wire-harness. Also, connect all connectors (sensor, wire-harness, ECU).
- 2-Using a circuit tester, measure the voltage between DPF differential pressure sensors 5 V K24 and K77.

Voltage	State	Corrective action
$K24 < 4.375 \text{ V}$	NG	<ul style="list-style-type: none"> • Replace the wire-harness. • Replace the ECU.
$4.375 \text{ V} \leq K24 \leq 5.625 \text{ V}$	OK (normal range)	Check the DPF differential pressure sensor output voltage.
$5.625 \text{ V} < K24$	NG	<ul style="list-style-type: none"> • Replace the wire-harness. • Replace the ECU.

NG	Replace the wire-harness or ECU, and turn off and on the key switch and perform the diagnosis using the SMARTASSIST-DIRECT (SA-D).
OK	Go to "Checking the DPF differential pressure sensor output voltage".

2. Checking the DPF differential pressure sensor output voltage

1-Connect the checker harness between the ECU and engine wire-harness. Also, connect all connectors (sensor, wire-harness, ECU).

2-Using a circuit tester, measure the voltage between the sensor signals K63 and K77.

Voltage	State	Corrective action
$K63 < 0.5 \text{ V}$	NG	<ul style="list-style-type: none"> • Replace the wire-harness. • Replace the ECU.
$0.5 \text{ V} \leq K63 \leq 4.5 \text{ V}$	OK (normal range)	Replace the ECU.
$4.5 \text{ V} < K63$	NG	<ul style="list-style-type: none"> • Replace the wire-harness. • Replace the ECU.

NG	Replace the wire-harness or ECU, and turn off and on the key switch and perform the diagnosis using the SMARTASSIST-DIRECT (SA-D).
OK	Replace the ECU.

3. Checking the DPF high pressure side pressure sensor output voltage

1-Connect the checker harness between the ECU and engine wire-harness. Also, connect all connectors (sensor, wire-harness, ECU).

2-Using a circuit tester, measure the voltage between the sensor signals A12 and K77.

Voltage	State	Corrective action
$A12 < 0.5 \text{ V}$	NG	<ul style="list-style-type: none"> • Replace the wire-harness. • Replace the ECU.
$0.5 \text{ V} \leq A12 \leq 4.5 \text{ V}$	OK (normal range)	Replace the ECU.

■ DPF inlet temperature sensor

● Related DTC

P code	SPN/FMI	Name
P1428	3242/3	DPF inlet temperature sensor error (voltage high)
P1427	3242/4	DPF inlet temperature sensor error (voltage low)
P167E	3242/10	DPF inlet temperature sensor error (detected value error)
P1436	3242/0	DPF inlet temperature sensor error (high temperature)

● Workflow

Note: See "Work description" for work details. Go to "SA-D Operation Manual" for the SA-D operation.

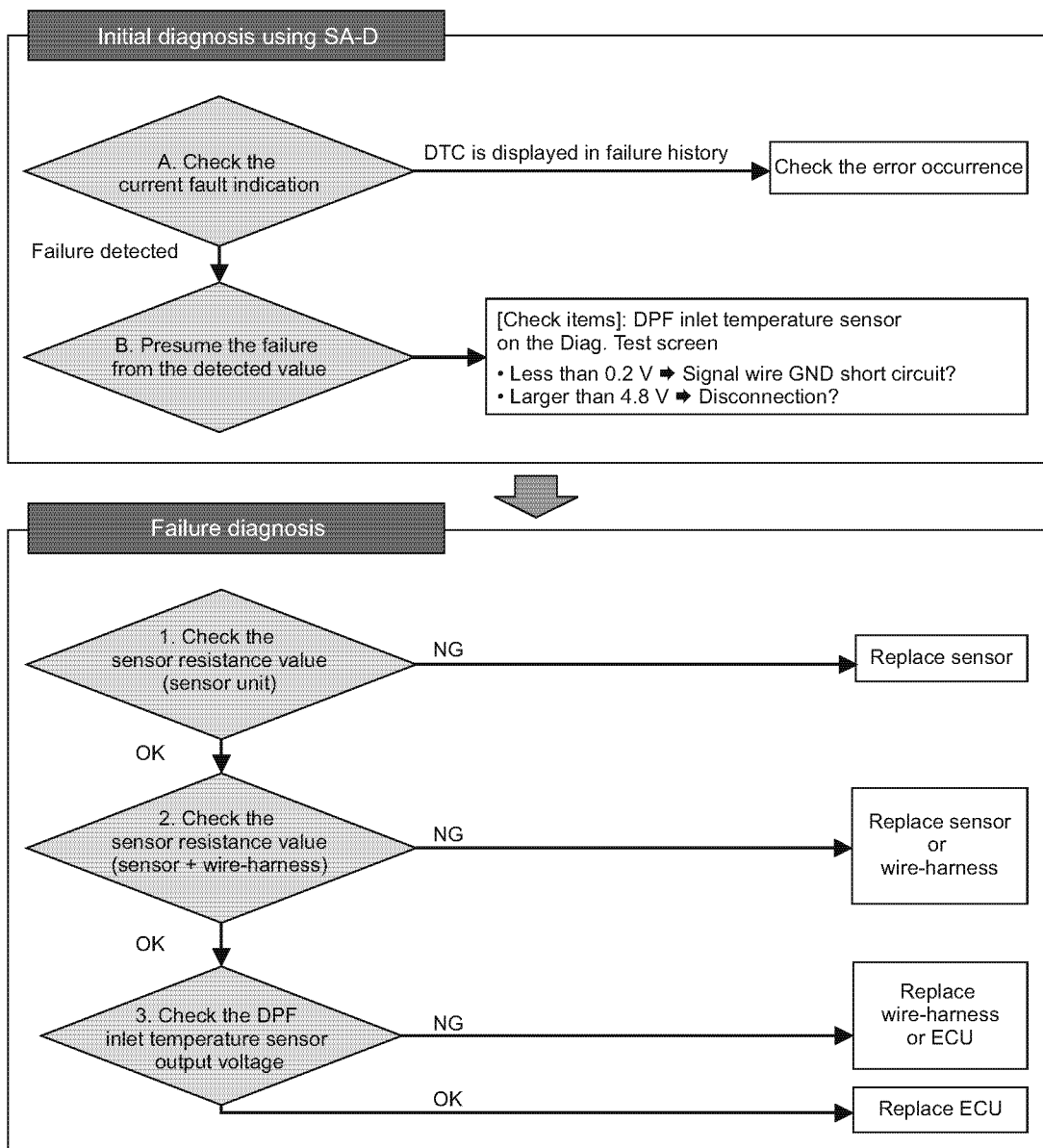

044366-01EN01

● Wire diagram

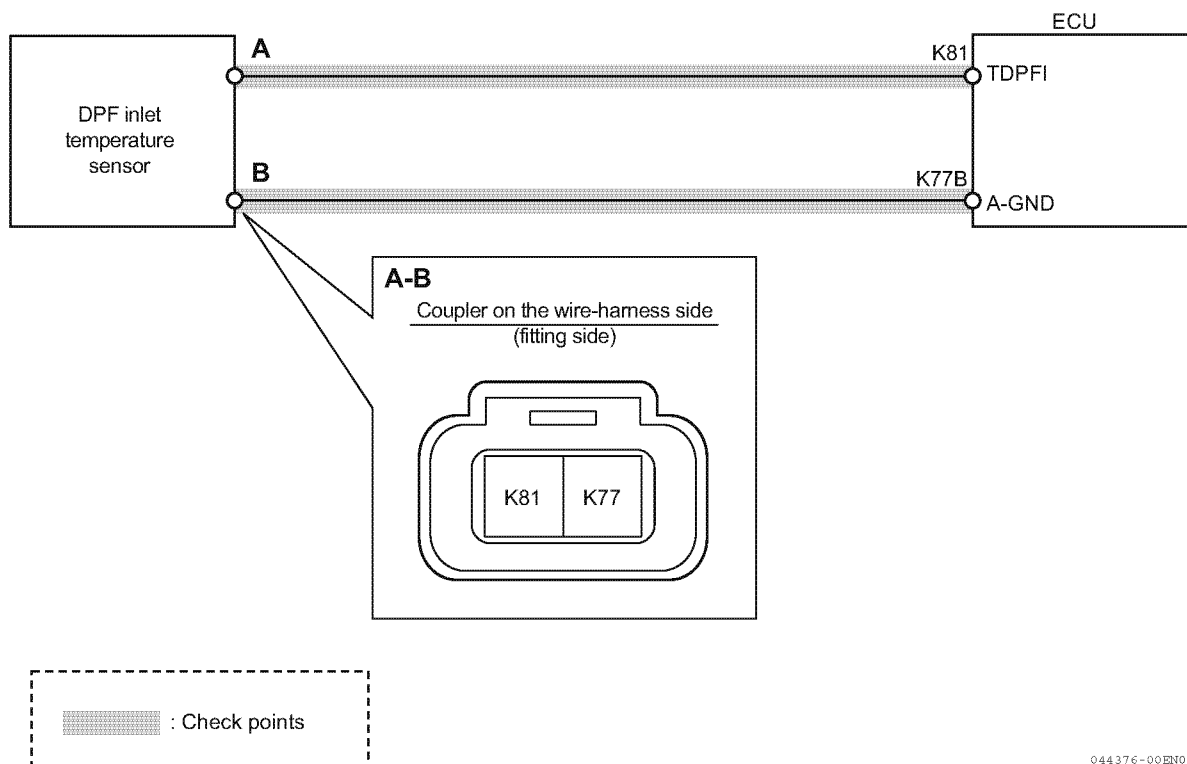

Note: See P325 for the ECU pin layout.

044376-00EN00

● **Work description**

1. Checking the sensor resistance value (sensor unit)

- 1-Remove the wire-harness from the DPF inlet temperature sensor.
- 2-Using a circuit tester, measure the resistance value between DPF inlet temperature sensor terminals A and B.
- 3-Using “DPF inlet temperature sensor characteristics”, make sure that the measured resistance value is within the normal range.

DPF inlet temperature sensor characteristics

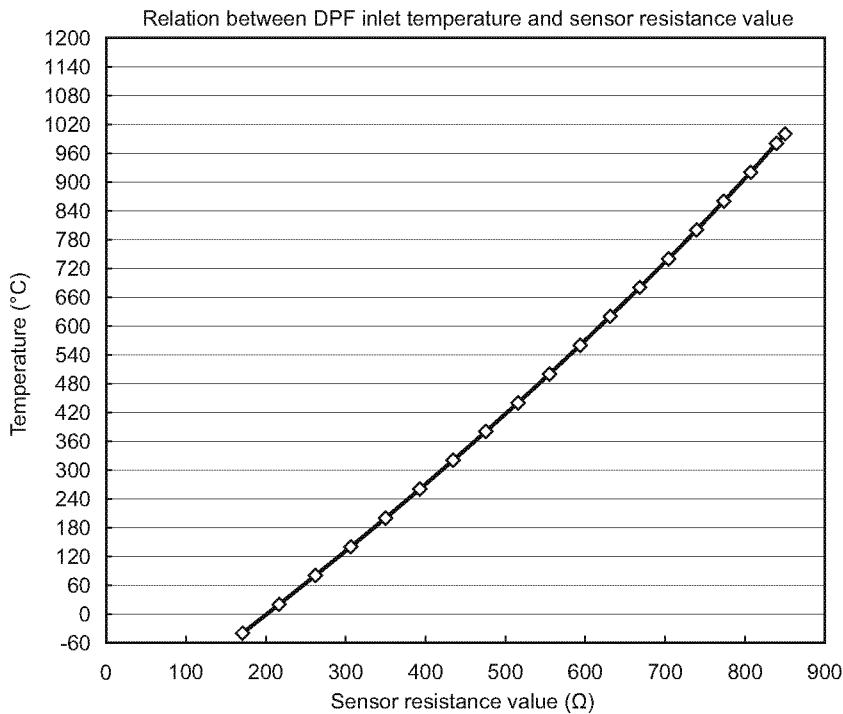

Temp. (°C)	Resistance[Ω]
-40	170.68
20	216.77
80	262.01
140	306.40
200	349.96
260	392.67
320	434.54
380	475.57
440	515.76
500	555.10
560	593.60
620	631.26
680	668.08
740	704.05
800	739.18
860	773.47
920	806.92
980	839.52
1000	850.20

044400-00EN00

NG	Replace the DPF inlet temperature sensor.
OK	Go to “Checking the sensor resistance value (sensor and wire-harness)”.

2. Checking the sensor resistance value (sensor and wire-harness)

- 1-Connect the DPF inlet temperature sensor and wire-harness then remove the ECU from the wire-harness.
- 2-Using a circuit tester, measure the resistance value between ECU connector terminals K81 and K77B on the wire-harness side.
- 3-Using “DPF inlet temperature sensor characteristics”, make sure that the measured resistance value is within the normal range.

NG	<ul style="list-style-type: none"> • The coupler between the sensor and the wire-harness may be defective. Replace the sensor. • Replace the wire-harness.
OK	Go to “Checking the DPF inlet temperature sensor output voltage”.

3. Checking the DPF inlet temperature sensor output voltage

1-Connect the checker harness between the ECU and engine wire-harness. Also connect all connectors (sensor, ECU).

2-Using a circuit tester, measure the voltage between DPF inlet temperature sensor signals K81 and K77B.

Voltage	State	Corrective action
$K81 < 0.2 \text{ V}$	NG	<ul style="list-style-type: none"> • Replace the wire-harness. • Replace the ECU.
$0.2 \text{ V} \leq K81 \leq 4.8 \text{ V}$	OK (normal range)	Replace the ECU.
$4.8 \text{ V} < K81$	NG	<ul style="list-style-type: none"> • Replace the wire-harness. • Replace the ECU.

NG	<ul style="list-style-type: none"> • The coupler between the wire-harness and the ECU may be defective. Replace the wire-harness. • Replace the ECU.
OK	Replace the ECU.

■ DPF intermediate temperature sensor

● Related DTC

P code	SPN/FMI	Name
P1434	3250/3	DPF intermediate temperature sensor error (voltage high)
P1435	3250/4	DPF intermediate temperature sensor error (voltage low)
P167A	3250/10	DPF intermediate temperature sensor error (detected value error)
P0420	3250/1	DPF intermediate temperature sensor temperature too low
P1426	3250/0	DPF intermediate temperature sensor temperature rise error (post-injection failure)

● Workflow

Note: See "Work description" for work details. Go to "SA-D Operation Manual" for the SA-D operation.

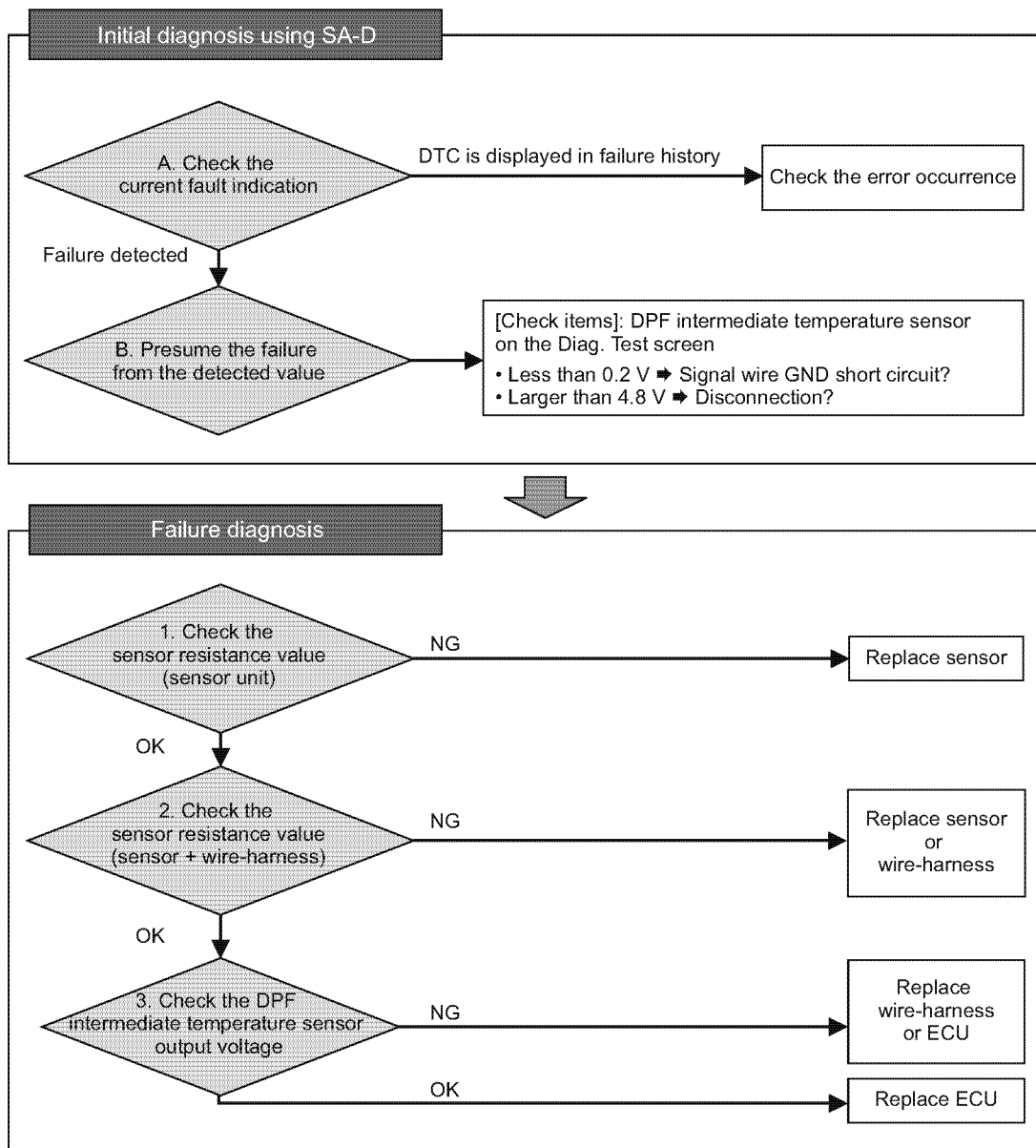

044387-01EN01

● Wire diagram

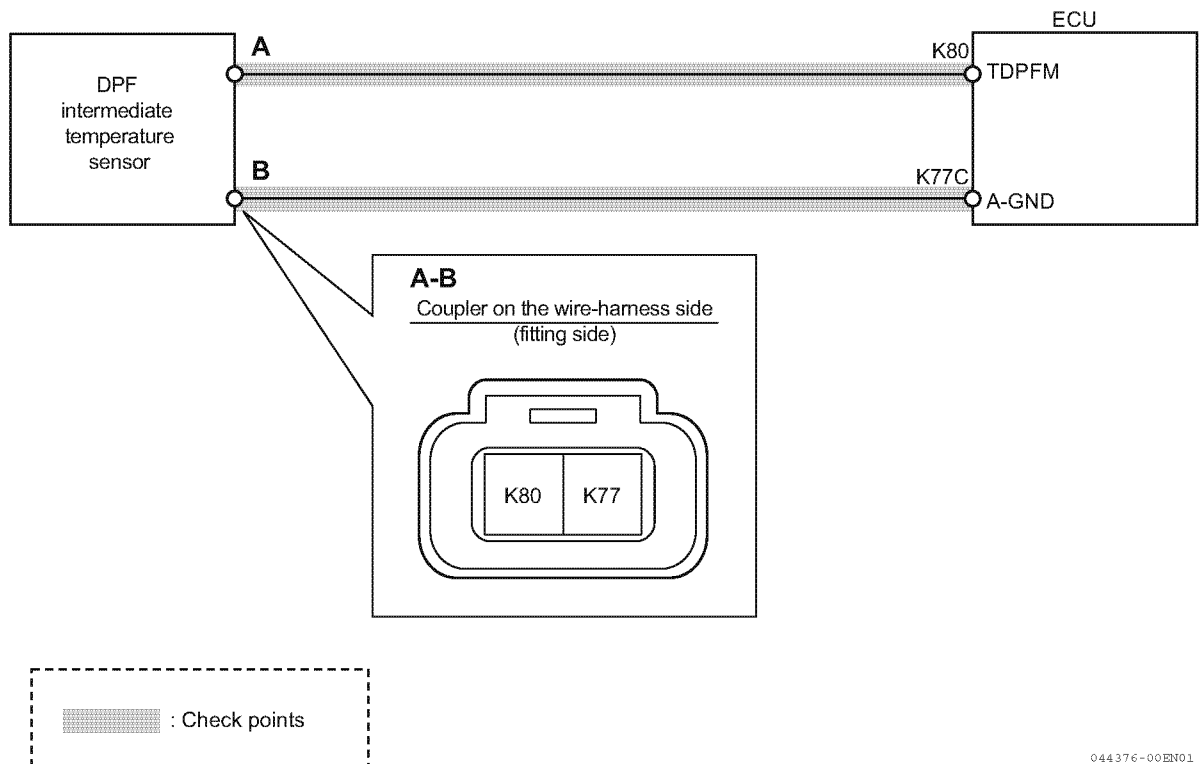

Note: See P325 for the ECU pin layout.

044376-00EN01

● **Work description**

1. Checking the sensor resistance value (sensor unit)

- 1-Remove the wire-harness from the DPF intermediate temperature sensor.
- 2-Using a circuit tester, measure the resistance value between DPF intermediate temperature sensor terminals A and B.
- 3-Using “DPF intermediate temperature sensor characteristics”, make sure that the measured resistance value is within the normal range.

DPF intermediate temperature sensor characteristics

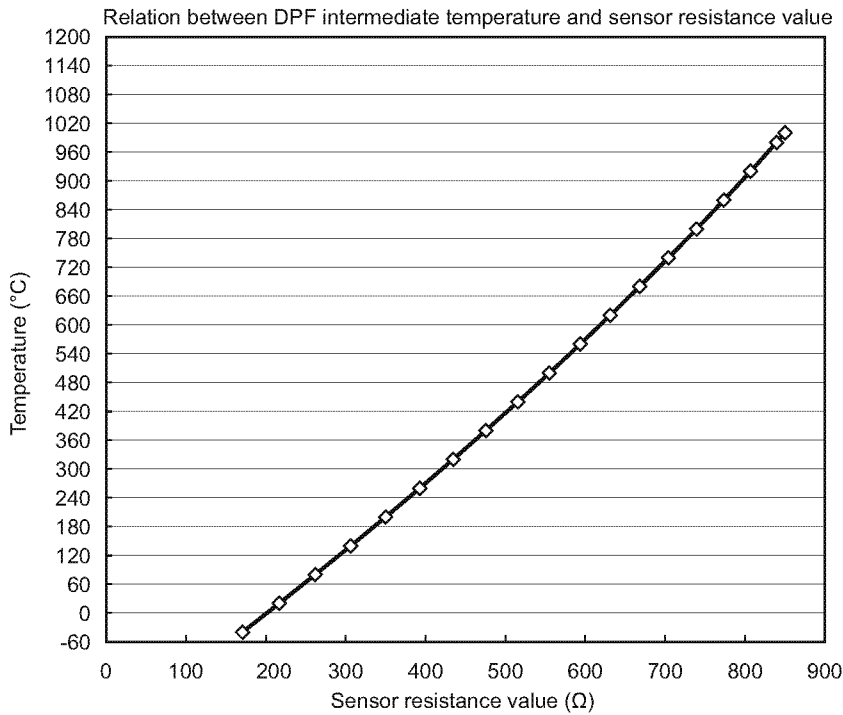

Temp. (°C)	Resistance[Ω]
-40	170.68
20	216.77
80	262.01
140	306.40
200	349.96
260	392.67
320	434.54
380	475.57
440	515.76
500	555.10
560	593.60
620	631.26
680	668.08
740	704.05
800	739.18
860	773.47
920	806.92
980	839.52
1000	850.20

044400-00EN01

NG	Replace the DPF intermediate temperature sensor.
OK	Go to “Checking the sensor resistance value (sensor and wire-harness)”.

2. Checking the sensor resistance value (sensor and wire-harness)

- 1-Connect the DPF intermediate temperature sensor and wire-harness, then remove the ECU from the wire-harness.
- 2-Using a circuit tester, measure the resistance value between ECU connector terminals K80 and K77C on the wire-harness side.
- 3-Using “DPF intermediate temperature sensor characteristics”, make sure that the measured resistance value is within the normal range.

NG	<ul style="list-style-type: none"> • The coupler between the sensor and the wire-harness may be defective. Replace the sensor. • Replace the wire-harness.
OK	Go to “Checking the DPF intermediate temperature sensor output voltage”.

3. Checking the DPF intermediate temperature sensor output voltage

- 1-Connect the checker harness between the ECU and engine wire-harness. Also connect all connectors (sensor, ECU).
- 2-Using a circuit tester, measure the voltage between DPF intermediate temperature sensor signals K80 and K77C.

Voltage	State	Corrective action
$K80 < 0.2 \text{ V}$	NG	<ul style="list-style-type: none"> • Replace the wire-harness. • Replace the ECU.
$0.2 \text{ V} \leq K80 \leq 4.8 \text{ V}$	OK (normal range)	Replace the ECU.
$4.8 \text{ V} < K80$	NG	<ul style="list-style-type: none"> • Replace the wire-harness. • Replace the ECU.

NG	<ul style="list-style-type: none"> • The coupler between the wire-harness and the ECU may be defective. Replace the wire-harness. • Replace the ECU.
OK	Replace the ECU.

■ EGR gas temperature sensor

● Related DTC

P code	SPN/FMI	Name
P041D	412/3	EGR gas temperature sensor error (voltage high)
P041C	412/4	EGR gas temperature sensor error (voltage low)

● Workflow

Note: See "Work description" for work details. Go to "SA-D Operation Manual" for the SA-D operation.

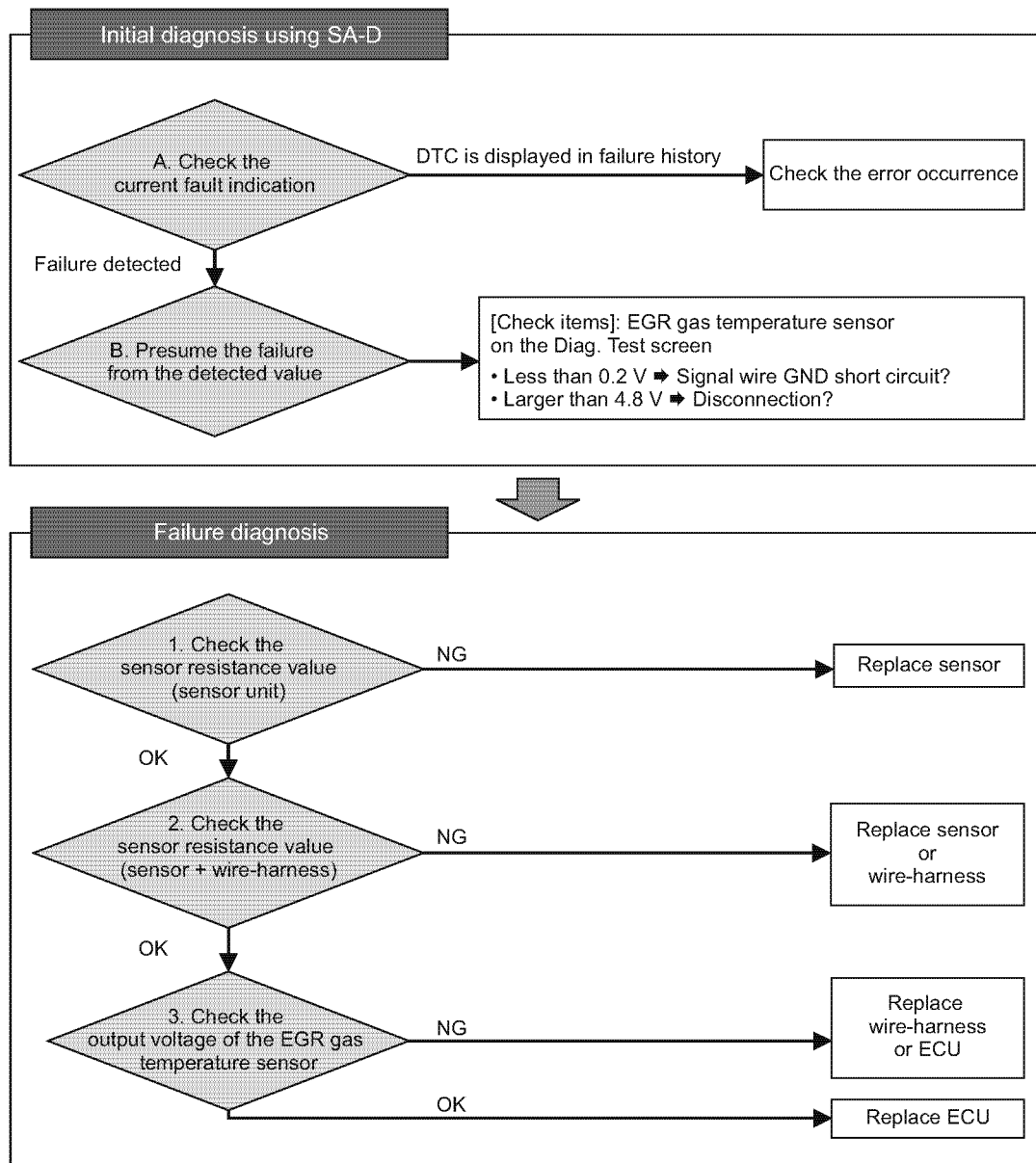

044388-01EN01

● Wire diagram

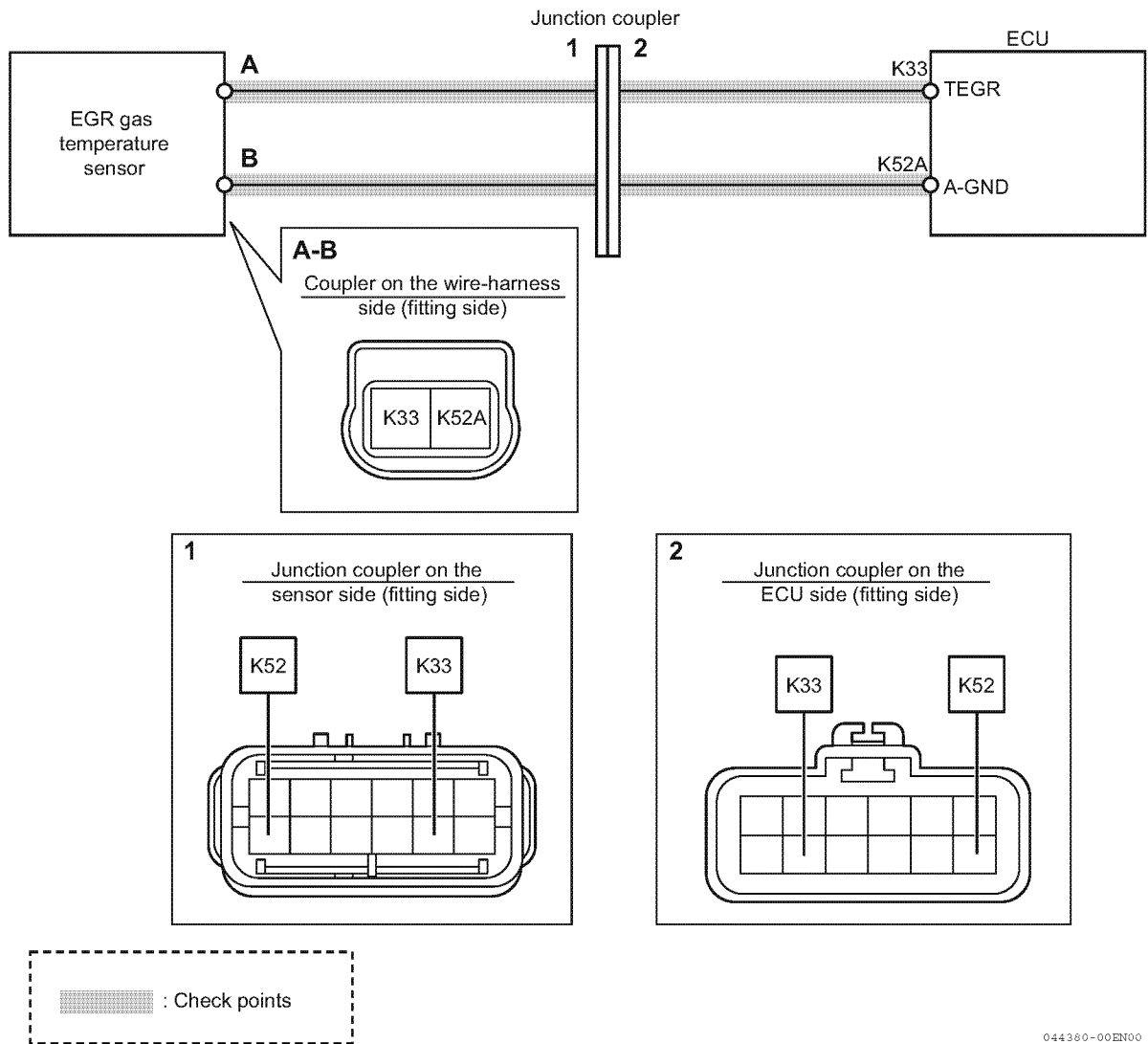

044380-00EN00

Note: See P325 for the ECU pin layout.

● Work description

1. Checking the sensor resistance value (sensor unit)

- 1-Remove the wire-harness from the EGR gas temperature sensor.
- 2-Using a circuit tester, measure the resistance value between EGR gas temperature sensor terminals A and B.
- 3-Using “EGR gas temperature sensor characteristics”, make sure that the measured resistance value is within the normal range.

EGR gas temperature sensor characteristic

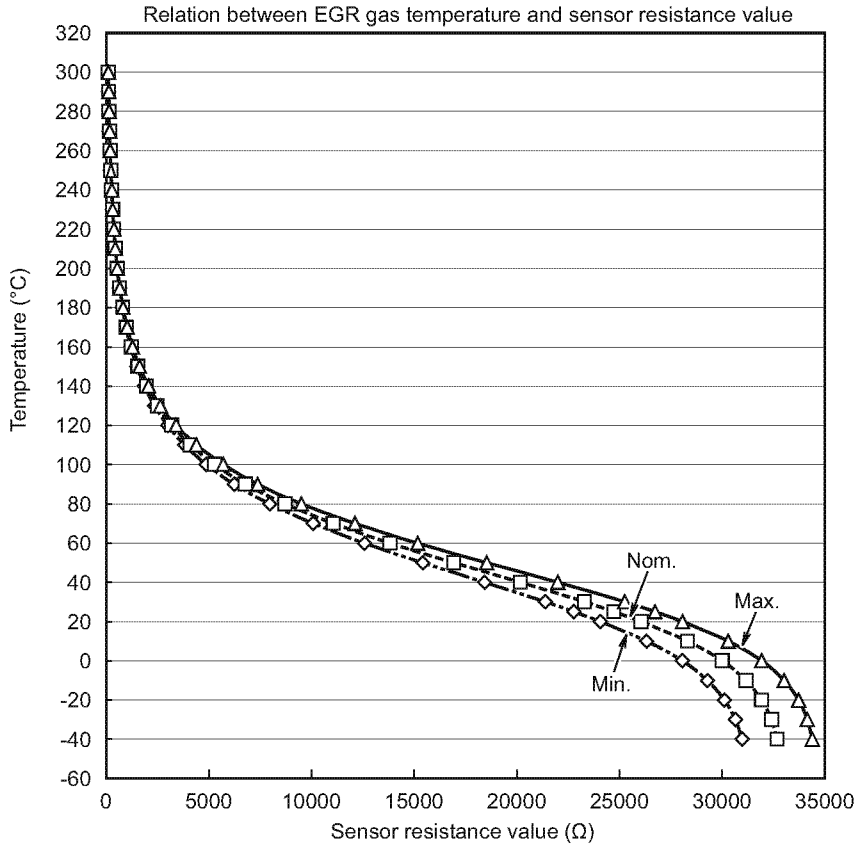

Temperature (°C)	Sensor resistance value (Ω)		
	Min.	Nom.	Max.
-40	30968	32683	34388
-30	30647	32402	34144
-20	30117	31926	33719
-10	29286	31159	33019
0	28057	29995	31927
10	26319	28308	30298
20	24067	26055	28069
25	22771	24727	26728
30	21380	23288	25253
40	18422	20169	21995
50	15421	16936	18541
60	12590	13838	15172
70	10081	11062	12120
80	7966	8708	9511
90	6245	6794	7385
100	4881	5277	5702
110	3816	4098	4398
120	2992	3191	3401
130	2357	2496	2641
140	1869	1964	2063
150	1491	1555	1623
160	1197	1241	1286
170	968.7	996.9	1026.7
180	789.3	807.5	826.0
190	647.7	658.6	669.6
200	535.2	541.0	546.7
210	440.2	447.4	454.7
220	364.6	372.5	380.6
230	303.9	312.1	320.5
240	255.0	263.2	271.6
250	215.2	223.2	231.3
260	182.7	190.3	198.3
270	156.0	163.2	170.8
280	133.8	140.7	147.8
290	115.5	121.8	128.5
300	100.1	106.1	112.2

044401-00EN00

NG	Replace the EGR gas temperature sensor.
OK	Go to “Checking the sensor resistance value (sensor and wire-harness)”.

2. Checking the sensor resistance value (sensor and wire-harness)

- 1- Connect the EGR gas temperature sensor and the wire-harness, and then remove the ECU from the wire-harness.
- 2- Using a circuit tester, measure the resistance value between the ECU side wire-harness connector terminals K33 and K52A.
- 3- Using "EGR gas temperature sensor characteristics", make sure that the measured resistance value is within the normal range.

NG	<ul style="list-style-type: none"> • The coupler between the sensor and the wire-harness may be defective. Replace the sensor. • Replace the wire-harness.
OK	Go to "Checking the output voltage of the EGR gas temperature sensor".

3. Checking the output voltage of the EGR gas temperature sensor

- 1- Connect the checker harness between the ECU and engine wire-harness. Also connect all connectors (sensor, ECU).
- 2- Using a circuit tester, measure the voltage between EGR gas temperature sensor signals K33 and K52A.

Voltage	State	Corrective action
$K33 < 0.2 \text{ V}$	NG	<ul style="list-style-type: none"> • Replace the wire-harness. • Replace the ECU.
$0.2 \text{ V} \leq K33 \leq 4.8 \text{ V}$	OK (normal range)	Replace the ECU.
$4.8 \text{ V} < K33$	NG	<ul style="list-style-type: none"> • Replace the wire-harness. • Replace the ECU.

NG	<ul style="list-style-type: none"> • The coupler between the wire-harness and the ECU may be defective. Replace the wire-harness. • Replace the ECU.
OK	Replace the ECU.

● Related DTC

P code	SPN/FMI	Name
P1675	412/10	EGR gas temperature sensor error (detected value error)

● Workflow

Note: See "Work description" for work details. Go to "SA-D Operation Manual" for the SA-D operation.

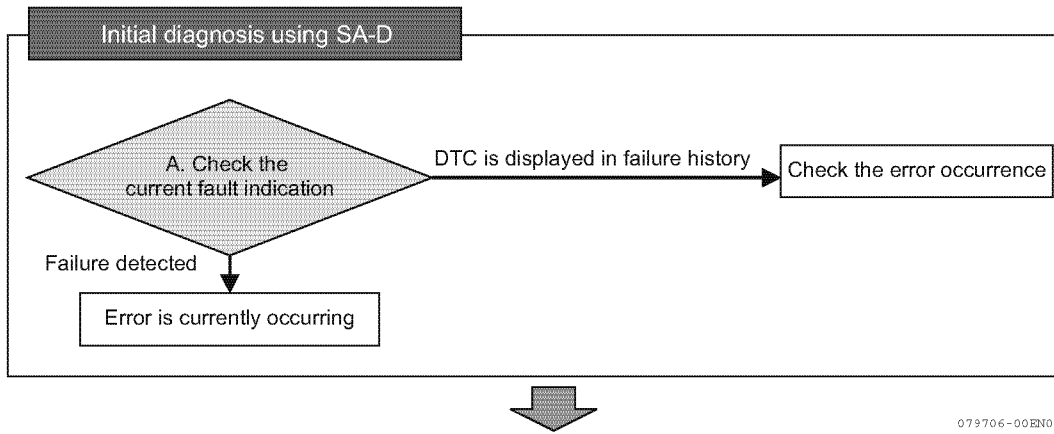

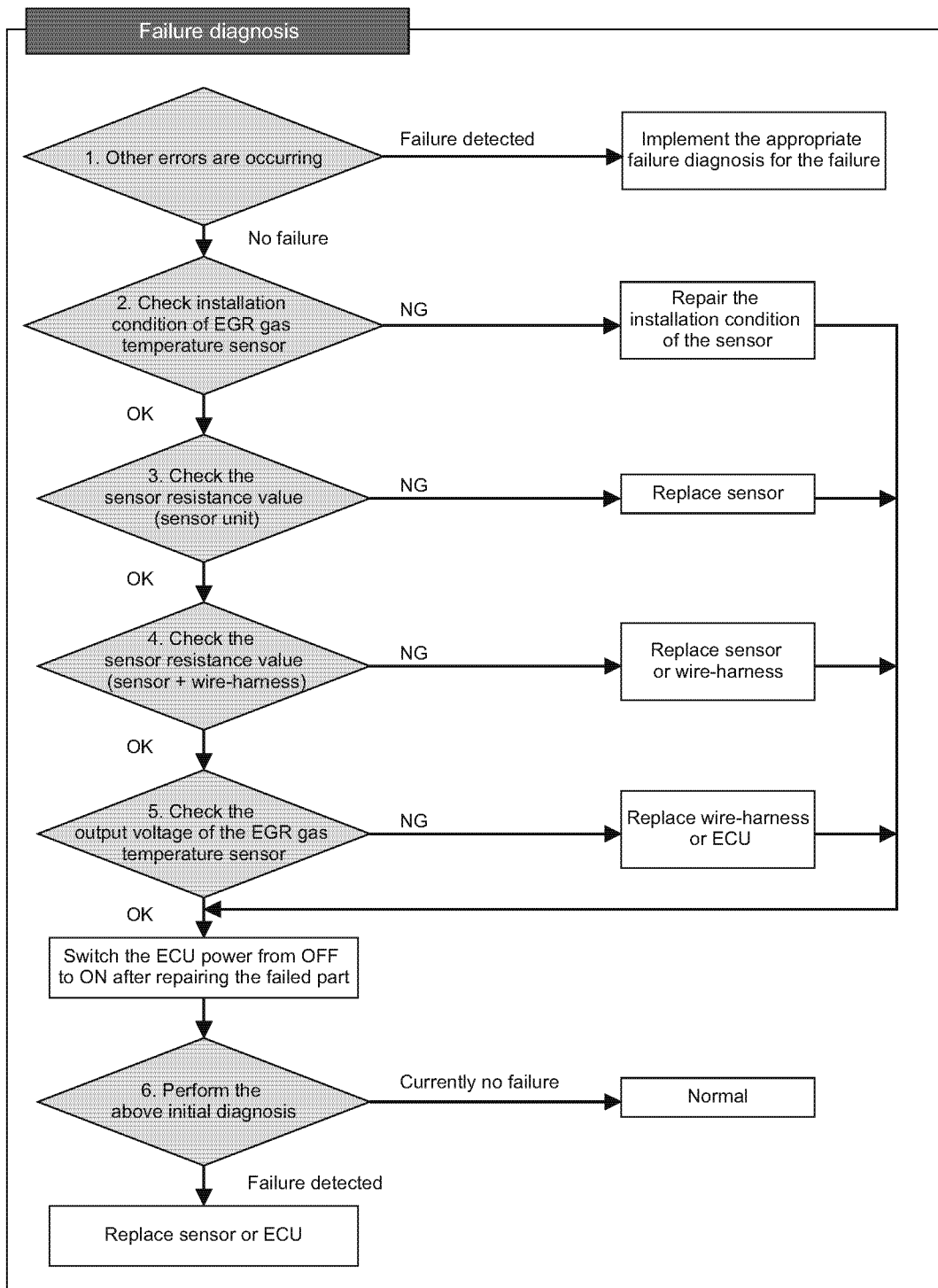

079723-00EN02

● Wire diagram

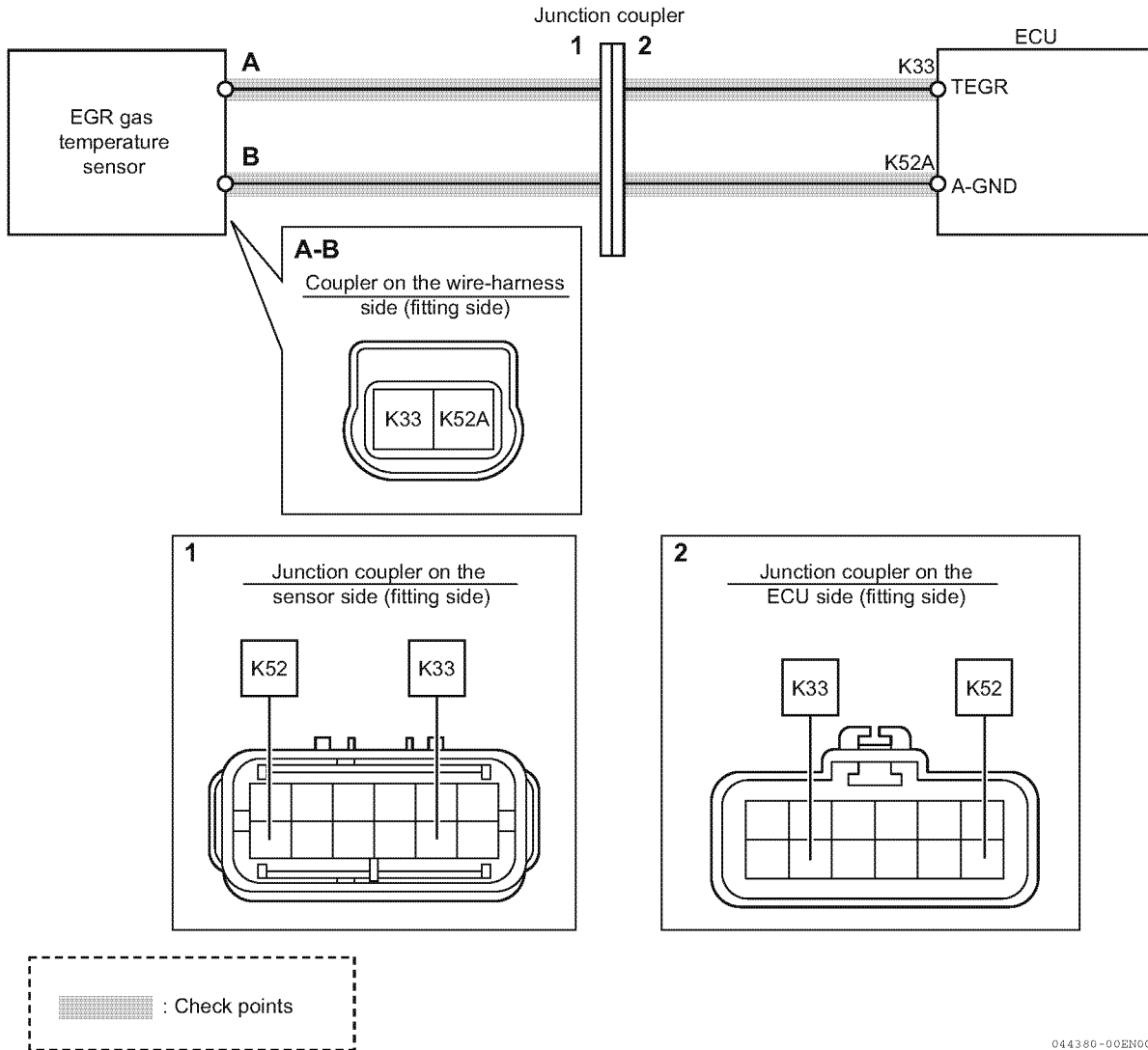

Note: See P325 for the ECU pin layout.

● Work description

1. Checking for other errors

- 1- Turn off the key switch and turn on the key switch again.
- 2- Connect the SA-D and check the current fault indication to see whether any other errors are detected. Particularly, check to see whether any errors are detected for EGR gas temperature sensor, engine coolant temperature sensor, DPF inlet temperature sensor, EGR valve, or inside the ECU.

Error detected	Implement the appropriate failure diagnosis for the failure.
No error detected	Go to "Checking installation condition of EGR gas temperature sensor".

2. Checking installation condition of EGR gas temperature sensor

- 1- Turn off the key switch.
- 2- Check the installation condition of EGR gas temperature sensor.
- 3- Check the EGR pipe and EGR cooler for damage or failure.

NG	Reinstall the sensor, and turn off/on the ECU power for failure diagnosis using SA-D.
OK	Go to "Checking the sensor resistance value (sensor unit)".

3. Checking the sensor resistance value (sensor unit)

- 1- Remove the wire-harness from the EGR gas temperature sensor.
- 2- Using a circuit tester, measure the resistance value between EGR gas temperature sensor terminals A and B.
- 3- Using "EGR gas temperature sensor characteristics", make sure that the measured resistance value is within the normal range.

EGR gas temperature sensor characteristics

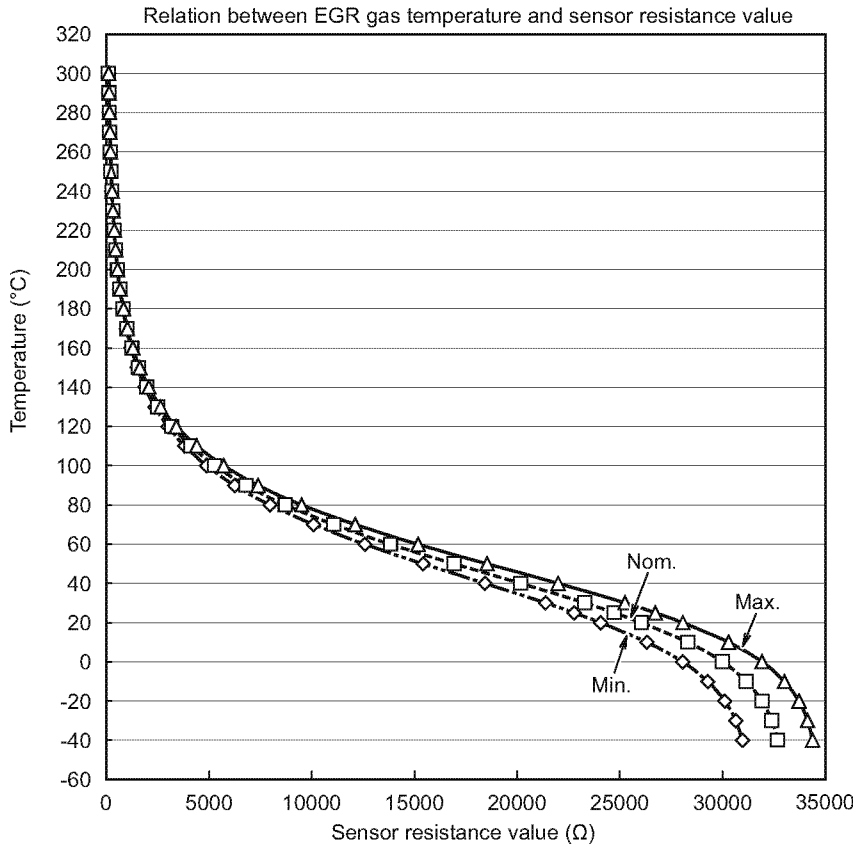

Temperature (°C)	Sensor resistance value (Ω)		
	Min.	Nom.	Max.
-40	30968	32683	34388
-30	30647	32402	34144
-20	30117	31926	33719
-10	29286	31159	33019
0	28057	29995	31927
10	26319	28308	30298
20	24067	26055	28069
25	22771	24727	26728
30	21380	23288	25253
40	18422	20169	21995
50	15421	16936	18541
60	12590	13838	15172
70	10081	11062	12120
80	7966	8708	9511
90	6245	6794	7385
100	4881	5277	5702
110	3816	4098	4398
120	2992	3191	3401
130	2357	2496	2641
140	1869	1964	2063
150	1491	1555	1623
160	1197	1241	1286
170	968.7	996.9	1026.7
180	789.3	807.5	826.0
190	647.7	658.6	669.6
200	535.2	541.0	546.7
210	440.2	447.4	454.7
220	364.6	372.5	380.6
230	303.9	312.1	320.5
240	255.0	263.2	271.6
250	215.2	223.2	231.3
260	182.7	190.3	198.3
270	156.0	163.2	170.8
280	133.8	140.7	147.8
290	115.5	121.8	128.5
300	100.1	106.1	112.2

044401-00EN00

NG	Replace the EGR gas temperature sensor, and switch the ECU power from OFF to ON for failure diagnosis using SA-D.
OK	Go to "Checking the sensor resistance value (sensor and wire-harness)".

4. Checking the sensor resistance value (sensor and wire-harness)

- 1-Connect the EGR gas temperature sensor and the wire-harness, and then remove the ECU from the wire-harness.
- 2-Using a circuit tester, measure the resistance value between ECU connector terminals K33 and K52A on the wire-harness side.
- 3-Using "EGR gas temperature sensor characteristics", make sure that the measured resistance value is within the normal range.

NG	<ul style="list-style-type: none"> • The coupler between the sensor and the wire-harness may be defective. Replace the sensor. • Replace the wire-harness. Switch the ECU power from OFF to ON for failure diagnosis using SA-D after replacement.
OK	Go to "Checking the output voltage of the EGR gas temperature sensor".

5. Checking the output voltage of the EGR gas temperature sensor

- 1-Connect the checker harness between the ECU and engine wire-harness. Also connect all connectors (sensor, ECU).
- 2-Using a circuit tester, measure the voltage between EGR gas temperature sensor signals K33 and K52A.

Voltage	State	Corrective action
$K33 < 0.15 \text{ V}$	NG	<ul style="list-style-type: none"> • Replace the wire-harness. • Replace the ECU.
$0.15 \text{ V} \leq K33 \leq 4.8 \text{ V}$	OK (normal range)	Perform failure diagnosis using SA-D.
$4.8 \text{ V} < K33$	NG	<ul style="list-style-type: none"> • Replace the wire-harness. • Replace the ECU.

NG	<ul style="list-style-type: none"> • The coupler between the wire-harness and the ECU may be defective. Replace the wire-harness. • Replace the ECU. Switch the ECU power from OFF to ON for failure diagnosis using SA-D after replacement.
OK	Switch the ECU power from OFF to ON for failure diagnosis using SA-D.

6. Operation using SA-D

- 1-Turn off the key switch and turn on the key switch again to start the engine. Operate the engine that satisfies the reset criteria for P1675: EGR gas temperature sensor error (detected value error) (*P121*).
- 2-Connect the SA-D and check the current fault indication to see whether an error is detected.

No	Normal
Yes	Replace the EGR gas temperature sensor or ECU.

■ Intake manifold temperature sensor

● Related DTC

P code	SPN/FMI	Name
P040D	105/3	Intake manifold temperature sensor error (voltage high)
P040C	105/4	Intake manifold temperature sensor error (voltage low)

● Workflow

Note: See "Work description" for work details. Go to "SA-D Operation Manual" for the SA-D operation.

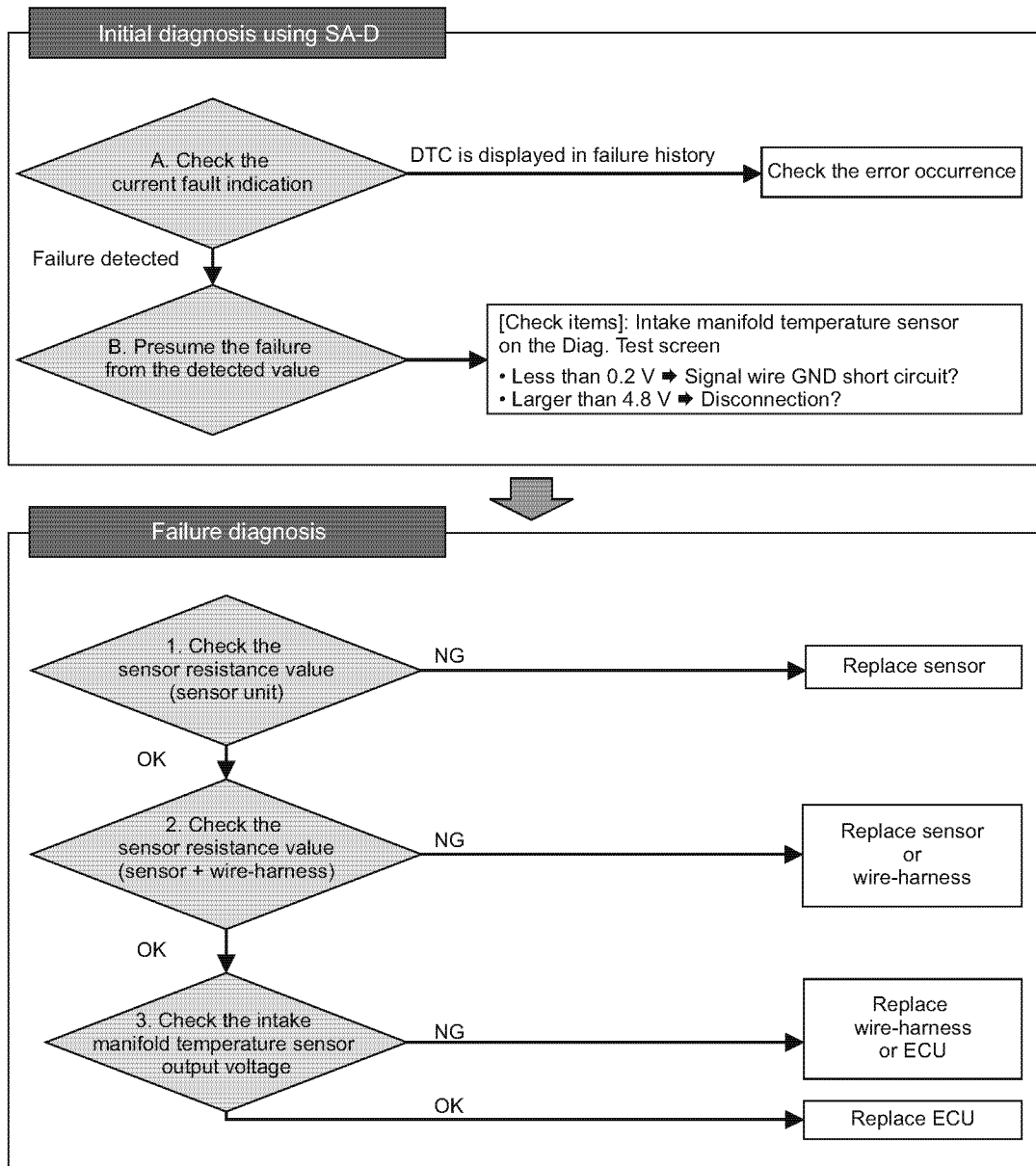

044389-01EN02

● Wire diagram

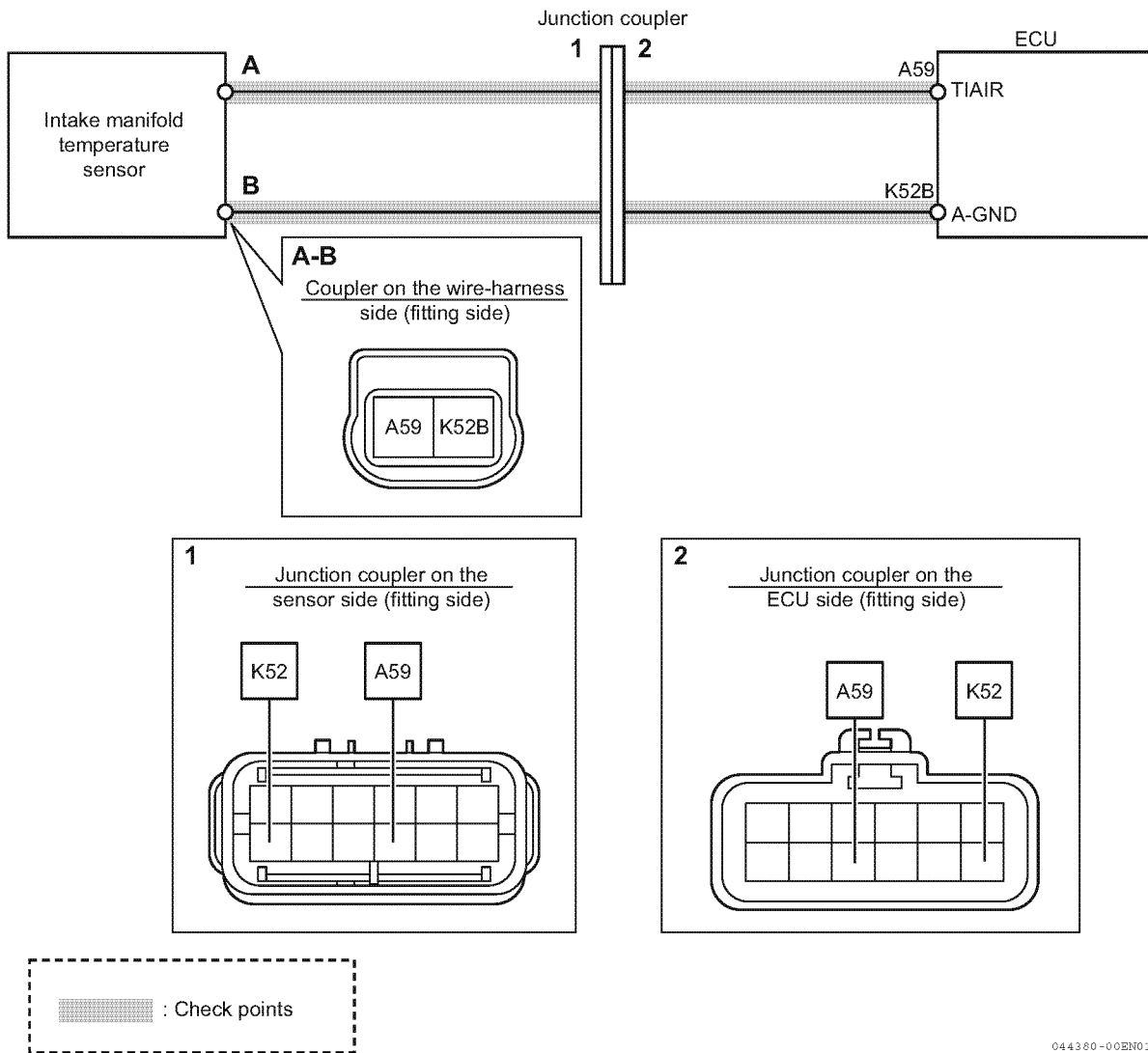

Note: See P325 for the ECU pin layout.

044380-00EN01

● Work description

1. Checking the sensor resistance value (sensor unit)

- 1- Remove the wire-harness from the intake manifold temperature sensor.
- 2- Using a circuit tester, measure the resistance value between intake manifold temperature sensor terminals A and B.
- 3- Using "Intake manifold temperature sensor characteristics", make sure that the measured resistance value is within the normal range.

Intake manifold temperature sensor characteristics

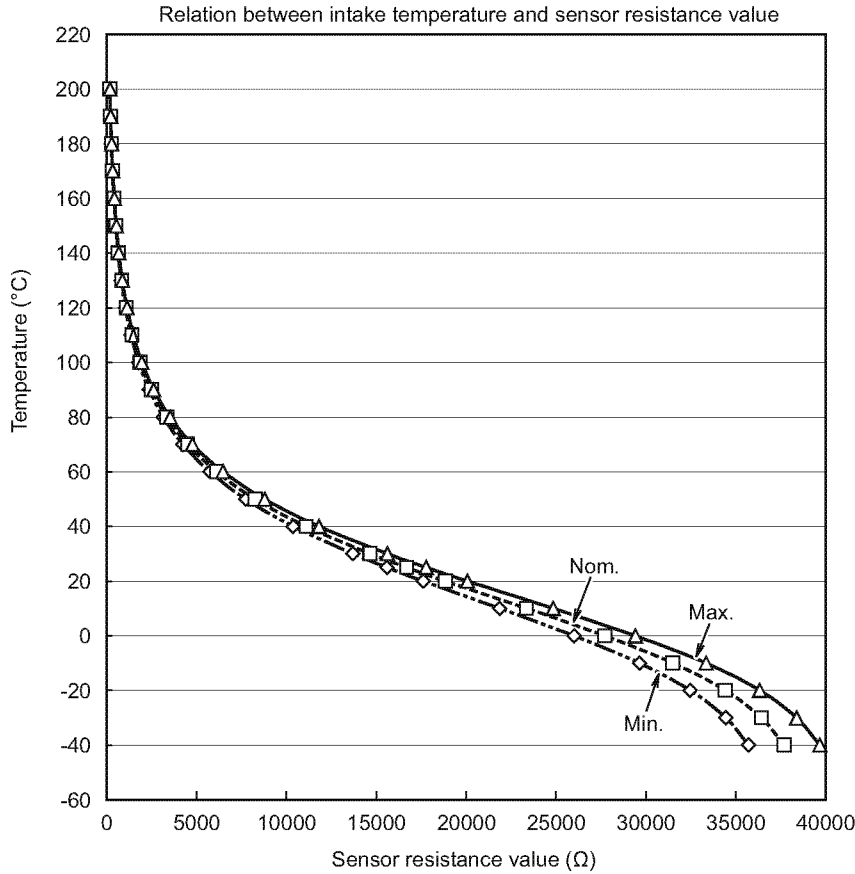

Temp. (°C)	Resistance[Ω]		
	Min.	Nom.	Max.
-40	35699	37683	39656
-30	34434	36412	38374
-20	32455	34400	36325
-10	29633	31496	33339
0	26009	27723	29420
10	21858	23354	24838
20	17614	18847	20073
25	15595	16691	17782
30	13701	14664	15623
40	10386	11106	11825
50	7750	8273	8795
60	5742	6116	6488
70	4252	4516	4780
80	3162	3347	3534
90	2366	2499	2631
100	1787	1881	1975
110	1362	1431	1498
120	1050	1098	1148
130	816.2	852.3	888.3
140	641.2	667.8	694.6
150	508.9	528.5	548.1
160	405.3	422.1	438.9
170	325.9	340.2	354.4
180	264.4	276.5	288.7
190	216.2	226.6	236.9
200	178.2	187.1	196.1

044402-00EN00

NG	Replace the intake manifold temperature sensor.
OK	Go to "Checking the sensor resistance value (sensor and wire-harness)".

2. Checking the sensor resistance value (sensor and wire-harness)

- 1-Connect the intake manifold temperature sensor and wire-harness, then remove the ECU from the wire-harness.
- 2-Using a circuit tester, measure the resistance value between the ECU side wire harness connector terminals K59 and K52B.
- 3-Using "Intake manifold temperature sensor characteristics", make sure that the measured resistance value is within the normal range.

NG	<ul style="list-style-type: none"> • The coupler between the sensor and the wire-harness may be defective. Replace the sensor. • Replace the wire-harness.
OK	Go to "Checking the intake manifold temperature sensor output voltage".

3. Checking the intake manifold temperature sensor output voltage

- 1-Connect the checker harness between the ECU and engine wire-harness. Also connect all connectors (sensor, ECU).
- 2-Using a circuit tester, measure the voltage between intake manifold temperature sensor signals A59 and K52B.

Voltage	State	Corrective action
$A59 < 0.2 \text{ V}$	NG	<ul style="list-style-type: none"> • Replace the wire-harness. • Replace the ECU.
$0.2 \text{ V} \leq A59 \leq 4.8 \text{ V}$	OK (normal range)	Replace the ECU.
$4.8 \text{ V} < A59$	NG	<ul style="list-style-type: none"> • Replace the wire-harness. • Replace the ECU.

NG	<ul style="list-style-type: none"> • The coupler between the wire-harness and the ECU may be defective. Replace the wire-harness. • Replace the ECU.
OK	Replace the ECU.

● Related DTC

P code	SPN/FMI	Name
P1676	105/10	Intake manifold temperature sensor error (detected value error)

● Workflow

Note: See "Work description" for work details. Go to "SA-D Operation Manual" for the SA-D operation.

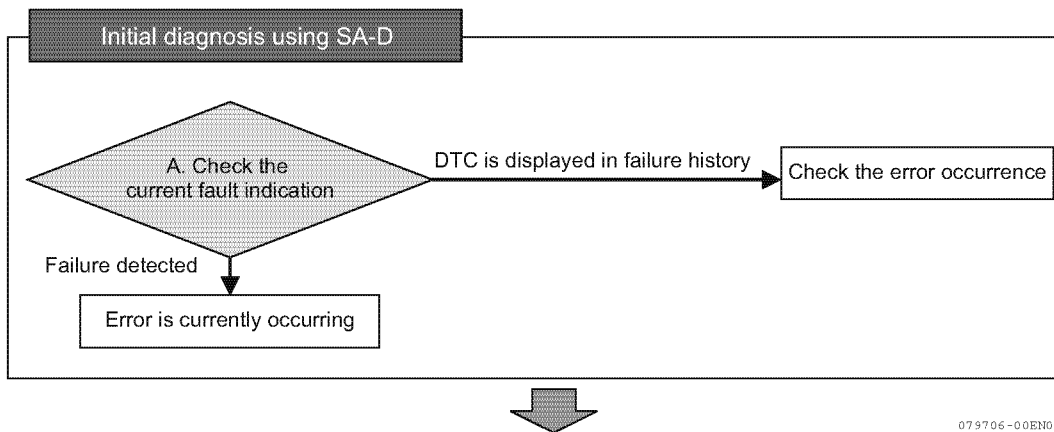

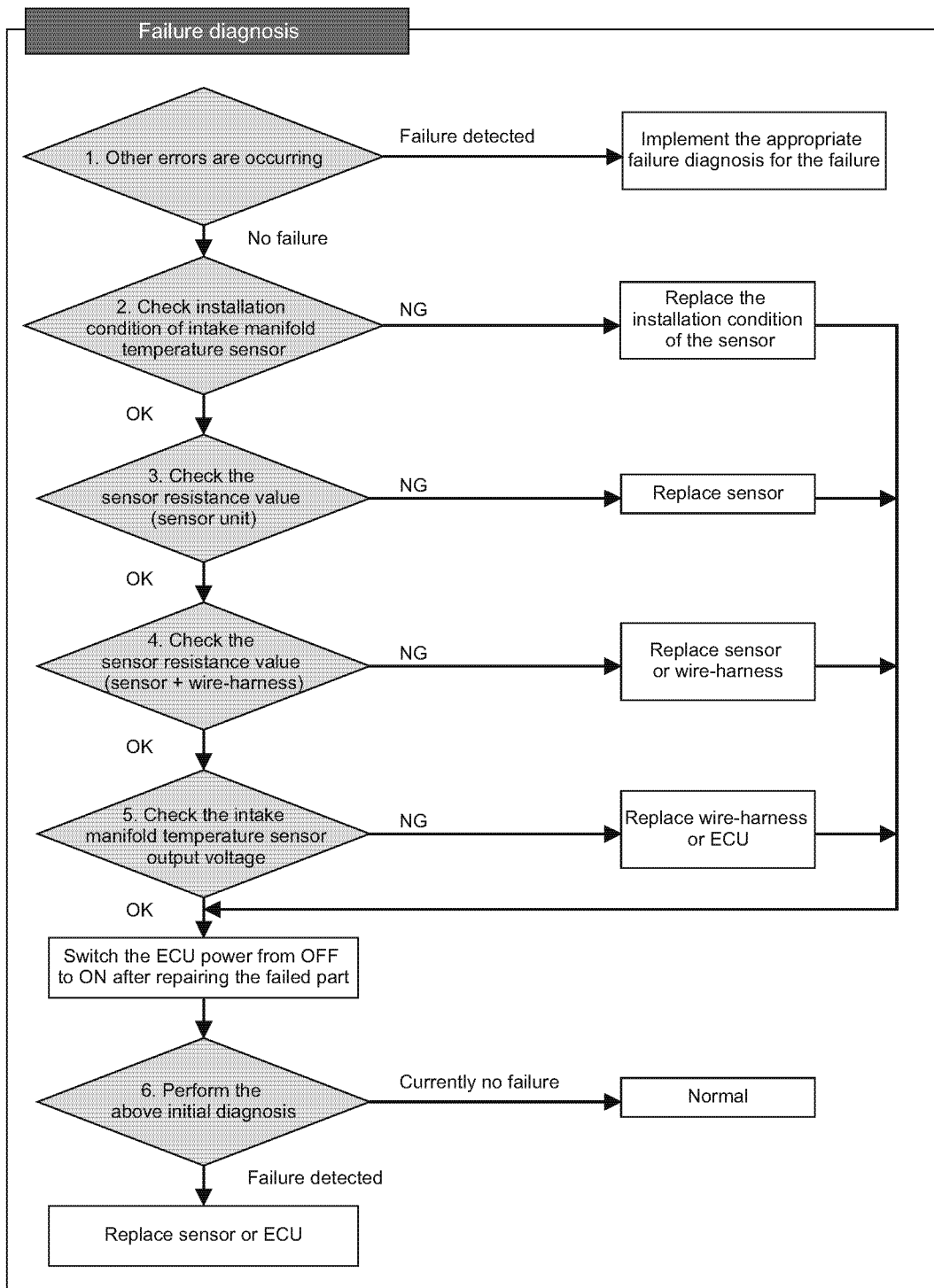

079723-00EN03

● Wire diagram

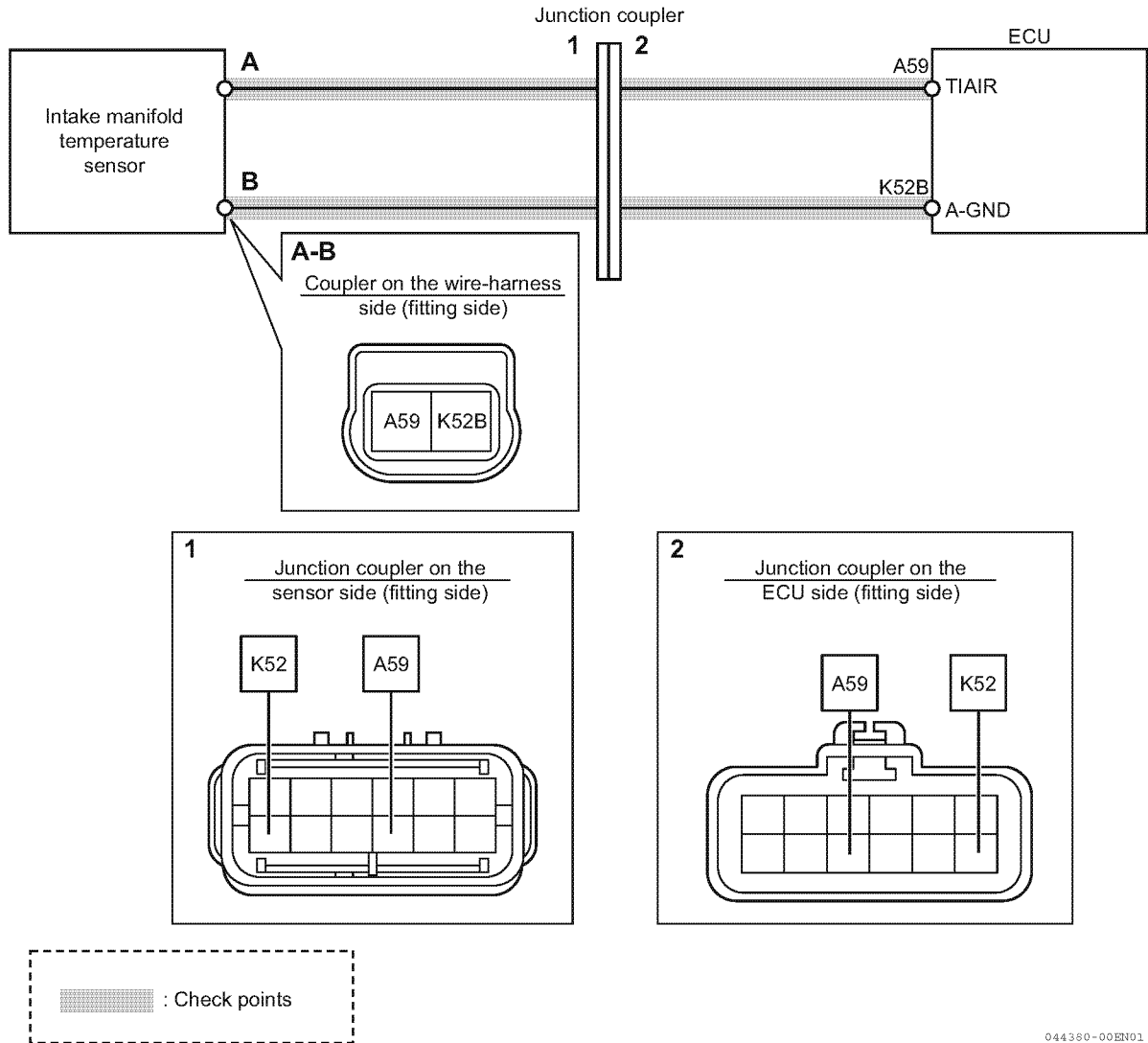

044380-00EN01

Note: See P325 for the ECU pin layout.

● Work description

1. Checking for other errors

- 1-Turn off the key switch and turn on the key switch again.
- 2-Connect the SA-D and check the current fault indication to see whether any other errors are detected. Particularly, check to see whether any errors are detected for intake manifold temperature sensor, engine coolant temperature sensor, ambient air temperature sensor, or inside the ECU.

Error detected	Implement the appropriate failure diagnosis for the failure.
No error detected	Go to "Checking installation condition of intake manifold temperature sensor".

2. Checking installation condition of intake manifold temperature sensor

- 1-Turn off the key switch.
- 2-Check the installation condition of intake manifold temperature sensor.

NG	Reinstall the sensor, and turn off/on the ECU power for failure diagnosis using SA-D.
OK	Go to "Checking the sensor resistance value (sensor unit)"

3. Checking the sensor resistance value (sensor unit)

- 1-Remove the wire-harness from the intake manifold temperature sensor.
- 2-Using a circuit tester, measure the resistance value between intake manifold temperature sensor terminals A and B.
- 3-Using "Intake manifold temperature sensor characteristics", make sure that the measured resistance value is within the normal range.

Intake manifold temperature sensor characteristics

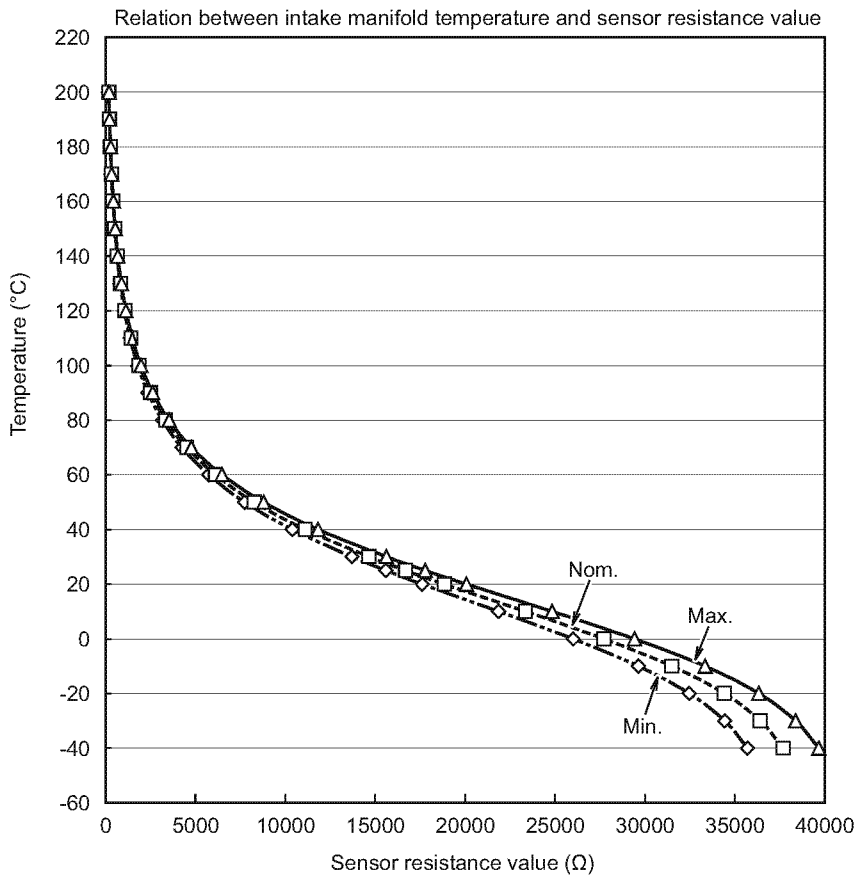

Temperature (°C)	Sensor resistance value (Ω)		
	Min.	Nom.	Max.
-40	35699	37683	39656
-30	34434	36412	38374
-20	32455	34400	36325
-10	29633	31496	33339
0	26009	27723	29420
10	21858	23354	24838
20	17614	18847	20073
25	15595	16691	17782
30	13701	14664	15623
40	10386	11106	11825
50	7750	8273	8795
60	5742	6116	6488
70	4252	4516	4780
80	3162	3347	3534
90	2366	2499	2631
100	1787	1881	1975
110	1362	1431	1498
120	1050	1098	1148
130	816.2	852.3	888.3
140	641.2	667.8	694.6
150	508.9	528.5	548.1
160	405.3	422.1	438.9
170	325.9	340.2	354.4
180	264.4	276.5	288.7
190	216.2	226.6	236.9
200	178.2	187.1	196.1

044402-00EN01

NG	Replace the intake manifold temperature sensor, and switch the ECU power from OFF to ON for failure diagnosis using SA-D.
OK	Go to "Checking the sensor resistance value (sensor and wire-harness)".

4. Checking the sensor resistance value (sensor and wire-harness)

- 1- Connect the intake manifold temperature sensor and wire-harness, then remove the ECU from the wire-harness.
- 2- Using a circuit tester, measure the resistance value between ECU connector terminals A59 and K52B on the wire-harness side.
- 3- Using "Intake manifold temperature sensor characteristics", make sure that the measured resistance value is within the normal range.

NG	<ul style="list-style-type: none"> • The coupler between the sensor and the wire-harness may be defective. Replace the sensor. • Replace the wire-harness. Switch the ECU power from OFF to ON for failure diagnosis using SA-D after replacement.
OK	Go to "Checking the intake manifold temperature sensor output voltage".

5. Checking the intake manifold temperature sensor output voltage

- 1- Connect the checker harness between the ECU and engine wire-harness. Also connect all connectors (sensor, ECU).
- 2- Using a circuit tester, measure the voltage between intake manifold temperature sensor signals A59 and K52B.

Voltage	State	Corrective action
$A59 < 0.2 \text{ V}$	NG	<ul style="list-style-type: none"> • Replace the wire-harness. • Replace the ECU.
$0.2 \text{ V} \leq A59 \leq 4.8 \text{ V}$	OK (normal range)	Perform failure diagnosis using SA-D.
$4.8 \text{ V} < A59$	NG	<ul style="list-style-type: none"> • Replace the wire-harness. • Replace the ECU.

NG	<ul style="list-style-type: none"> • The coupler between the wire-harness and the ECU may be defective. Replace the wire-harness. • Replace the ECU. Switch the ECU power from OFF to ON for failure diagnosis using SA-D after replacement.
OK	Switch the ECU power from OFF to ON for failure diagnosis using SA-D.

6. Operation using SA-D

- 1- Turn off the key switch and turn on the key switch again to start the engine. Operate the engine that satisfies the reset criteria for P1676: Intake manifold temperature sensor error (detected value error) (P127).
- 2- Connect the SA-D and check the current fault indication to see whether an error is detected.

No	Normal
Yes	Replace the intake manifold temperature sensor or ECU.

Exhaust manifold temperature sensor

Related DTC

P code	SPN/FMI	Name
P0546	173/3	Exhaust manifold temperature sensor error (voltage high)
P0545	173/4	Exhaust manifold temperature sensor error (voltage low)

Workflow

Note: See "Work description" for work details. Go to "SA-D Operation Manual" for the SA-D operation.

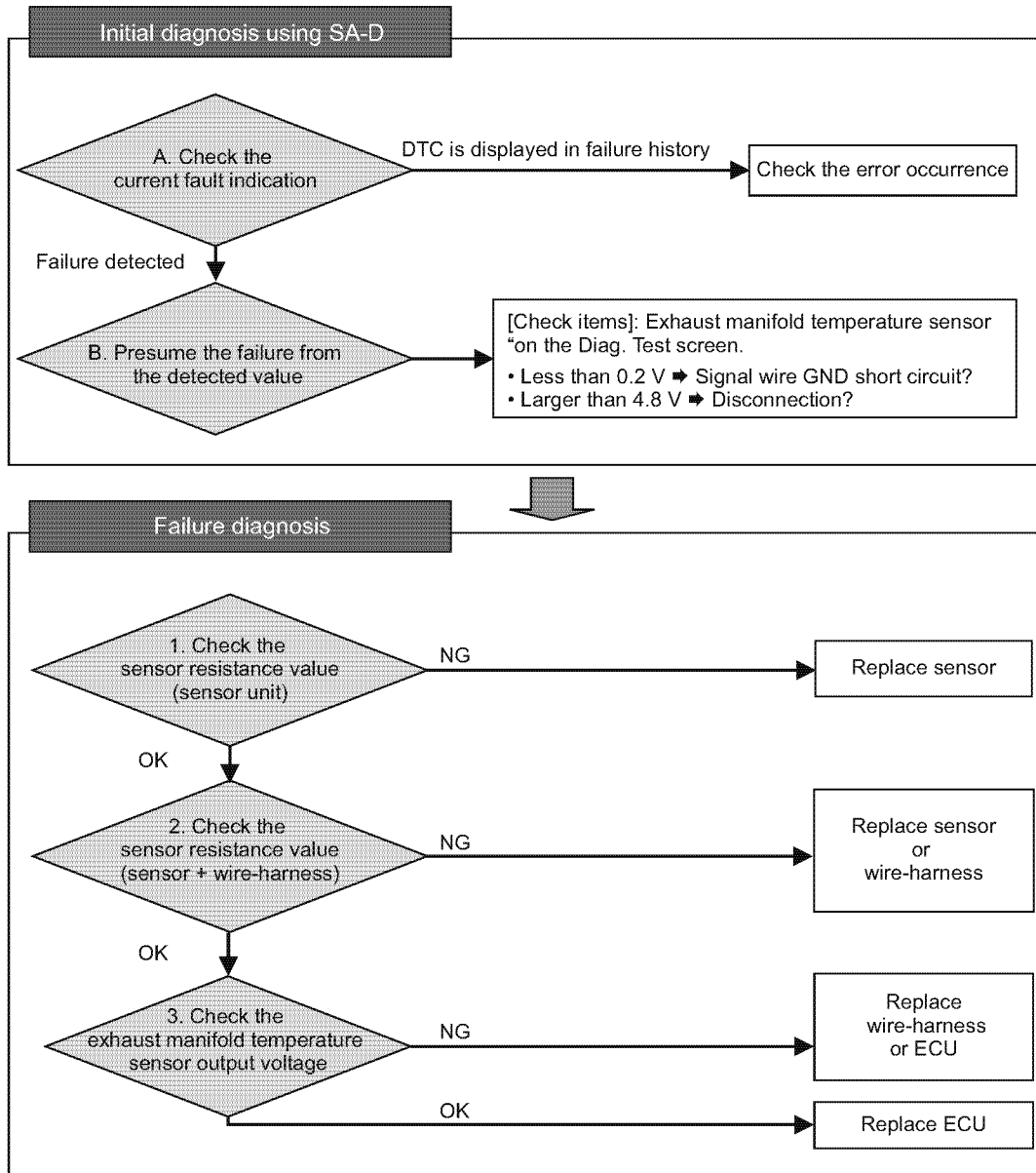

044390-01ENG2

● Wire diagram

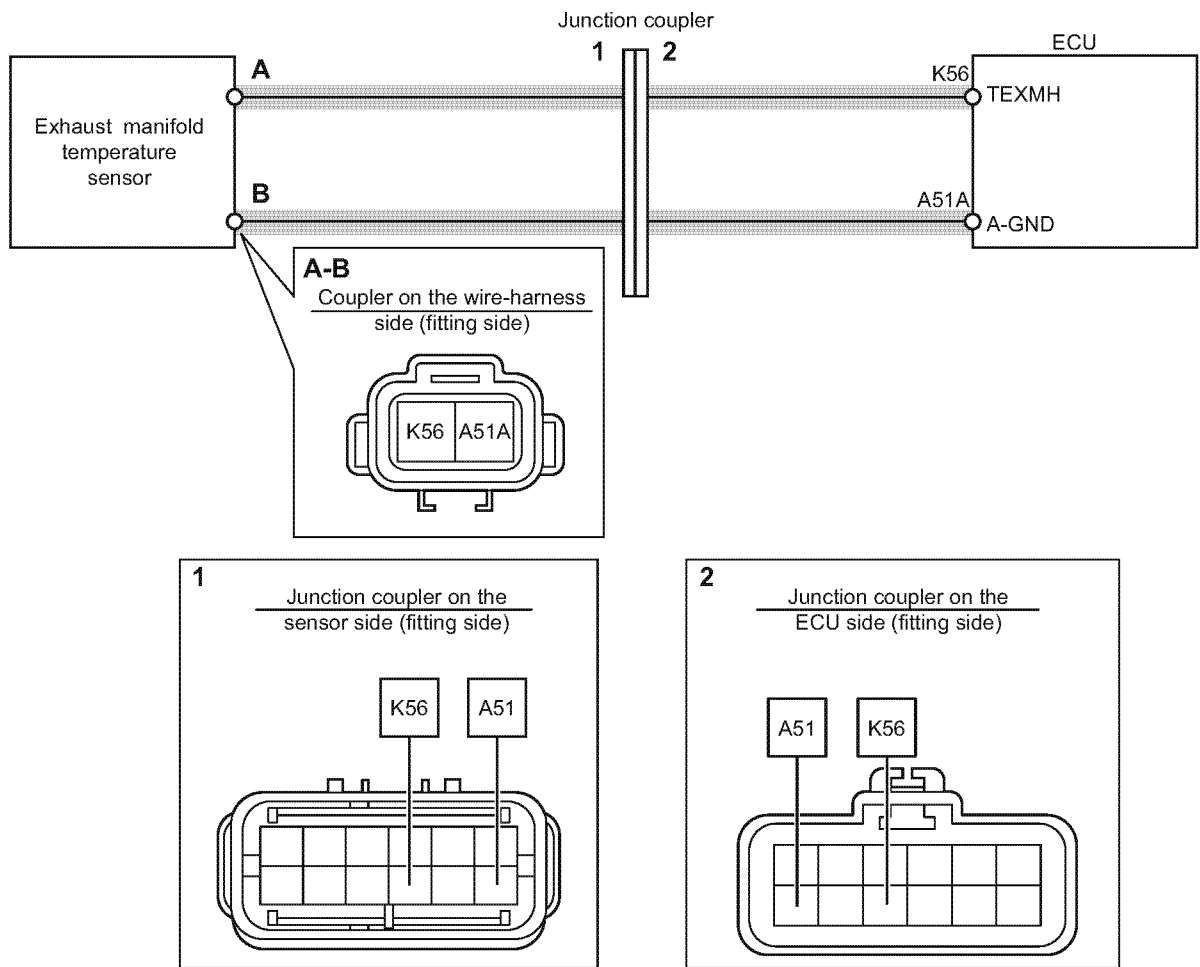

 : Check points

044381-00E100

Note: See P325 for the ECU pin layout.

● **Work description**

1. Checking the sensor resistance value (sensor unit)

- 1- Remove the wire-harness from the exhaust manifold temperature sensor.
- 2- Using a circuit tester, measure the resistance value between exhaust manifold temperature sensor terminals A and B.
- 3- Using “Exhaust manifold temperature sensor characteristics”, make sure that the measured resistance value is within the normal range.

Exhaust manifold temperature sensor characteristics

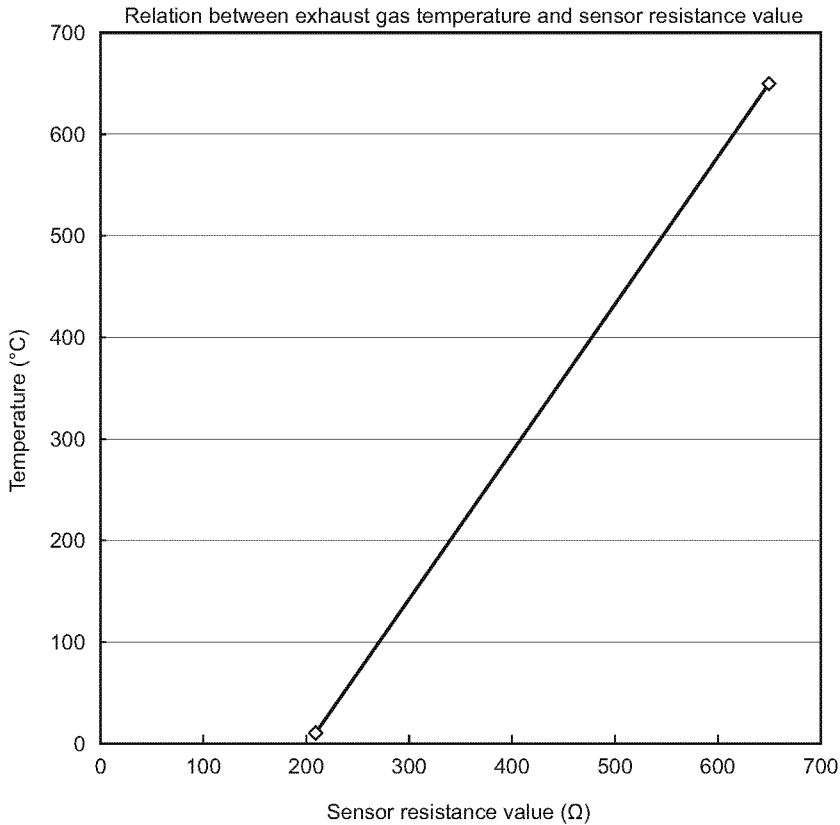

Temperature (°C)	Sensor resistance value (Ω)
10	209.15
650	649.77

044404-00EN00

NG	Replace the exhaust manifold temperature sensor.
OK	Go to “Checking the sensor resistance value (sensor and wire-harness)”.

2. Checking the sensor resistance value (sensor and wire-harness)

- 1- Connect the exhaust manifold temperature sensor and wire-harness, and then remove the ECU from the wire-harness.
- 2- Using a circuit tester, measure the resistance value between the ECU side wire harness connector terminals K56 and A51A.
- 3- Using "Exhaust manifold temperature sensor characteristics", make sure that the measured resistance value is within the normal range.

NG	<ul style="list-style-type: none"> • The coupler between the sensor and the wire-harness may be defective. Replace the sensor. • Replace the wire-harness.
OK	Go to "Checking the exhaust manifold temperature sensor output voltage".

3. Checking the exhaust manifold temperature sensor output voltage

- 1- Connect the checker harness between the ECU and engine wire-harness. Also connect all connectors (sensor, ECU).
- 2- Using a circuit tester, measure the voltage between exhaust manifold temperature sensor signals A56 and A51A.

Voltage	State	Corrective action
K56 < 0.2 V	NG	<ul style="list-style-type: none"> • Replace the wire-harness. • Replace the ECU.
0.2 V ≤ K56 ≤ 4.8 V	OK (normal range)	Replace the ECU.
4.8 V < K56	NG	<ul style="list-style-type: none"> • Replace the wire-harness. • Replace the ECU.

NG	<ul style="list-style-type: none"> • The coupler between the wire-harness and the ECU may be defective. Replace the wire-harness. • Replace the ECU.
OK	Replace the ECU.

● Related DTC

P code	SPN/FMI	Name
P1677	173/10	Exhaust manifold temperature sensor error (detected value error)

● Workflow

Note: See "Work description" for work details. Go to "SA-D Operation Manual" for the SA-D operation.

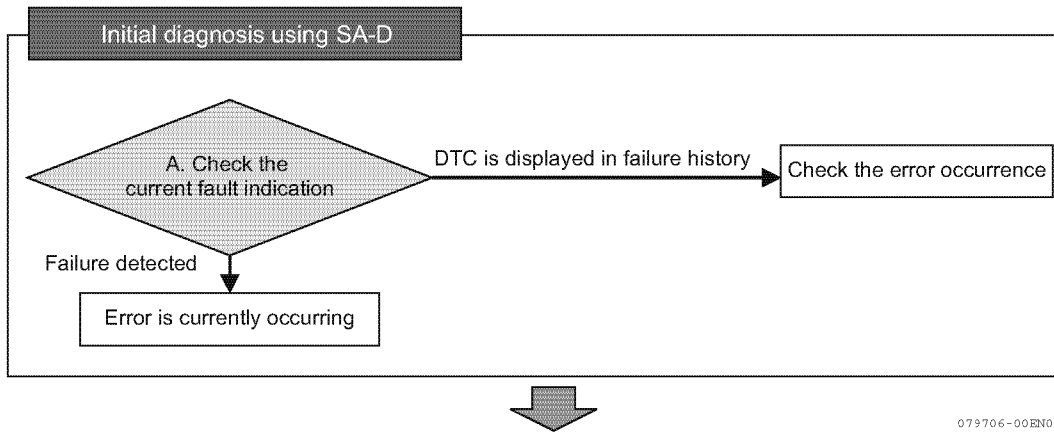

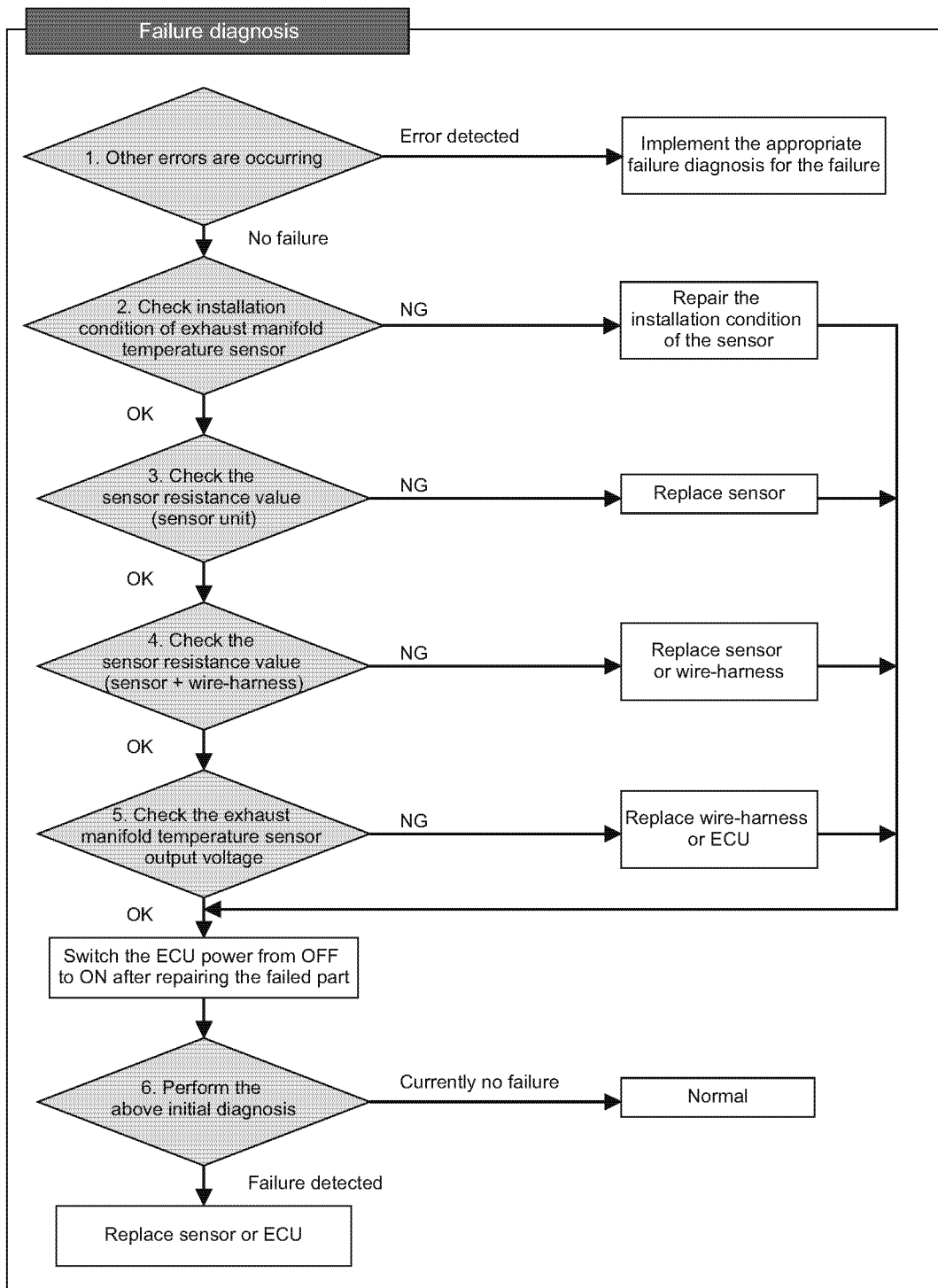

079723-00EN04

● Wire diagram

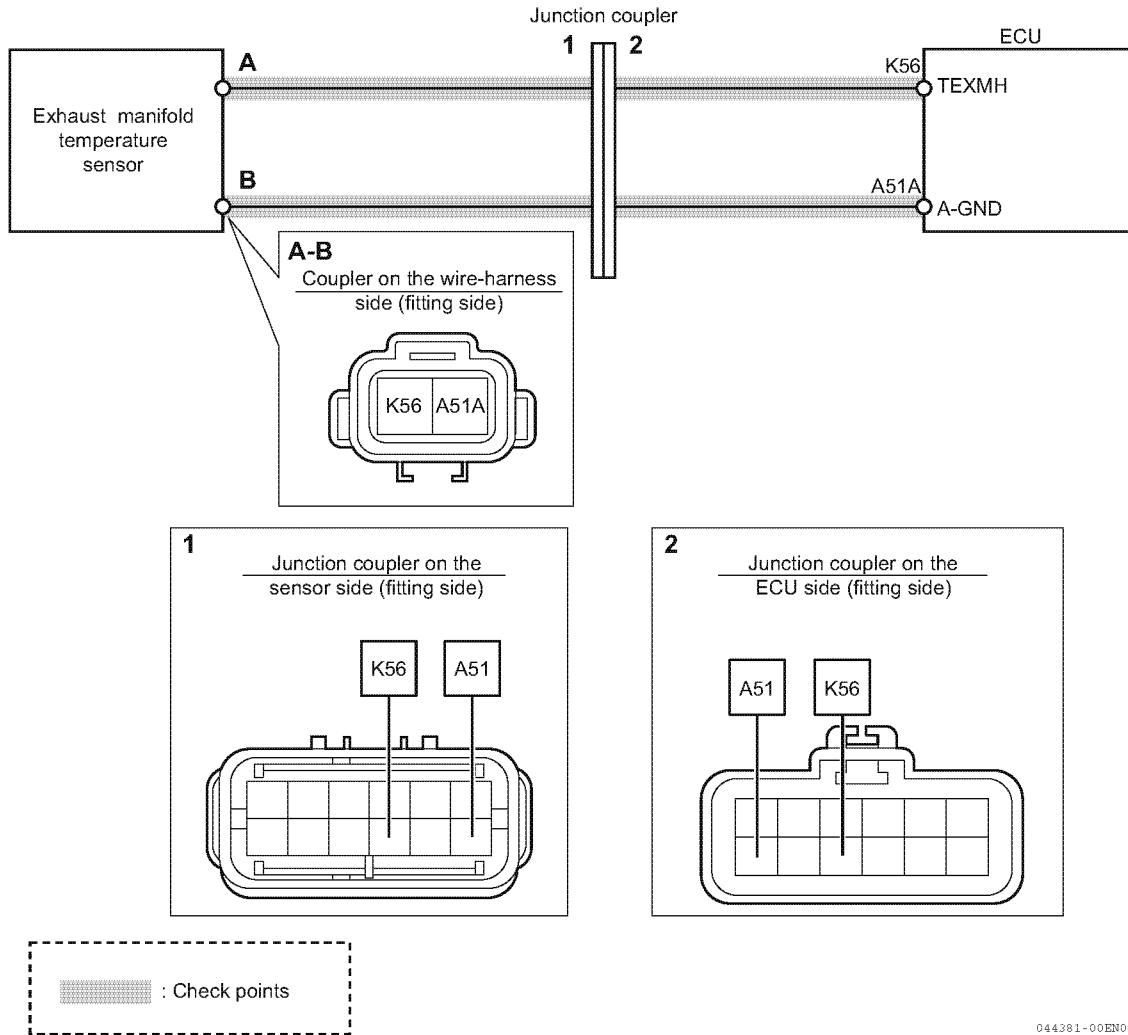

044381-00EN00

Note: See P325 for the ECU pin layout.

● Work description

1. Checking for other errors

- 1- Turn off the key switch and turn on the key switch again.
- 2- Connect the SA-D and check the current fault indication to see whether any other errors are detected. Particularly, check to see whether any errors are detected for exhaust manifold temperature sensor, engine coolant temperature sensor, DPF inlet temperature sensor, or inside the ECU.

Error detected	Implement the appropriate failure diagnosis for the failure.
No error detected	Go to "Checking installation condition of exhaust manifold temperature sensor".

2. Checking installation condition of exhaust manifold temperature sensor

- 1- Turn off the key switch.
- 2- Check the installation condition of exhaust manifold temperature sensor.
- 3- Make sure that there is nothing wrong (disconnections and damages) with the exhaust piping, pressure hose, or pressure pipe.

NG	Reinstall the sensor, and turn off/on the ECU power for failure diagnosis using SA-D.
OK	Go to "Checking the sensor resistance value (sensor unit)"

3. Checking the sensor resistance value (sensor unit)

- 1- Remove the wire-harness from the exhaust manifold temperature sensor.
- 2- Using a circuit tester, measure the resistance value between exhaust manifold temperature sensor terminals A and B.
- 3- Using "Exhaust manifold temperature sensor characteristics", make sure that the measured resistance value is within the normal range.

Exhaust manifold temperature sensor characteristics

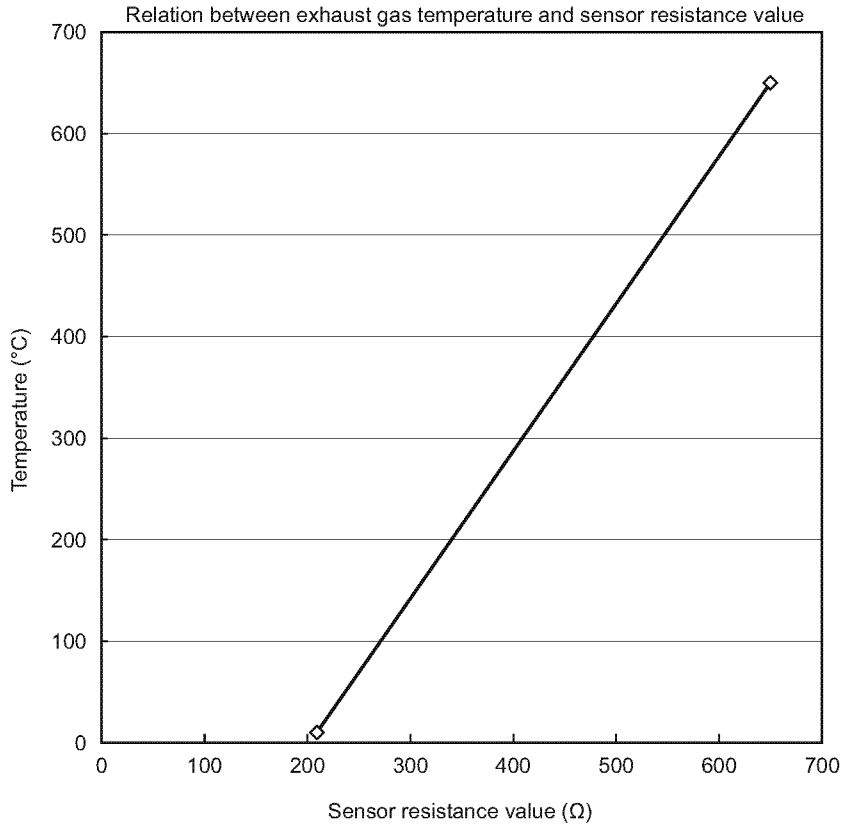

Temperature (°C)	Sensor resistance value (Ω)
10	209.15
650	649.77

044404-00EN00

NG	Replace the exhaust manifold temperature sensor, and switch the ECU power from OFF to ON for failure diagnosis using SA-D.
OK	Go to "Checking the sensor resistance value (sensor and wire-harness)".

4. Checking the sensor resistance value (sensor and wire-harness)

- 1-Connect the exhaust manifold temperature sensor and wire-harness, and then remove the ECU from the wire-harness.
- 2-Using a circuit tester, measure the resistance value between ECU connector terminals K56 and A51A on the wire-harness side.
- 3-Using "Exhaust manifold temperature sensor characteristics", make sure that the measured resistance value is within the normal range.

NG	<ul style="list-style-type: none"> • The coupler between the sensor and the wire-harness may be defective. Replace the sensor. • Replace the wire-harness. Switch the ECU power from OFF to ON for failure diagnosis using SA-D after replacement.
OK	Go to "Checking the exhaust manifold temperature sensor output voltage".

5. Checking the exhaust manifold temperature sensor output voltage

- 1-Connect the checker harness between the ECU and engine wire-harness. Also connect all connectors (sensor, ECU).
- 2-Using a circuit tester, measure the voltage between exhaust manifold temperature sensor signals K56 and A51A.

Voltage	State	Corrective action
$K56 < 0.2 \text{ V}$	NG	<ul style="list-style-type: none"> • Replace the wire-harness. • Replace the ECU.
$0.2 \text{ V} \leq K56 \leq 4.8 \text{ V}$	OK (normal range)	Perform failure diagnosis using SA-D.
$4.8 \text{ V} < K56$	NG	<ul style="list-style-type: none"> • Replace the wire-harness. • Replace the ECU.

NG	<ul style="list-style-type: none"> • The coupler between the wire-harness and the ECU may be defective. Replace the wire-harness. • Replace the ECU. Switch the ECU power from OFF to ON for failure diagnosis using SA-D after replacement.
OK	Switch the ECU power from OFF to ON for failure diagnosis using SA-D.

6. Operation using SA-D

- 1-Turn off the key switch and turn on the key switch again to start the engine. Operate the engine that satisfies the reset criteria for P1677: Exhaust manifold temperature sensor error (detected value error) (P133).
- 2-Connect the SA-D and check the current fault indication to see whether an error is detected.

No	Normal
Yes	Replace the exhaust manifold temperature sensor or ECU.

Contact output related

■ Main relay

● Related DTC

P code	SPN/FMI	Name
P068B	1485/7	Main relay contact sticking
P068A	1485/2	Main relay early opening

● Workflow

Note: See "Work description" for work details. Go to "SA-D Operation Manual" for the SA-D operation.

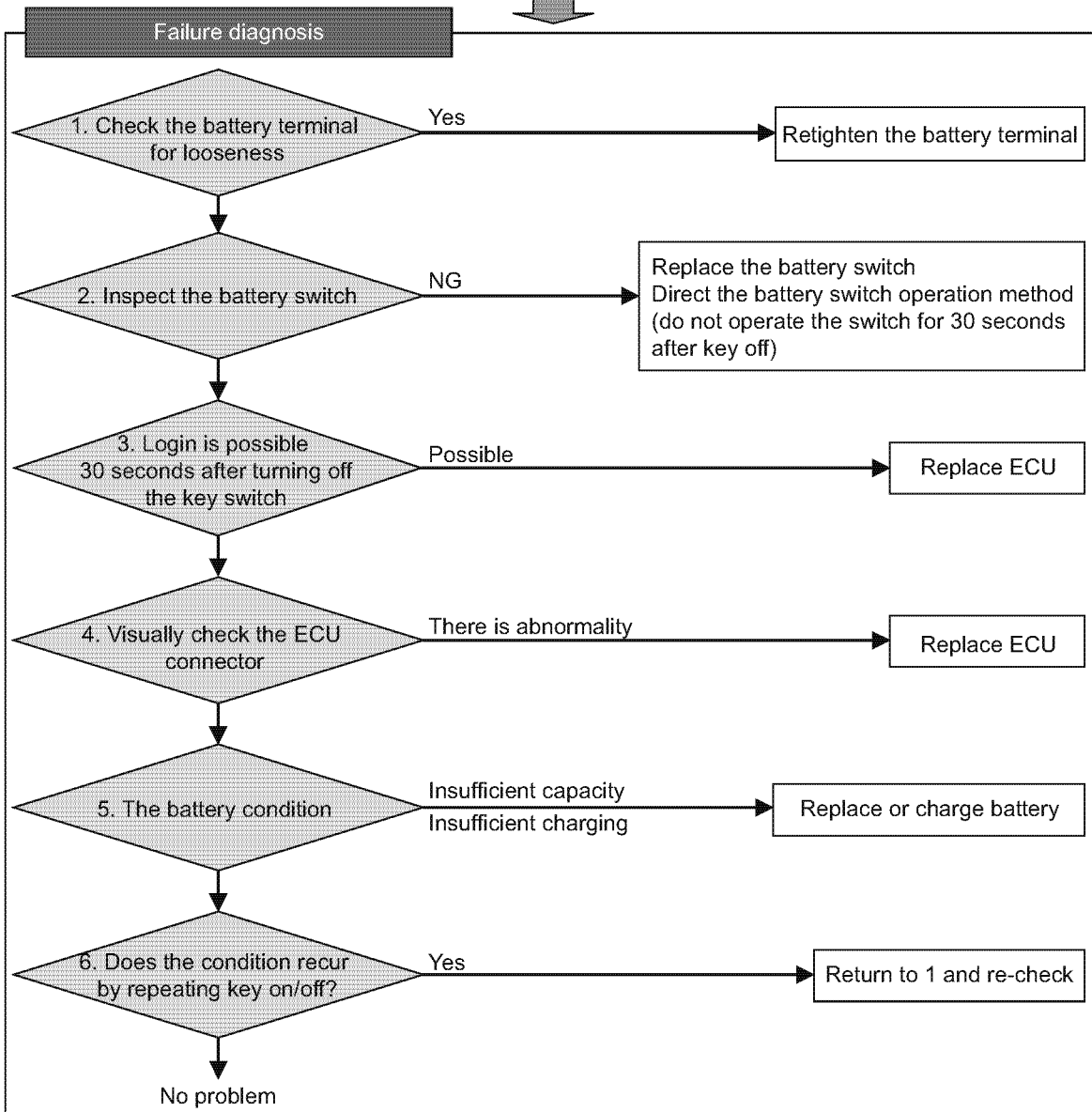
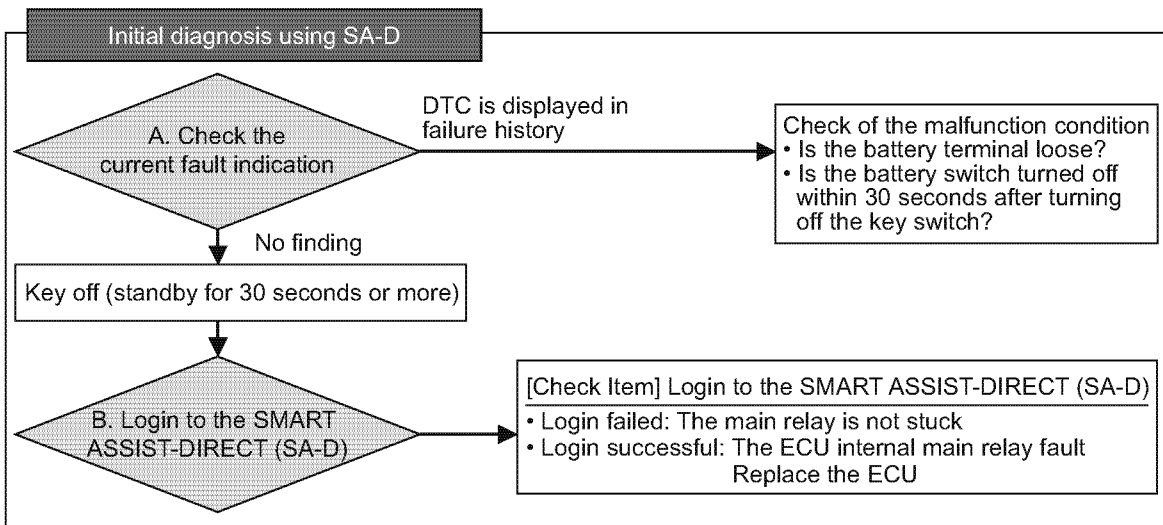

050498-00EN03

● Wire diagram

Note: The main relay is equipped with an ECU.

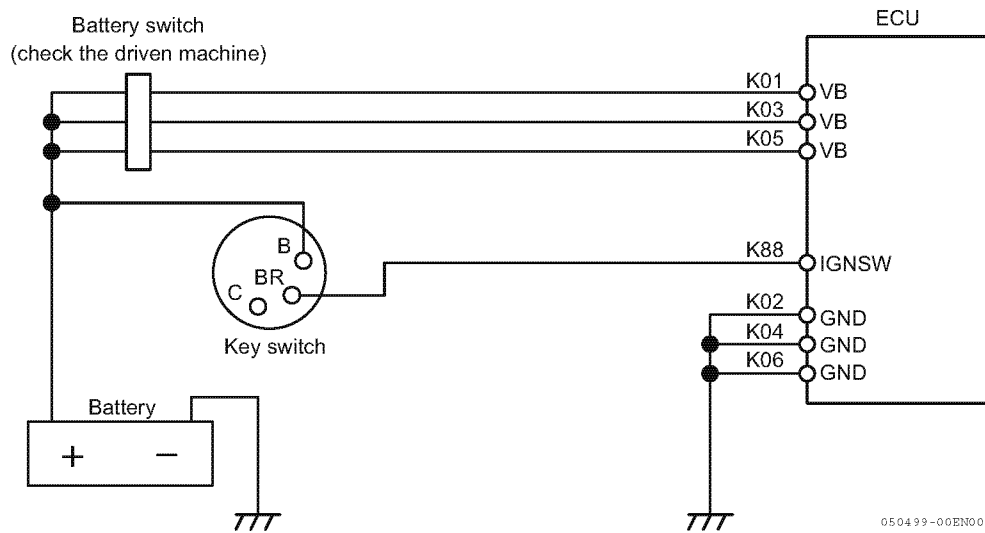

Note: See P325 for the ECU pin layout.

● Work description

1. Check the battery terminal for looseness

- Check whether or not the wiring from the battery to the ECU VB terminal is loose or damaged.
- Check whether or not the joints to the battery GND terminal and the frame are loose.
- Check whether or not the wiring from the ECU GND terminal to the frame GND is loose or damaged.
- Check whether or not the wiring from the ECU IGN terminal to the key switch is loose or damaged.

2. Inspect the battery switch

Depending on the driven machine, there is a battery switch for the purpose of long-term storage besides the key switch. For details, contact the driven machine manufacturer.

- Check the wiring of the battery switch for looseness.
- Check the battery switch for abnormality.
- Do not perform the cutoff operation of the battery switch within 30 seconds after the key off. Direct the operation method to the operator.

3. Login check to the SMARTASSIST-DIRECT (SA-D)

When 30 seconds or more are elapsed after turning off the key switch, the ECU operation stops completely. Connect the SMARTASSIST-DIRECT (SA-D) after the elapse of 30 seconds or more after the key off and check whether or not you can login. If you can login after the elapse of 30 seconds or more, there is a possibility that the ECU internal main relay is faulty. Replace the ECU.

4. Visually check the ECU connector

Visually check the VB pins (K01, K03, K05) and the GND pins (K02, K04, K06) of the ECU connector. If there is broken or bent pin, replace the ECU.

5. The battery condition

The insufficient battery charging or the battery capacity reduction may lead to the supply voltage reduction, resulting in the early opening abnormality of the main relay. Inspect the battery.

6. Check the recurrence

Repeat turning on/off the key switch for a few times and check that the concerned abnormality does not recur. If the abnormality recurs, perform the inspection again from Step 1. If the abnormality does not recur, there is no problem with the main relay.

■ Starting aid relay (Glow relay)

● Related DTC

P code	SPN/FMI	Name
P0543	522243/5	Starting aid relay disconnection
P0541	522243/6	Starting aid relay GND short circuit

● Workflow

Note: See "Work description" for work details. Go to "SA-D Operation Manual" for the SA-D operation.

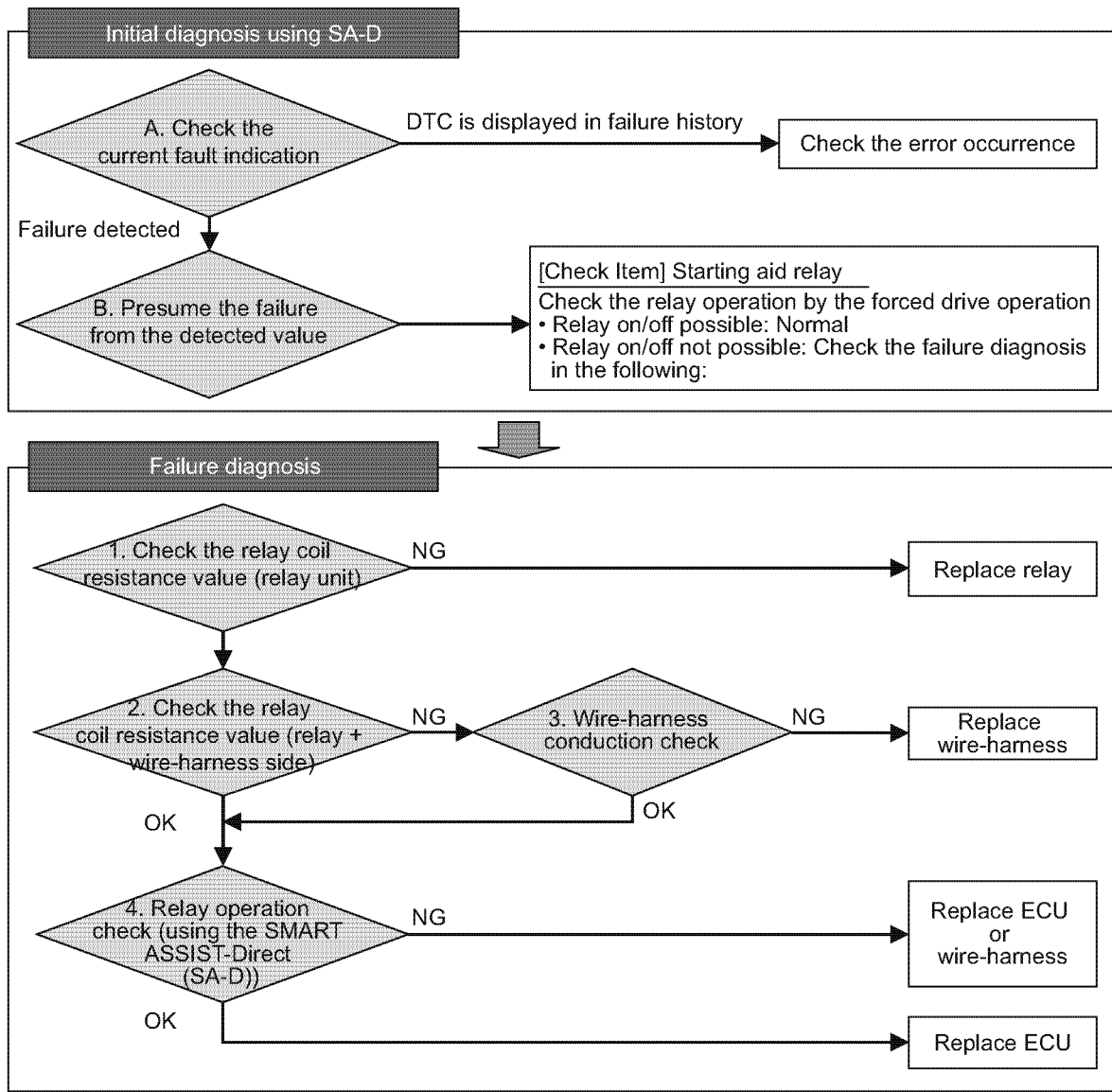

050500-00EN01

● Wire diagram

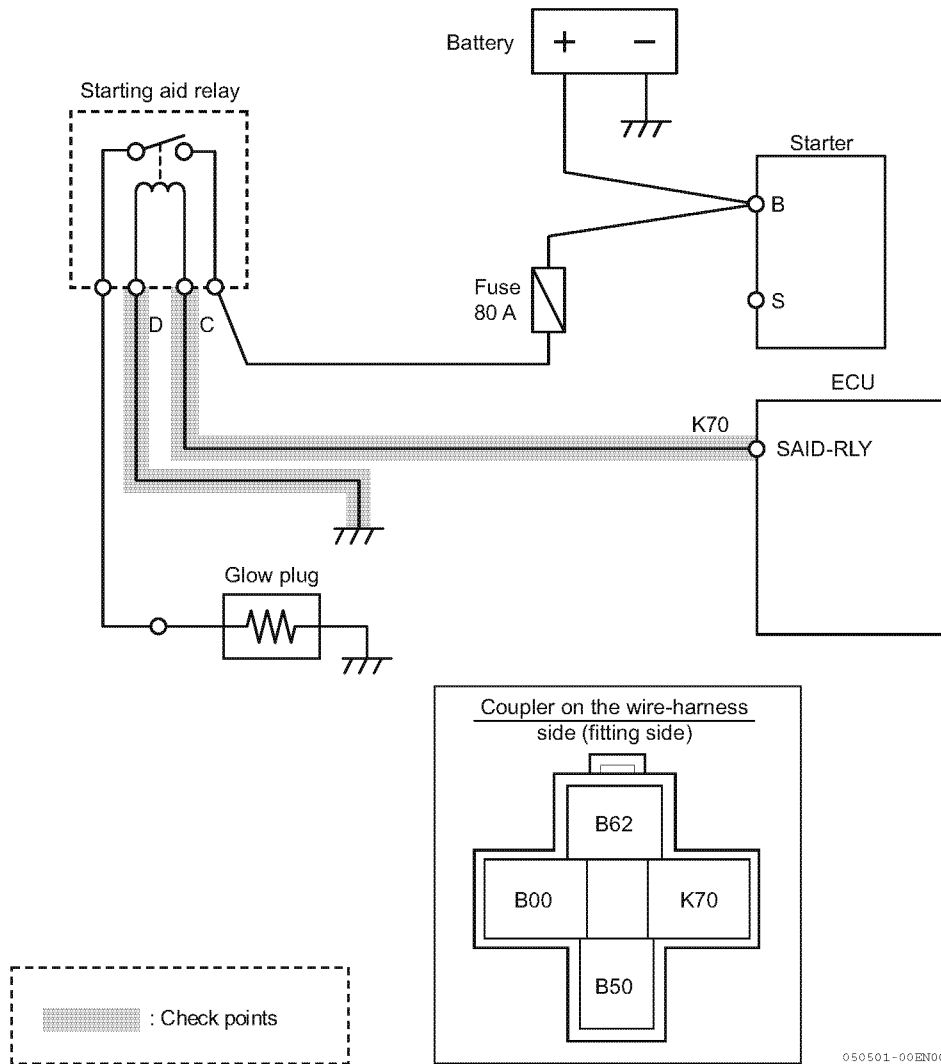

Note: See P325 for the ECU pin layout.

● **Work description**

1. Checking the relay coil resistance value (relay unit)

- 1- Remove the wire-harness from the starting aid relay.
- 2- Using a circuit tester, measure the resistance value between the relay side terminals C and D.

Resistance value of YANMAR standard starting aid relay

Relay	Terminal	Specifications
129927-77930 (40 A)	Relay coil side C - D	103 Ω ± 10% (at 20 °C)
129927-77920 (70 A)	Relay coil side C - D	103 Ω ± 10% (at 20 °C)
129927-77900 (90 A)	Relay coil side C - D	80 Ω (at 20 °C)

NG	Replace the starting aid relay.
OK	Check the relay coil resistance value while the starting aid relay and the wire-harness are connected. Go to "Checking the relay coil resistance value (relay + wire-harness side)".

2. Checking the relay coil resistance value (relay + wire-harness side)

- 1- Connect the starting aid relay to the wire-harness. Remove the ECU from the wire-harness.
- 2- Using a circuit tester, measure the resistance value between the ECU connectors K70 and K02.

Note: See the above "Resistance value of YANMAR standard starting aid relay".

NG	Check the wire-harness conduction. Go to "Wire-harness conduction check".
OK	Use the SMARTASSIST-DIRECT (SA-D) to check the operation of the starting aid relay. Go to "Relay operation check".

3. Wire-harness conduction check

- 1- Remove the wire-harness from the starting aid relay and the ECU.
- 2- Using a circuit tester, measure the wire-harness conduction.

Terminal	Conduction	State
Relay coil E70 side (between ECU and relay connector)	Yes	OK: Normal
	No	NG: Wire-harness open circuit
Relay coil E00 side (between ECU and relay connector)	Yes	OK: Normal
	No	NG: Wire-harness open circuit
Between K70 - GND/K02/K04/K06	No	OK: Normal
	Yes	NG: Wire-harness open circuit
Between E70 - VB/K01/K03/K05	No	OK: Normal
	Yes	NG: Wire-harness open circuit

NG	<ul style="list-style-type: none"> • Check the wire-harness for damage. Check the wiring for mis-connection. • Replace the wire-harness.
OK	Use the SMARTASSIST-DIRECT (SA-D) to check the operation of the starting aid relay. Go to "Relay operation check".

4. Relay operation check

1-Connect the checker harness between the ECU and the machine wire-harness (For details, refer to “How to use the Tier 4 checker harness” on page 327). Also, connect all connectors (starting aid relay, ECU).

2-Turn on the key switch. Login to the SMARTASSIST-DIRECT (SA-D).

3-Operate the starting aid relay on the “Diagnosis Test: Forced Drive” of the SMARTASSIST-DIRECT (SA-D).

At this time, measure the voltage between the terminals K70 and K02.

ON/OFF setting condition	Voltage	State
ON	2.5 V or more	OK: Normal
	Less than 2.5 V	NG: Wire-harness GND short circuit or ECU failure
OFF	1.75 V or below	OK: Normal
	Over 1.75 V	NG: Wire-harness power short circuit or ECU failure

NG	<ul style="list-style-type: none"> • Check the wire-harness for damage. Check the wiring for mis-connection. • Replace the wire-harness.
OK	Replace the ECU.

■ Breather heater (Optional parts for 4TNV86CT and 4TNV98CT)

● Related DTC

P code	SPN/FMI	Name
P053A	3059/5	Breather heater disconnection
P053B	3059/4	Breather heater short circuit (GND)
P053C	3059/3	Breather heater short circuit (VB)

● Workflow

Note: See "Work description" for work details. Go to "SA-D Operation Manual" for the SA-D operation.

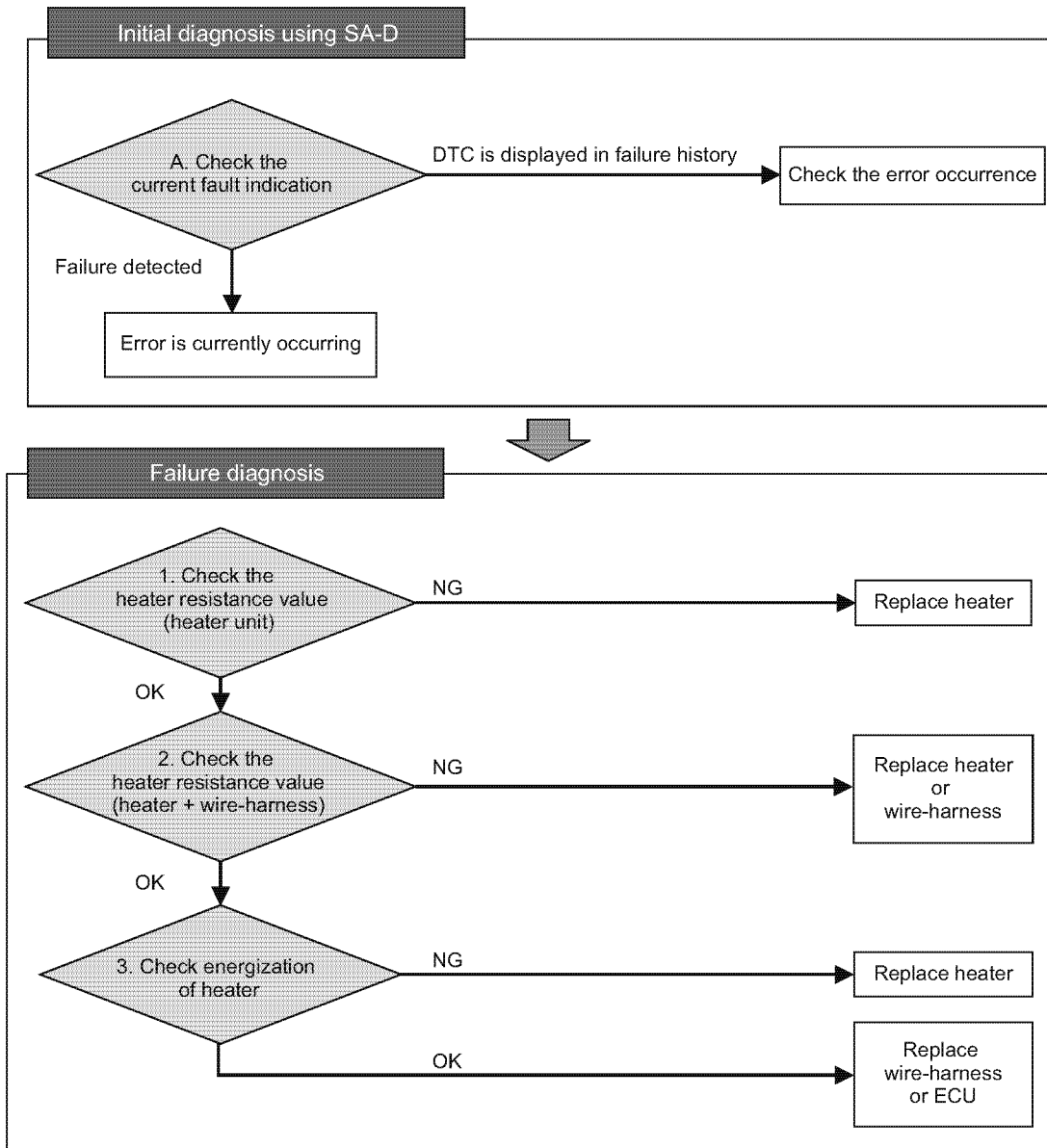

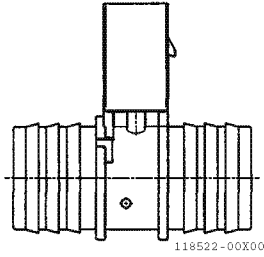

118521-00EN00

● Heater diagram

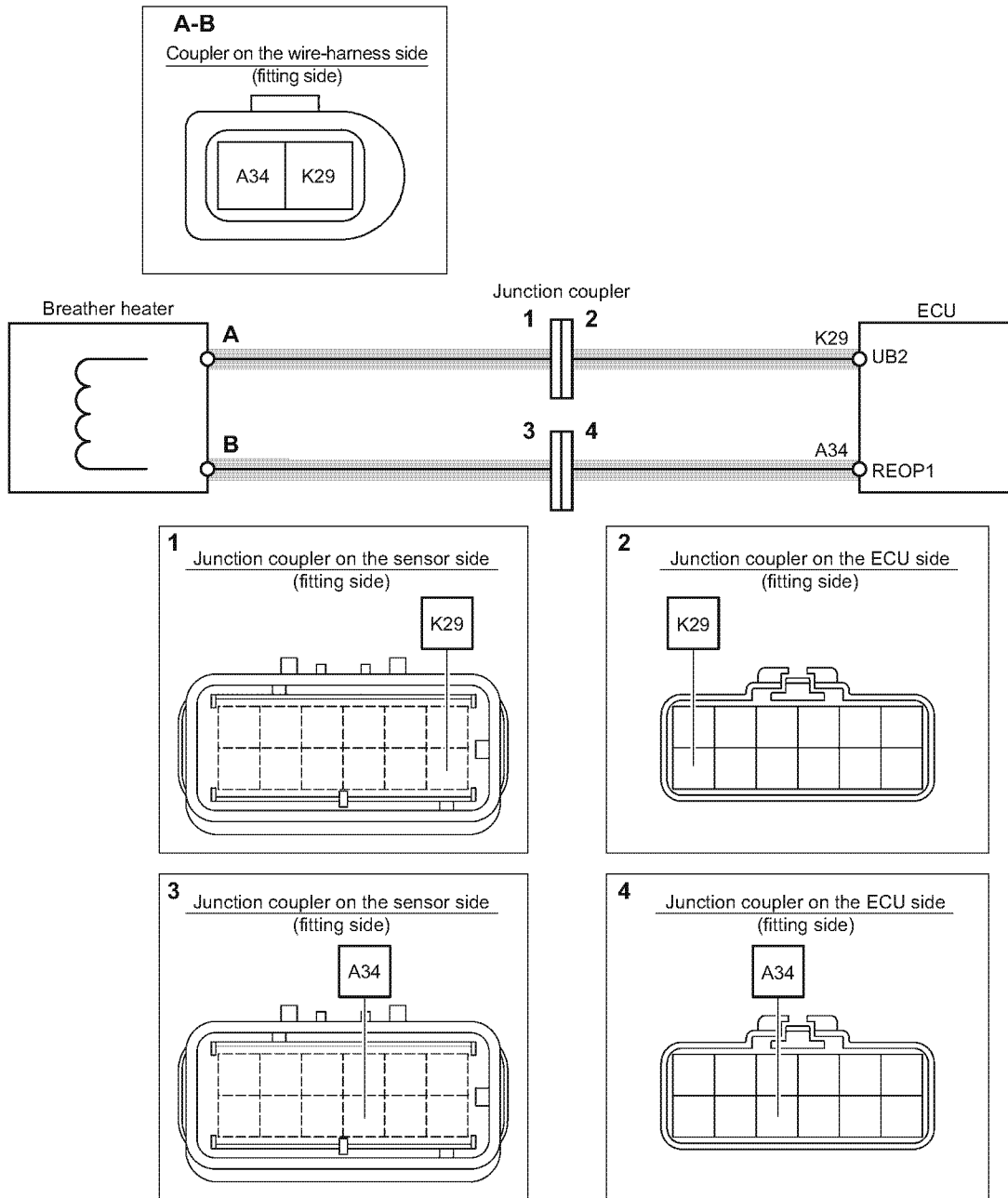

● Wire diagram



 : Check points

118522-00E000

Note: See P325 for the ECU pin layout.

● **Work description**

1. Checking the resistance values of the breather heater (heater unit)

1- Remove the breather heater from the wire-harness.

2- Using a circuit tester, measure the resistance value between the breather heater terminals A and B.

Reference: Resistance value between breather heater terminals

Terminal	Specification
Heater A to B	Criteria: $10 \pm 5 \Omega$ with the heater temperature between 20 to 40 °C. The heater resistance changes depending on the temperature. (see the figure below)

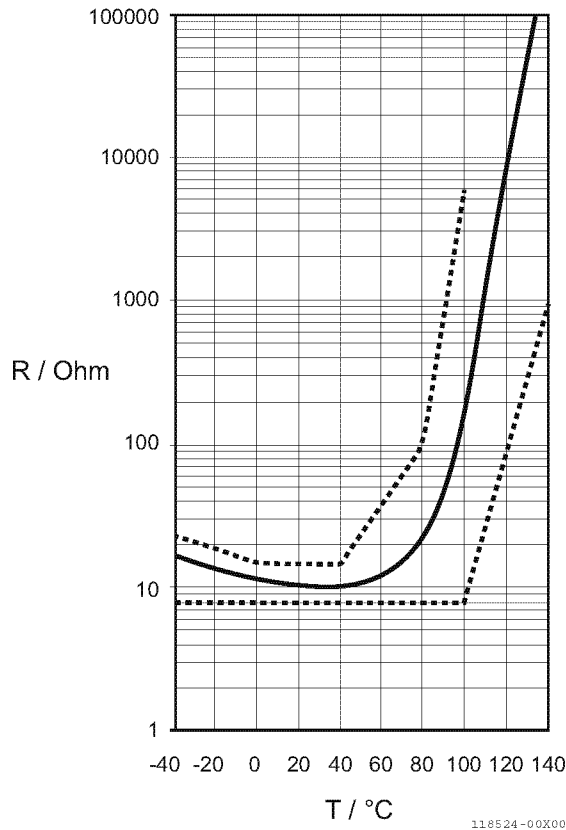

NG	Replace the breather heater.
OK	See "Checking the resistance values of the breather heater (heater and wire-harness)".

2. Checking the resistance values of the breather heater (heater and wire-harness)

1- Remove the ECU from the wire-harness while the breather heater and the wire-harness are connected.

2- Using a circuit tester, measure the resistance value between the ECU connector terminals K29 and A34 on the wire-harness side.

Note: See "Reference: Resistance value between breather heater terminals".

NG	<ul style="list-style-type: none"> • The coupler connecting the heater and wire-harness might have failed. Replace the heater. • Replace the wire-harness.
OK	See "Checking energization of heater".

3. Checking energization of heater

1-Apply 12 V between the breather heater A and B, then measure the current.

Note: See "Reference: Relation between the heater current and temperature".

Reference: Relation between the heater current and temperature

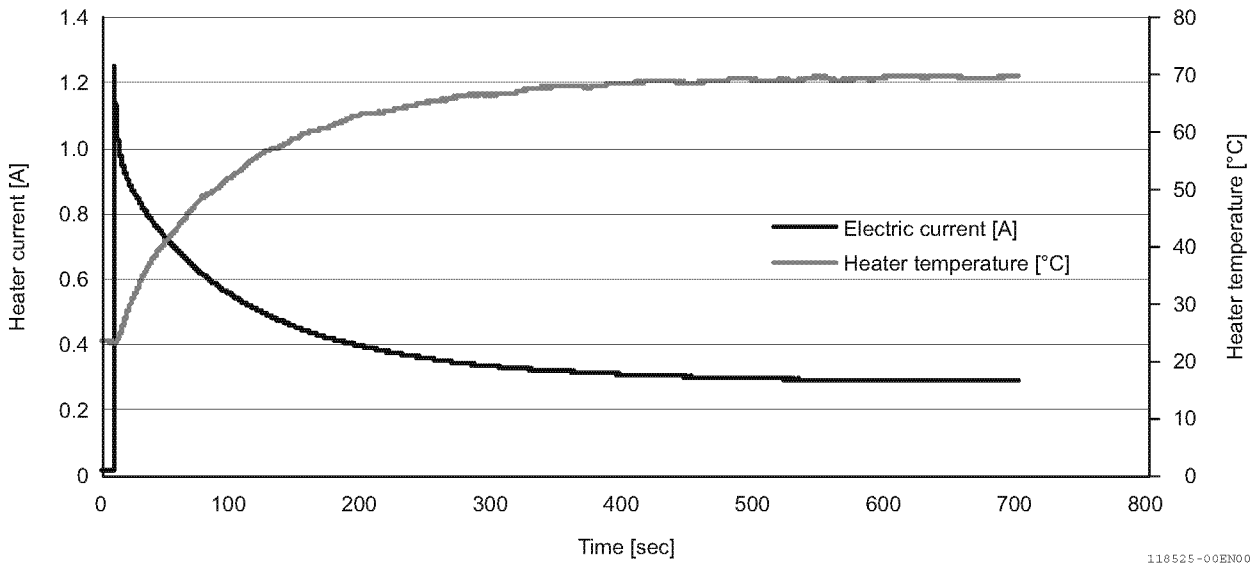

NG	Replace the heater.
OK	<ul style="list-style-type: none"> The coupler connecting the ECU and wire-harness might have failed. Replace the wire-harness. Replace the ECU.

Contact input related

■ Contact input related 1

● Related DTC

P code	SPN/FMI	Name
P1192	100/4	Oil pressure switch open circuit
P1198	100/1	Low oil pressure fault alarm
P1562	167/5	Charge switch open circuit
P1568	167/1	Charge alarm

● Workflow

Note: See "Work description" for work details. Go to "SA-D Operation Manual" for the SA-D operation.

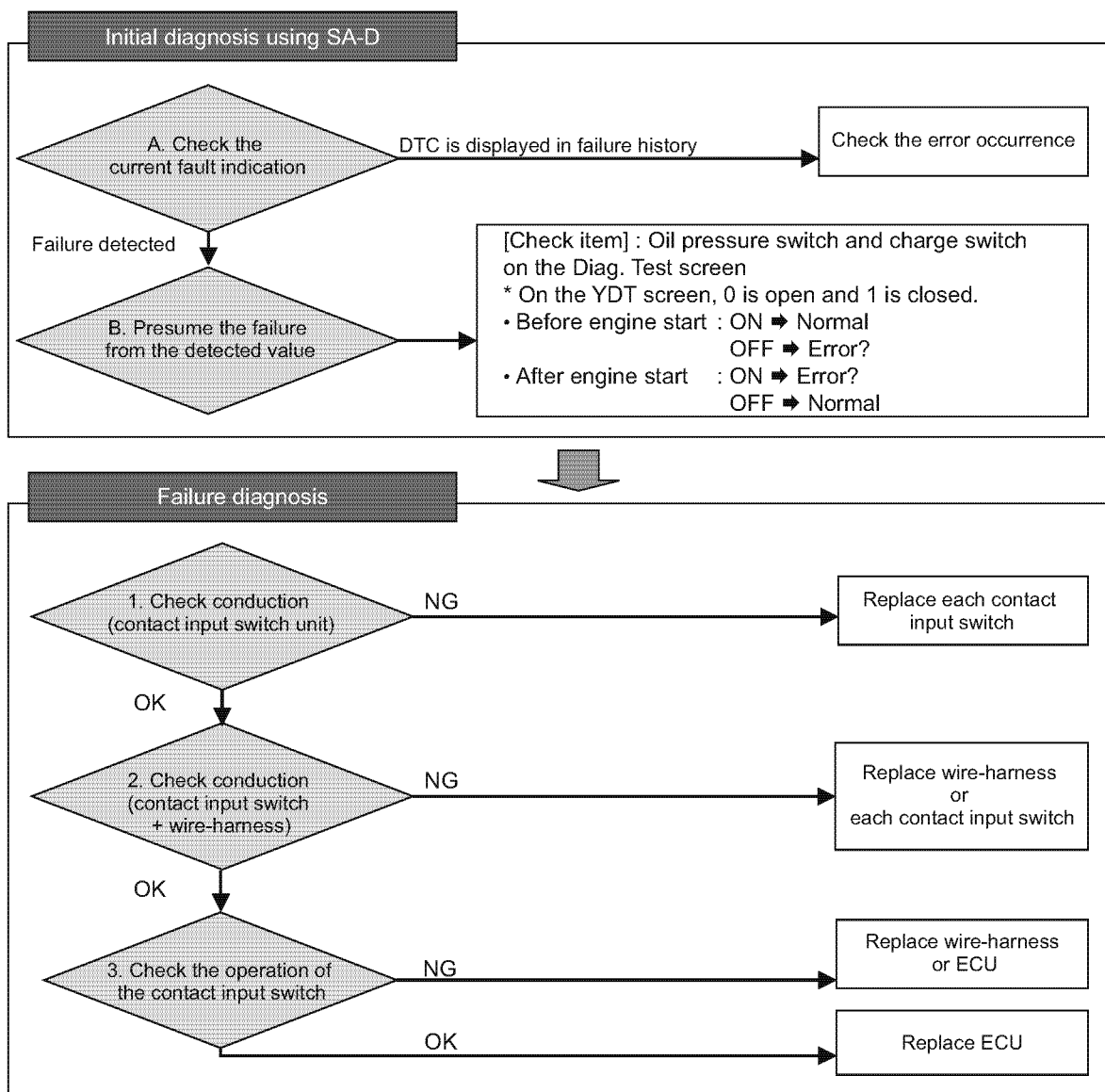

044391-01EN00

● Wire diagram

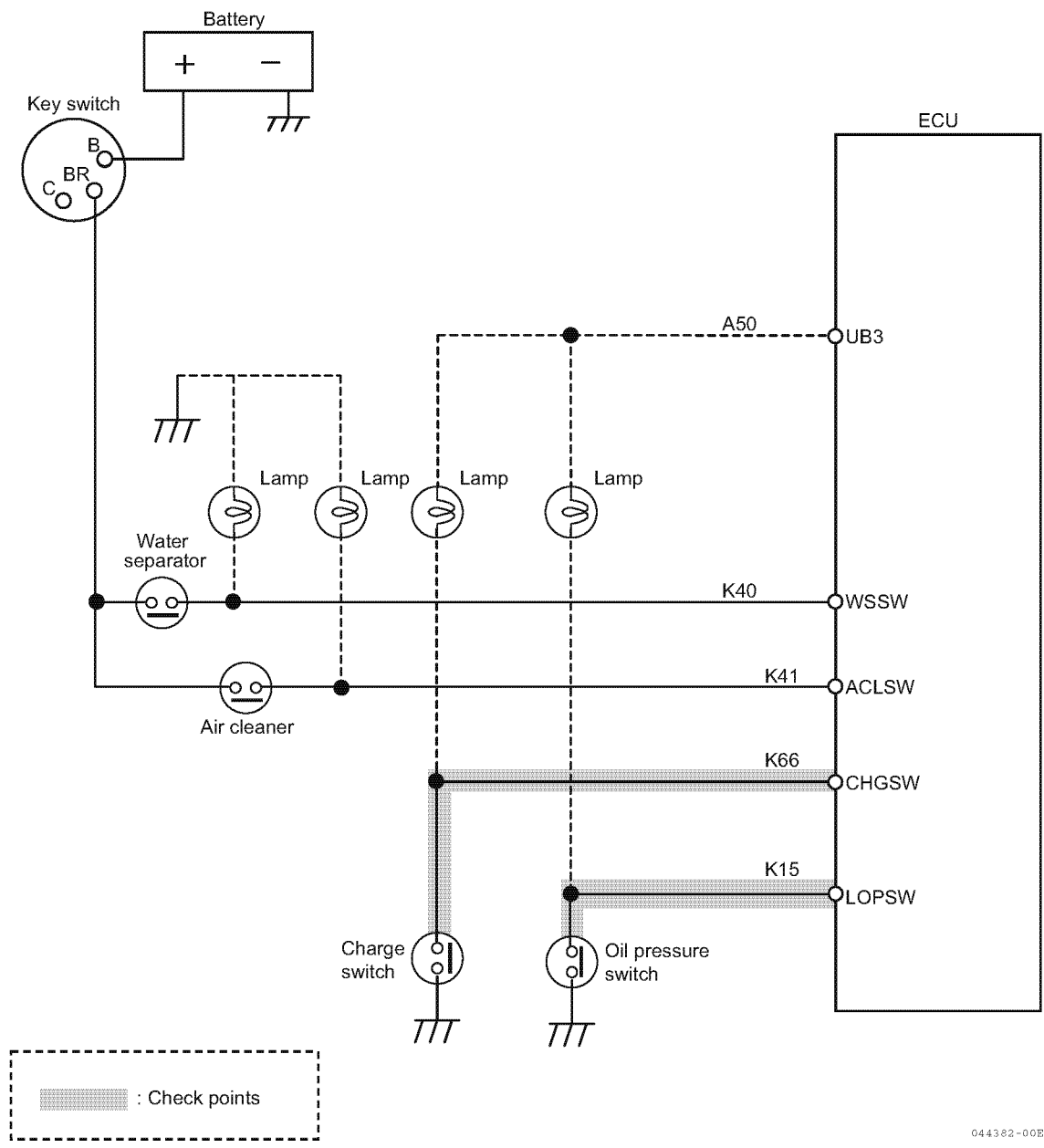

044382-00EN00

Note: See P325 for the ECU pin layout.

● **Work description**

1. Checking the conduction (contact input switch unit)

- 1- Turn off the ECU power.
- 2- Remove the wire-harness from each contact input switch.
- 3- Using a circuit tester, check the conduction between the contact input terminal and the body frame while referring to the following table.

Item	Terminal No.	Conduction (between terminal and body frame)	State
Oil pressure switch	K15	Yes	OK: Normal
		No	NG: Error
Charge switch	K66	No	OK: Normal
		Yes	NG: Error

NG	Replace the contact input switch.
OK	Go to "Checking the conduction (contact input switch and wire-harness)".

2. Checking the conduction (contact input switch and wire-harness)

- 1- Connect the contact input switch to the wire-harness. Remove the ECU from the wire-harness.
- 2- Using a circuit tester, measure the conduction between the ECU connector terminal and the body frame of the wire-harness. For the number of the terminal that is checked, refer to 1. above.

NG	<ul style="list-style-type: none"> • A coupler failure between the contact input switch and the wire-harness may be caused. Replace the contact input switch. • Replace the wire-harness.
OK	Go to "Check the operation of the contact input switch".

3. Check the operation of the contact input switch

- 1- Connect all connectors (contact input switch, ECU, junction coupler).
- 2- Connect SA-D, turn on the key switch, and then log in to SA-D.
- 3- Using SA-D's "Diagnosis Test: Digital input", monitor each indicated item, and check the ON/OFF display of the contact input switch under specific conditions.

Item	Check condition	ON/OFF indication	State
Oil pressure switch	Before engine start	ON (1)	OK: Normal
		OFF (0)	NG: Error
	During engine operation	OFF (0)	OK: Normal
		ON (1)	NG: Error
Charge switch	Before engine start	ON (1)	OK: Normal
		OFF (0)	NG: Error
	During engine operation	OFF (0)	OK: Normal
		ON (1)	NG: Error

NG	<ul style="list-style-type: none"> • The coupler between the wire-harness and the ECU may be defective. Replace the wire-harness. • Replace the ECU.
OK	Replace the ECU.

■ Contact input related 2

● Related DTC

P code	SPN/FMI	Name
P1101	522323/0	Air cleaner clogged alarm
P1151	522329/0	Water separator alarm

● Workflow

Note: See "Work description" for work details. Go to "SA-D Operation Manual" for the SA-D operation.

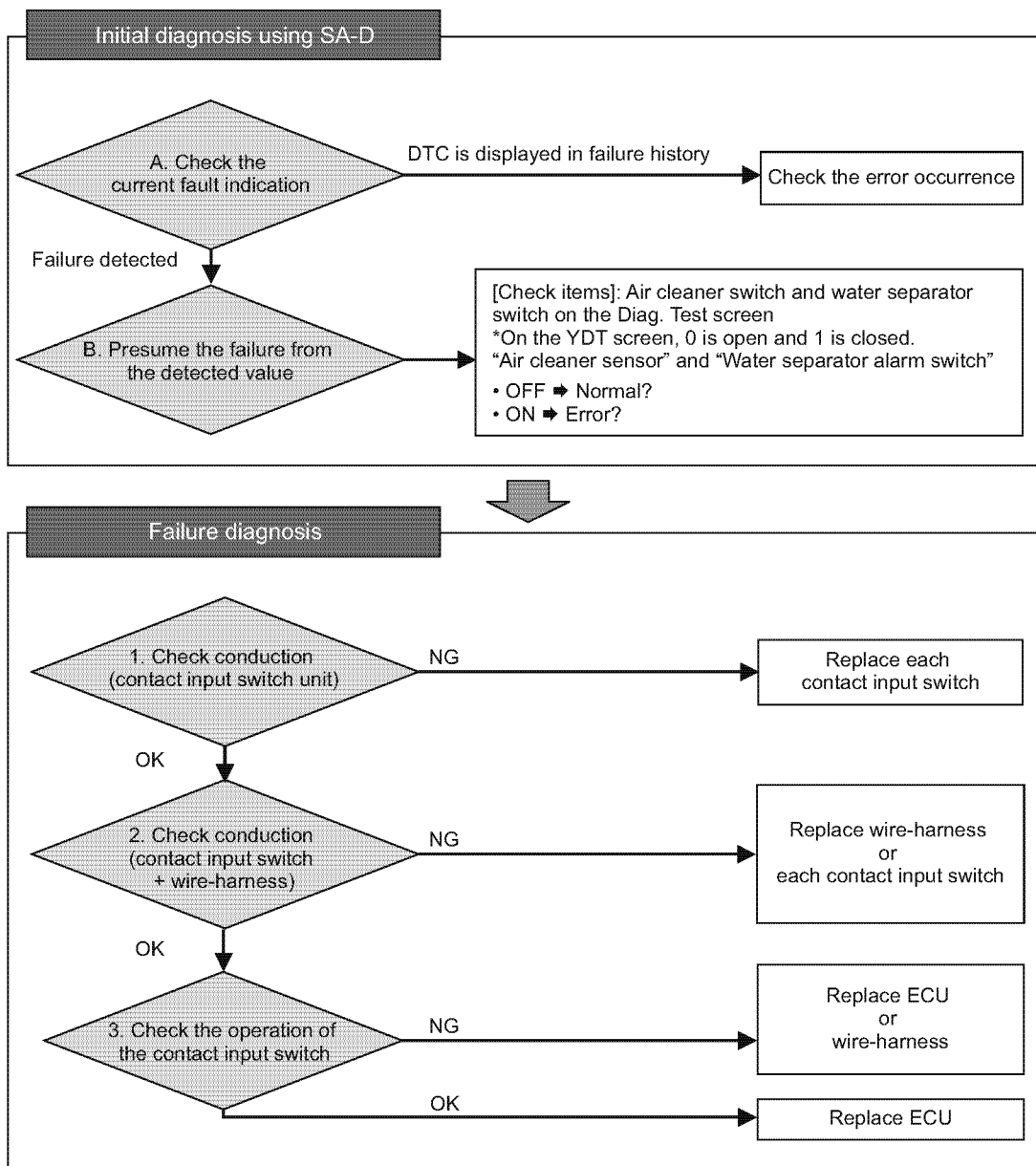

044392-01EN01

● Wire diagram

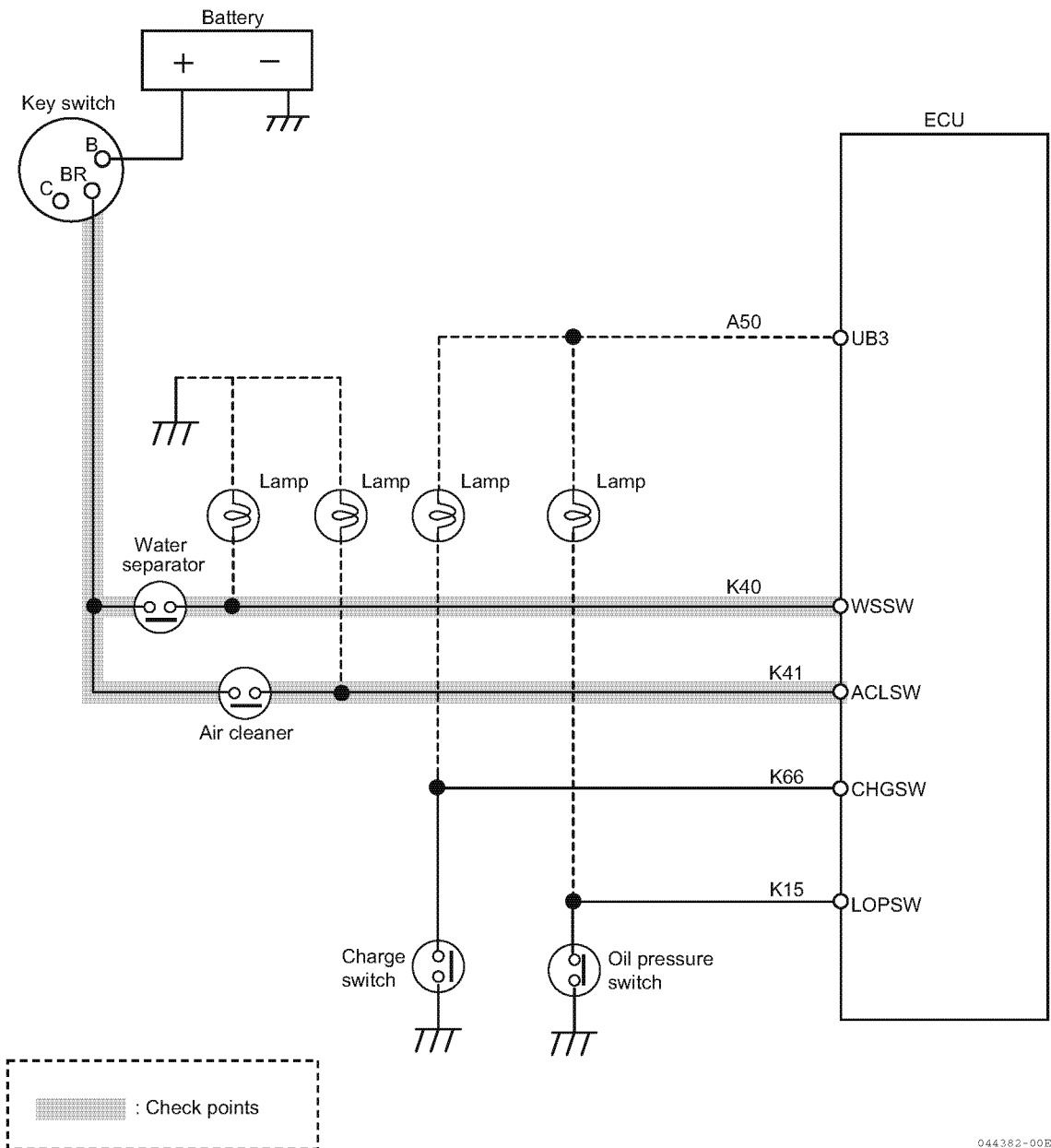

044382-00EN01

Note: See P325 for the ECU pin layout.

● **Work description**

1. Checking the conduction (contact input switch unit)

- 1-Turn off the ECU power.
- 2-Remove the wire-harness from each contact input switch.
- 3-Using a circuit tester, check the conduction between the contact input terminals of each switch while referring to the following table.

Item	Terminal No.	Conduction (between each switch terminal)	State
Air cleaner switch	K41	No	OK: Normal
		Yes	NG: Error
Water separator switch	K40	No	OK: Normal
		Yes	NG: Error

NG	Replace the contact input switch.
OK	Go to "Checking the conduction (contact input switch and wire-harness)".

2. Checking the conduction (contact input switch and wire-harness)

- 1-Connect the contact input switch and the wire-harness and remove the ECU and key switch terminal (BR) from the wire-harness.
- 2-Using a circuit tester to check the conduction between the ECU connector terminal and the key switch terminal (BR) of the wire-harness. For the number of the terminal that is checked, refer to 1. above.

NG	<ul style="list-style-type: none"> • A coupler failure between the contact input switch and the wire-harness may be caused. Replace the contact input switch. • Replace the wire-harness.
OK	Go to "Checking the operation of the contact input switch".

3. Checking the operation of the contact input switch

- 1-Connect all connectors (contact input switch, ECU, key switch terminal (BR)).
- 2-Connect SA-D, turn on the key switch, and then log in to SA-D.
- 3-Using SA-D's "Diagnosis Test: Digital input", monitor each indicated item, and check the ON/OFF display of the contact input switch under specific conditions.

Item	ON/OFF indication	State
Air cleaner switch	OFF (0)	OK: Normal
	ON (1)	NG: Error
Water separator switch	OFF (0)	OK: Normal
	ON (1)	NG: Error

NG	<ul style="list-style-type: none"> • The coupler between the wire-harness and the ECU may be defective. Replace the wire-harness. • Replace the ECU.
OK	Replace the ECU.

Post treatment related

■ DPF OP interface

Ash cleaning request

● Related DTC

P code	SPN/FMI	Name
P242F	3720/16	Ash cleaning request 1
P1420	3720/20	Ash cleaning request 2

● Workflow

Note: See "Work description" for work details. Go to "SA-D Operation Manual" for the SA-D operation.

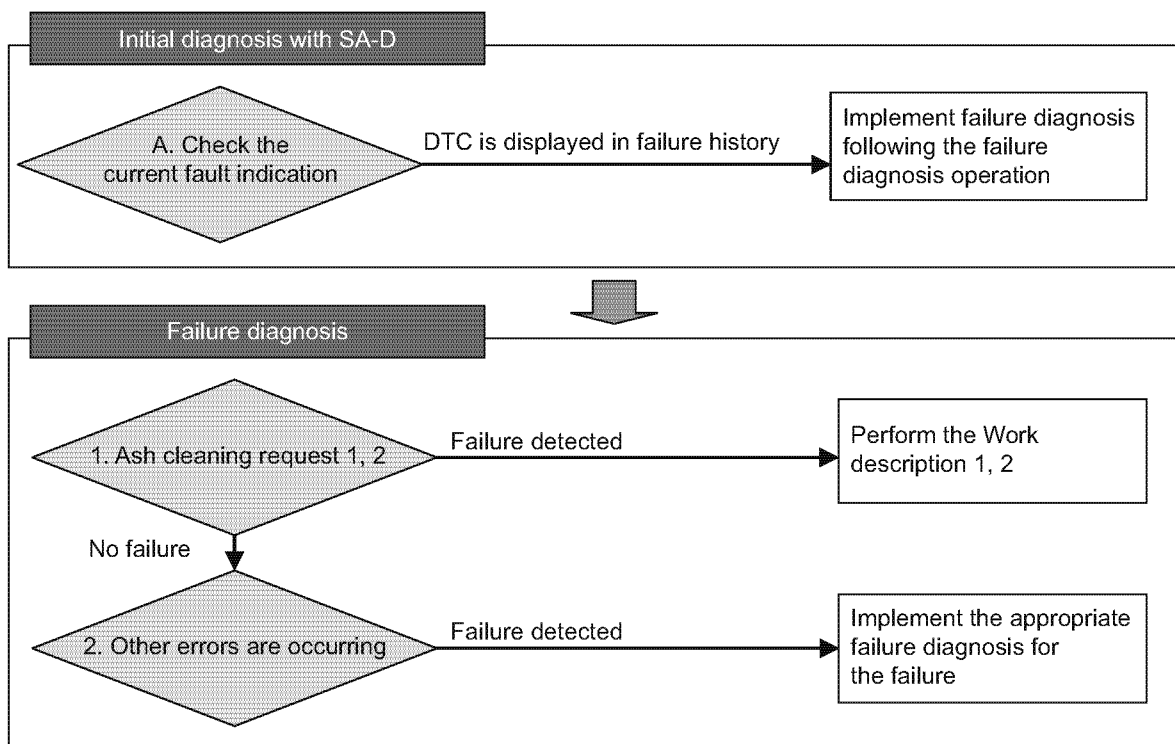

077776-00ENG0

● Work description

1. Clean (replace) the soot filter (SF).

Connect to SA-D, and clean (replace) the SF according to the SF replacement procedure.

See "SA-D Operation Manual" for details on SF replacement.

Consult your authorized YANMAR dealer or distributor for SF cleaning.

2. Make sure that Ash cleaning request 1 and 2 are not shown now.

Stationary regeneration standby

● Related DTC

P code	SPN/FMI	Name
P1421	3719/16	Stationary regeneration standby

● Workflow

Note: See "Work description" for work details. Go to "SA-D Operation Manual" for the SA-D operation.

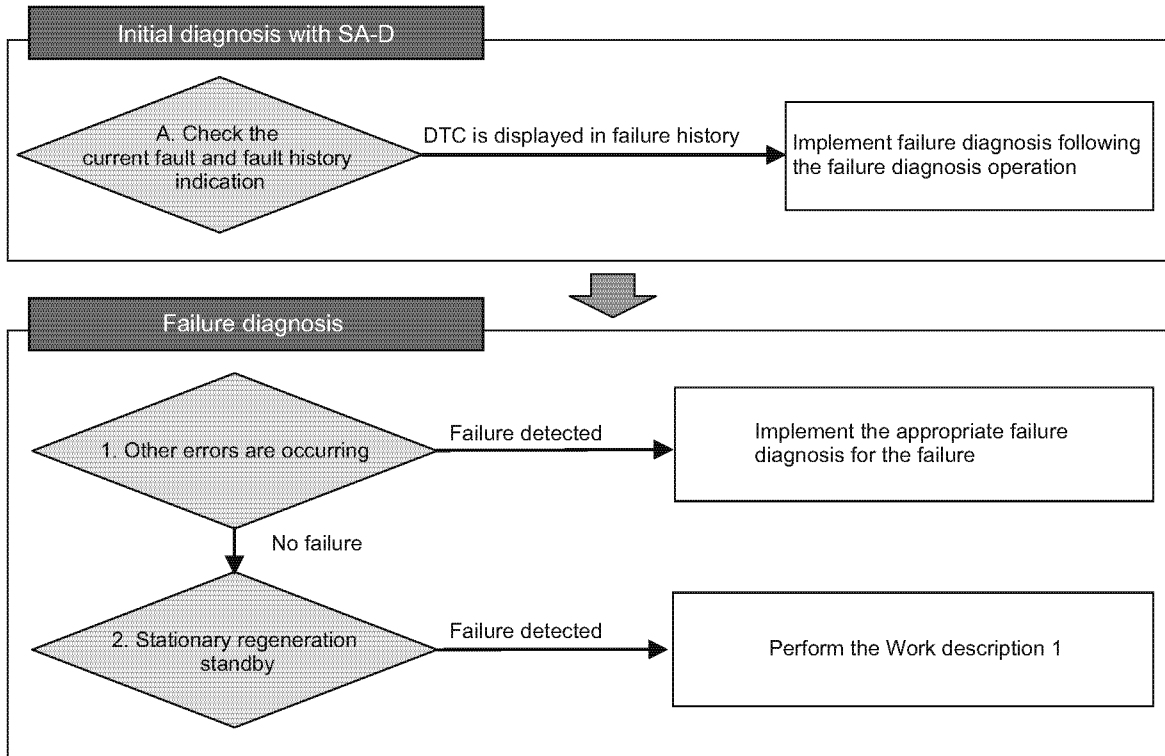

058963-00EN00

● Work description

1. PM may be accumulated, which required stationary regeneration.
Perform the stationary regeneration.

Recovery regeneration is inhibited

● Related DTC

P code	SPN/FMI	Name
P1446	3719/7	Recovery regeneration is inhibited

● Workflow

Note: See "Work description" for work details. Go to "SA-D Operation Manual" for the SA-D operation.

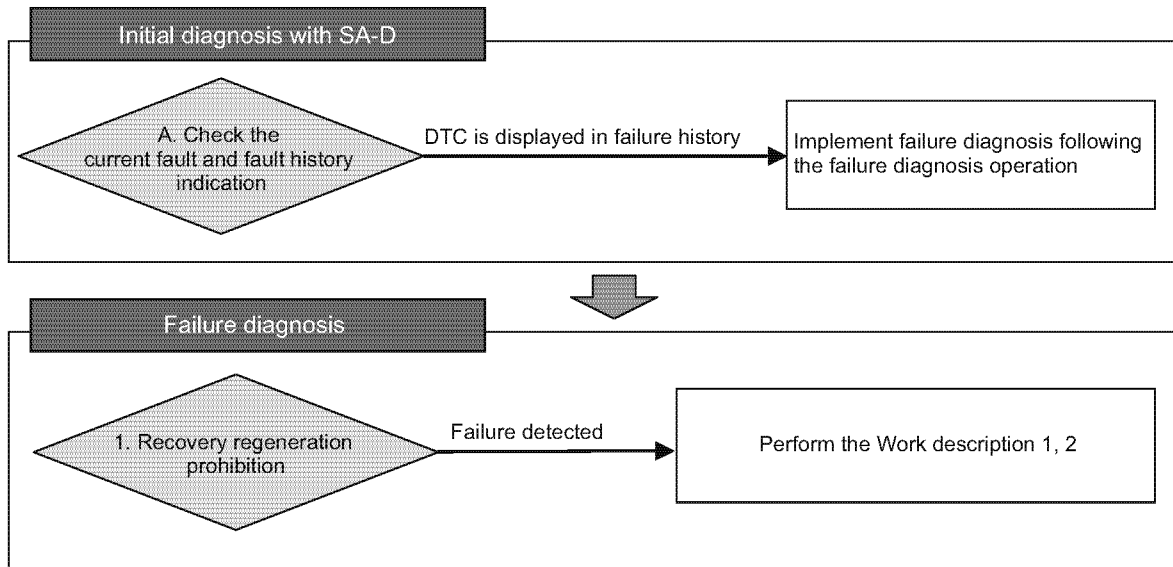

058964-00EN00

● Work description

1. Too much PM is accumulated in soot filter (SF). Replace the SF.
 Connect to SA-D, and clean (replace) the SF according to the SF replacement procedure.
 See "SA-D Operation Manual" for details on SF replacement.
2. Make sure that "recovery regeneration is inhibited" is not shown now.

Backup mode

● **Related DTC**

P code	SPN/FMI	Name
P1424	3719/0	Backup mode

● **Workflow**

Note: See "Work description" for work details. Go to "SA-D Operation Manual" for the SA-D operation.

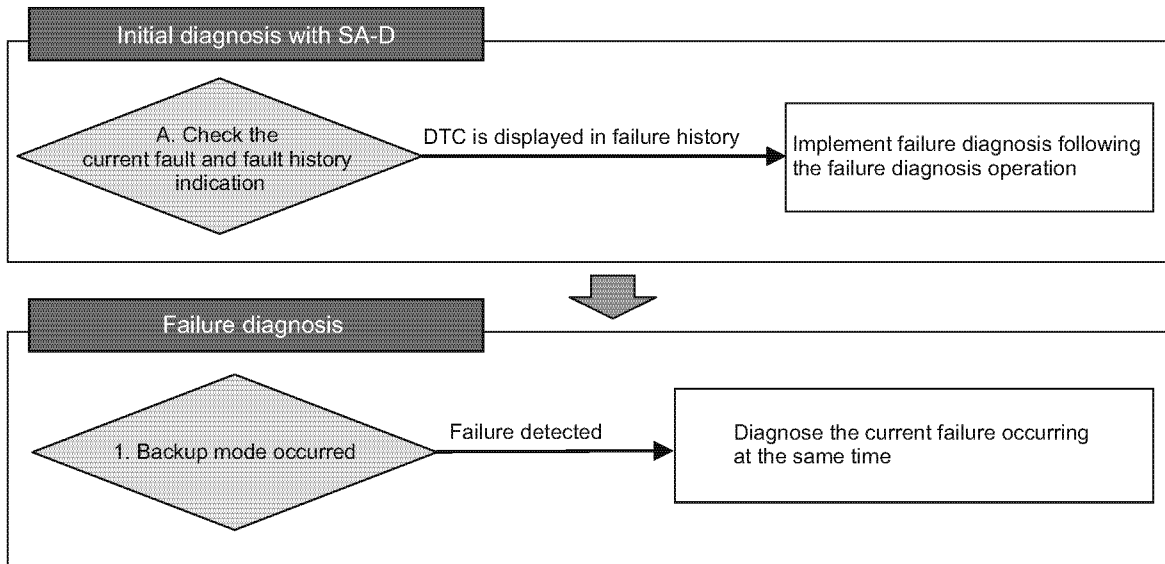

058965-00EN00

● **Work description**

When this error occurs, either of the following that shows the cause of backup mode is detected at the same time:

“Excessive PM accumulation (method C)”, “Excessive PM accumulation (method P)”, “Regeneration failure (stationary regeneration failure)”, and “Regeneration failure (stationary regeneration not performed)”.

What to check is different depending on the details of the failures detected at the same time. Perform failure diagnosis for them first.

■ DPF

Excessive PM accumulation

● Related DTC

P code	SPN/FMI	Name
P2463	522573/0	Excessive PM accumulation (Method C)
P1463	522574/0	Excessive PM accumulation (Method P)

● Workflow

Note: See "Work description" for work details. Go to "SA-D Operation Manual" for the SA-D operation.

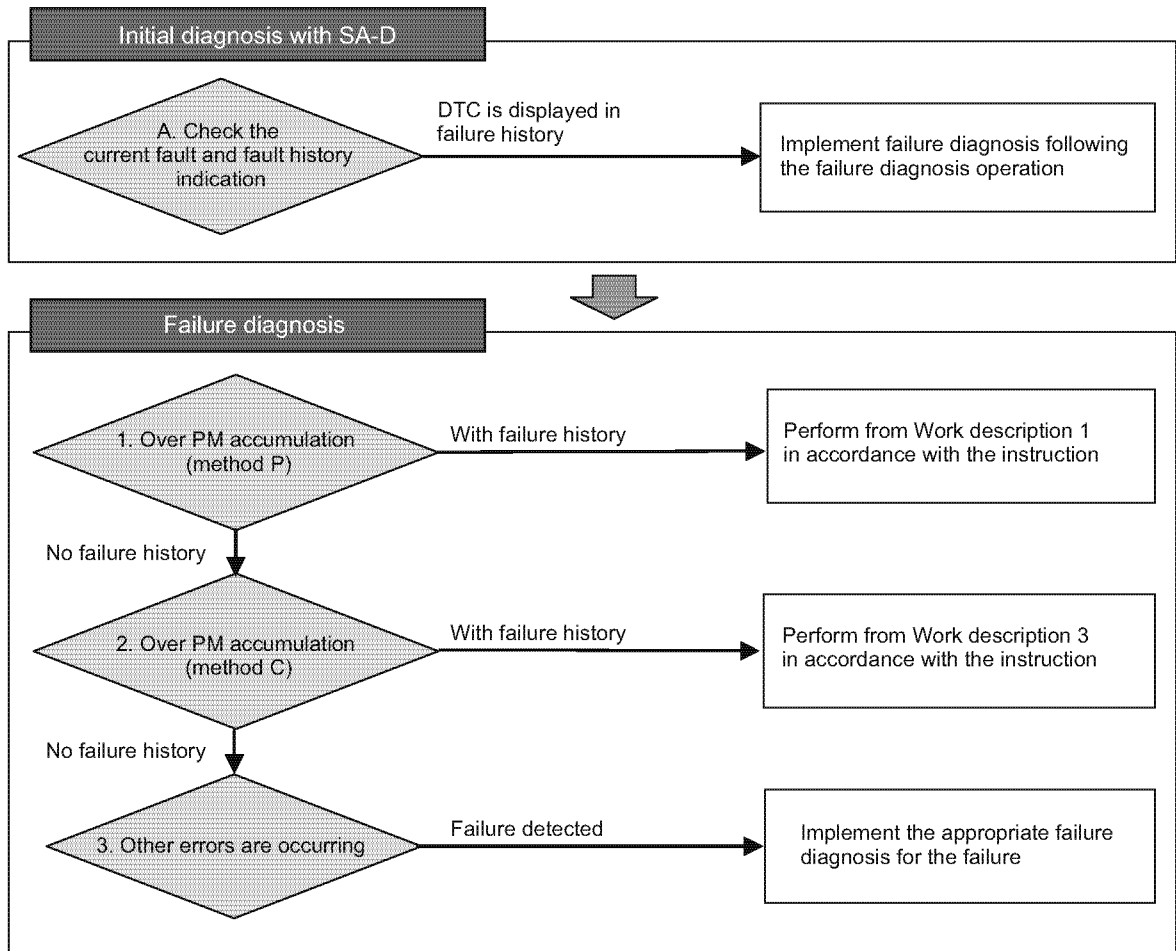

077760-00EN01

● Wire diagram

Follow the work procedure described later in “Work description”.

The diagram below is a wiring for YANMAR standard application. DPF operator interface differ depending on the application setting for each customer. Go through checkup following the system for the main machine.

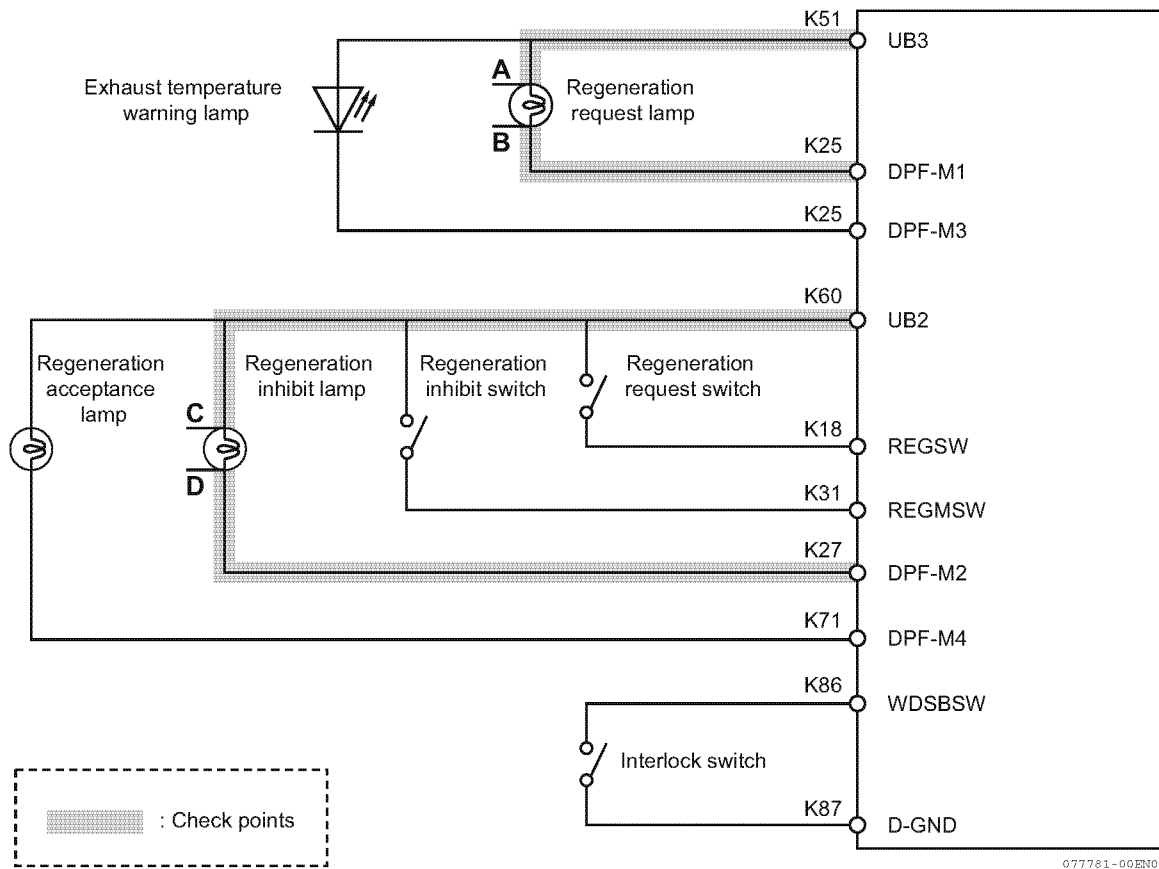

Note: See P325 for the ECU pin layout.

● Work description

1. Exhaust piping, pressure hose, and pressure pipe error

- 1- Make sure that there is nothing wrong (disconnections and damages) with the exhaust piping, pressure hose, or pressure pipe.

If there is something wrong with the exhaust pipe system	Fix the problem and proceed to step 2 of Work description.
If the exhaust pipe system is fine	Proceed to step 2 of Work description.

2. DPF differential pressure sensor system error

- 1- If “P2452: DPF differential pressure sensor differential pressure rise error” is occurring at the same time, refer to the procedure for “P2452: DPF differential pressure sensor differential pressure rise error”.

When DPF differential pressure sensor error is occurring	Fix the DPF differential pressure sensor system error, and then proceed to step 4 of Work description.
When DPF differential pressure sensor error is not occurring	Proceed to step 4 of Work description.

3. DPF intermediate temperature sensor system error

1- Make sure that “P0420: DPF intermediate temperature sensor temperature too low” is not occurring at the same time.

When DPF intermediate temperature sensor system error is occurring	Fix the DPF intermediate temperature sensor, and then proceed to step 4 of Work description.
When DPF intermediate temperature sensor system error is not occurring	Proceed to step 4 of Work description.

4. Ask the operator if he/she has been doing the stationary regeneration

If the stationary regeneration has been done	Proceed to step 5 of Work description.
If the stationary regeneration has not been done	Explain the operator how to use the stationary regeneration, and then proceed to step 5 of Work description.

5. Checking the DPF regeneration request lamp, DPF regeneration inhibit lamp, regeneration request switch, regeneration inhibit switch, and interlock switch

- Make sure all the lamps that are related to DPF regeneration are connected correctly. If they are not properly connected, notification may not reach the operator when regeneration is needed or regeneration is prohibited. The following procedure is for YANMAR’s standard wiring. For machines with different wirings, check the wiring according to the said machine.

1- Turn off the ECU power.

2- Remove the wire-harness from the ECU and each contact point output (lamp).

3- Using a circuit tester, check the conduction between the contact input terminals of each lamp while referring to the following table.

Item	Terminal No.		Conduction	State
DPF regeneration request lamp	K51	A (See wiring diagram)	Yes	OK: Normal
	K25	B (See wiring diagram)		
DPF regeneration inhibit lamp	K60	C (See wiring diagram)	No	NG: Error
	K27	D (See wiring diagram)		

- Checking the regeneration request switch, the regeneration inhibit switch, and the interlock switch

1- Connect the SA-D, operate the regeneration request switch, the regeneration inhibit switch, and the interlock switch to make sure that the contact ON/OFF switches properly.

See “SA-D Operation Manual” for details on SA-D operation.

Note: The ON/OFF can either be switched with contact points or CAN communication depending on the specifications.

2- DPF regeneration inhibit switch: Inhibited

When the inhibited state is continued, turn off the DPF regeneration inhibit switch.

If there is something wrong with the lamp or switch	Replace the wire-harness, and then proceed to step 6 of Work description.
If the lamp and switch are fine	Proceed to step 6 of Work description.

6. Perform the recovery regeneration. See “SA-D Operation Manual” for details on recovery regeneration.

After the recovery regeneration, check that the failure has been solved.

Regeneration failure 1

● Related DTC

P code	SPN/FMI	Name
P2458	522575/7	Regeneration failure (stationary regeneration failure)
P1445	3719/9	Recovery regeneration failure

● Workflow

Note: See "Work description" for work details. Go to "SA-D Operation Manual" for the SA-D operation.

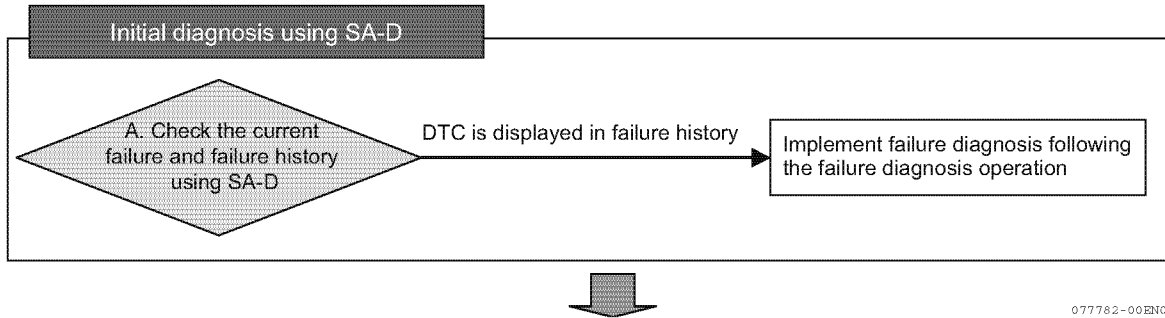

077782-00EN00

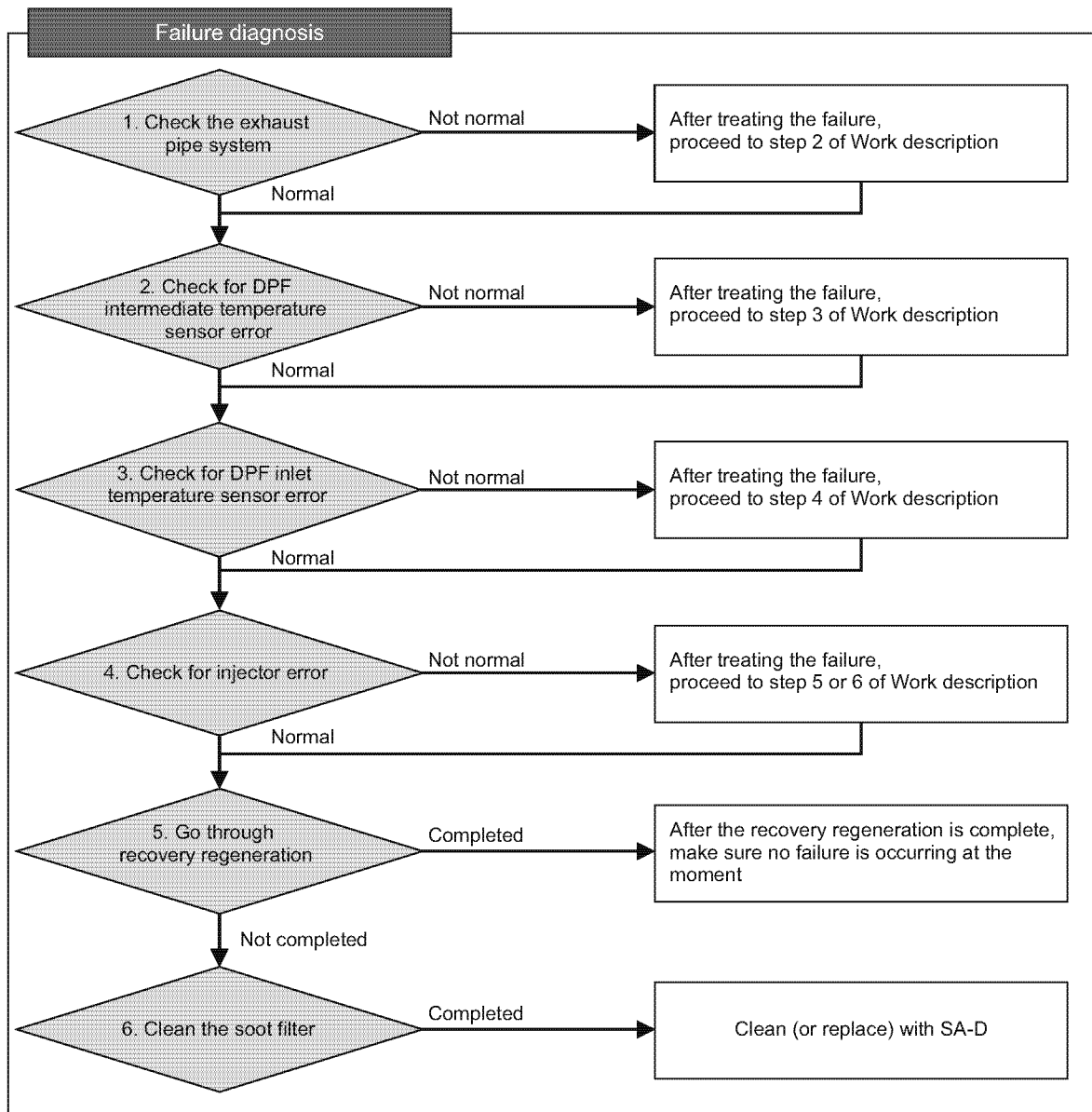

077783-00ENG0

● Work description

1. Exhaust piping, pressure hose, and pressure pipe error

- 1- Make sure that there is nothing wrong (disconnections and damages) with the exhaust piping, pressure hose, or pressure pipe.

If there is something wrong with the exhaust pipe system	Fix the problem and proceed to step 2 of Work description.
If the exhaust pipe system is fine	Proceed to step 2 of Work description.

2. DPF intermediate temperature sensor system error

- 1- Make sure that “P0420: DPF intermediate temperature sensor temperature too low” is not occurring at the same time.

When DPF intermediate temperature sensor system error is occurring	Fix the DPF intermediate temperature sensor, and then proceed to step 3 of Work description.
When DPF intermediate temperature sensor system error is not occurring	Proceed to step 3 of Work description.

3. DPF inlet temperature sensor error

- 1- Check the resistance value of the DPF inlet temperature sensor with reference to the failure diagnosis items in “P1427: DPF inlet temperature sensor error (voltage low)”, etc.

If the resistance value of the DPF inlet temperature sensor is out of the range	Fix the DPF inlet temperature sensor failure, and then proceed to step 4 of Work description.
If the resistance value of the DPF inlet temperature sensor is within the range	Proceed to step 4 of Work description.

4. Injector failure

- 1- Remove the injector, and replace the nozzle.

If there is something wrong such deposits	Fix the injector failure in accordance with the Service Manual. If the recovery regeneration (optional) function is equipped, proceed to step 5 of Work description. If the recovery regeneration (optional) function is not equipped, proceed to step 6 of Work description.
If the injector works properly	Install the injector again. If the recovery regeneration (optional) function is equipped, proceed to step 5 of Work description. If the recovery regeneration (optional) function is not equipped, proceed to step 6 of Work description.

5. Perform the recovery regeneration. There are two ways to perform the recovery regeneration.

- SA-D Changing Operation Manual
- See the long press of switch

The long press time varies according to models. Consult your authorized YANMAR industrial engine dealer or distributor for details.

If the recovery regeneration is completed	After the recovery regeneration, check that the failure has been solved.
If the recovery regeneration is not completed	After recovery regeneration is completed, and if the recovery regeneration is failed, proceed to step 6 of Work description.

6. Clean the soot filter (SF)

Using SA-D, clean (replace) the SF. See “SA-D Operation Manual” for details.

Note: Replace the DPF (DOC + SF), when “P1445: Recovery regeneration failure” occurs again.

Regeneration failure 2

● Related DTC

P code	SPN/FMI	Name
P2459	522577/11	Regeneration failure (stationary regeneration not performed)

● Workflow

Note: See "Work description" for work details. Go to "SA-D Operation Manual" for the SA-D operation.

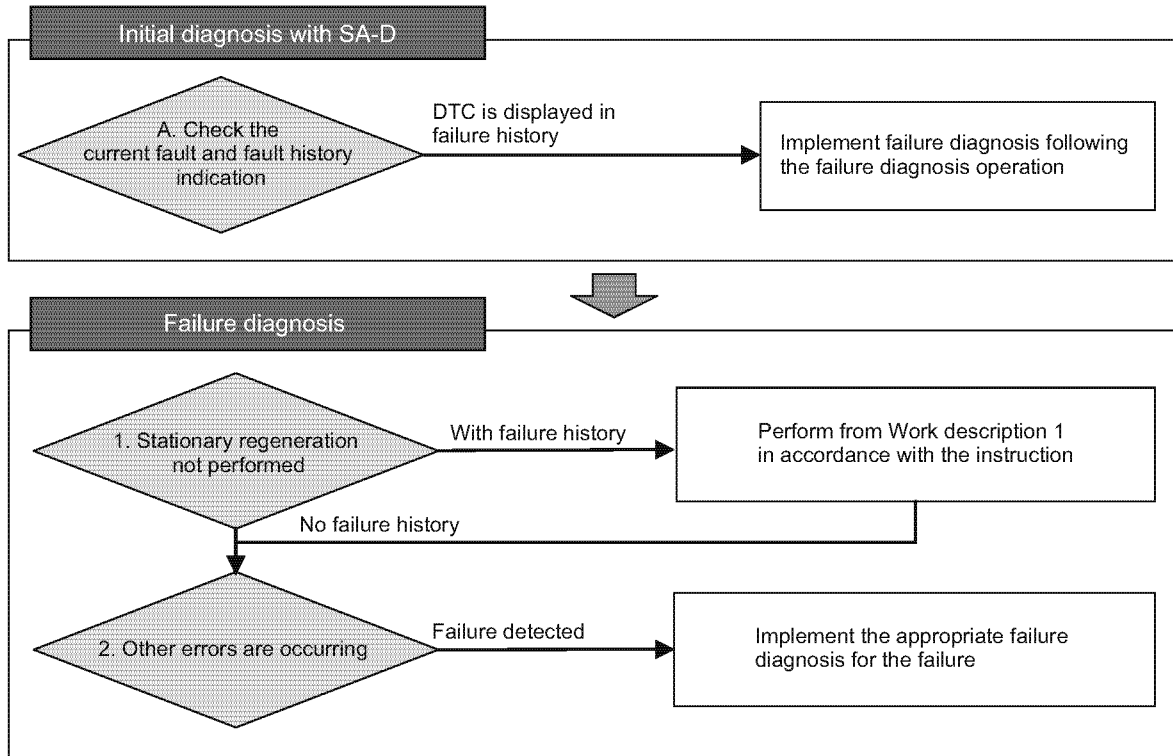

058961-00EN00

● Wire diagram

Follow the work procedure described later in “Work description”.

The diagram below is a wiring for YANMAR standard application. DPF operator interface differ depending on the application setting for each customer. Go through checkup following the system for the driven machine.

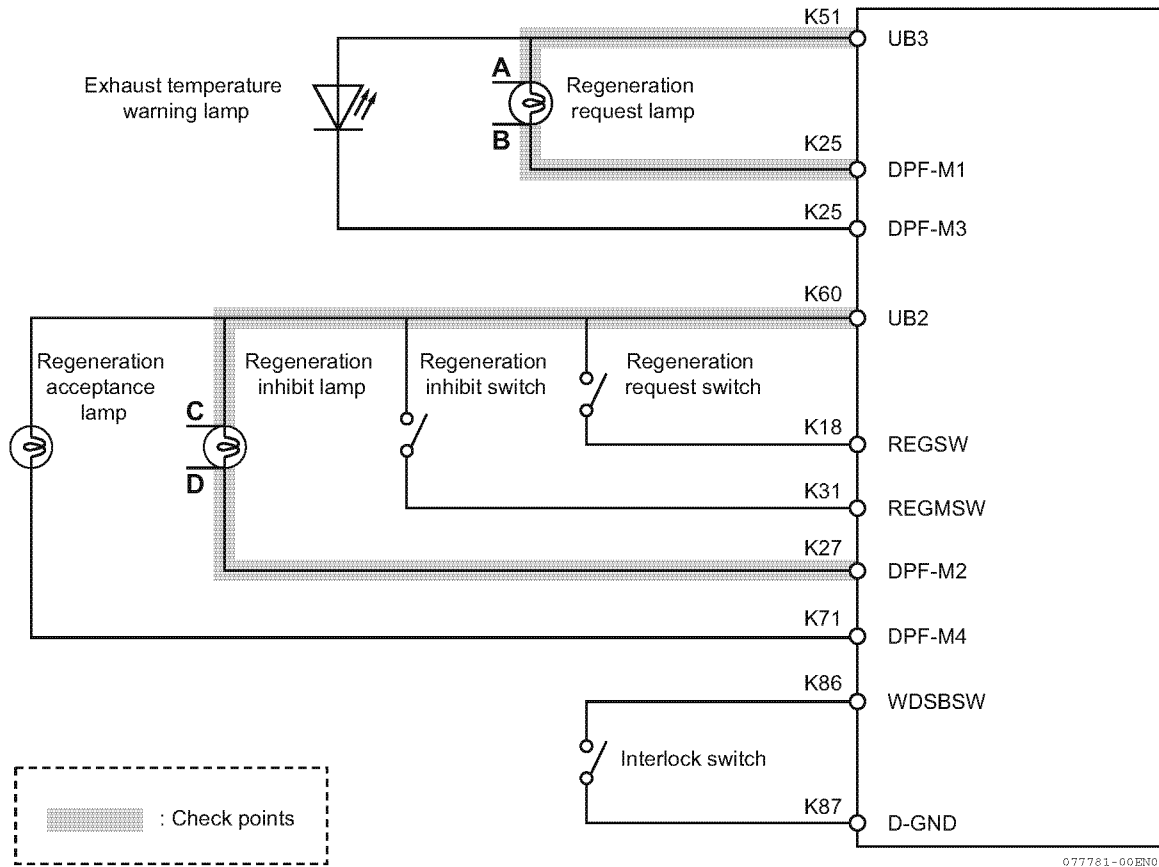

Note: See P325 for the ECU pin layout.

● **Work description**

1. Regeneration for the stationary regeneration request is not performed

- Ask the operator if the regeneration request lamp and failure indication lamp (Fail lamp or Amber warning lamp) was on before the failure occurred.

Explain to the customer that stationary regeneration is needed when the lamp turns on.

- If they know the necessity of the stationary regeneration, but still this error occurs, there might be some thing wrong with the lamp or switch itself. Make sure that the connections of the switches and lamps related to the DPF regeneration are as indicated on the above diagram.

Note: The ON/OFF can either be switched with contact points or CAN communication depending on the specifications.

- Checking the conduction of the lamp related to the regeneration (contact output only)

1- Turn off the ECU power.

2- Remove the wire-harness from the ECU and each contact point output (lamp).

3- Using a circuit tester, check the conduction between the contact input terminals of each lamp while referring to the following table.

Item	Terminal No.		Conduction	State
DPF regeneration request lamp	K51	A (See wiring diagram)	Yes	OK: Normal
	K25	B (See wiring diagram)		
DPF regeneration inhibit lamp	K60	C (See wiring diagram)	No	NG: Error
	K27	D (See wiring diagram)		

- Checking the regeneration request switch, the regeneration inhibit switch, and the interlock switch

1- Connect the SA-D, operate the regeneration request switch, the regeneration inhibit switch, and the interlock switch to make sure that the contact ON/OFF switches properly.

See "SA-D Operation Manual" for details on SA-D operation.

2- DPF regeneration inhibit switch: Inhibited

When the inhibited state is continued, turn off the DPF regeneration inhibit switch.

If the conduction in switch or lamp is failed	Replace the wire-harness, and then proceed to step 2 of Work description.
When DPF differential pressure sensor error is not occurring	Proceed to step 2 of Work description.

2. Perform the recovery regeneration. There are two ways to perform the recovery regeneration

- SA-D Changing Operation Manual

- See the long press of switch

The long press time varies according to models. Consult your authorized YANMAR industrial engine dealer or distributor for details.

CRS (common rail system) related

■ Injector

Disconnection of the injector and coil short circuit

● Related DTC

P code	SPN/FMI	Name
P0201	654/5	Injector (No. 1 cylinder) disconnection (injector-specific)
P0202	653/5	Injector (No. 2 cylinder) disconnection (injector-specific)
P0203	652/5	Injector (No. 3 cylinder) disconnection (injector-specific)
P0204	651/5	Injector (No. 4 cylinder) disconnection (injector-specific)
P0262	654/6	Injector (No. 1 cylinder) coil short circuit
P0265	653/6	Injector (No. 2 cylinder) coil short circuit
P0268	652/6	Injector (No. 3 cylinder) coil short circuit
P0271	651/6	Injector (No. 4 cylinder) coil short circuit

● Workflow

Note: See "Work description" for work details. Go to "SA-D Operation Manual" for the SA-D operation.

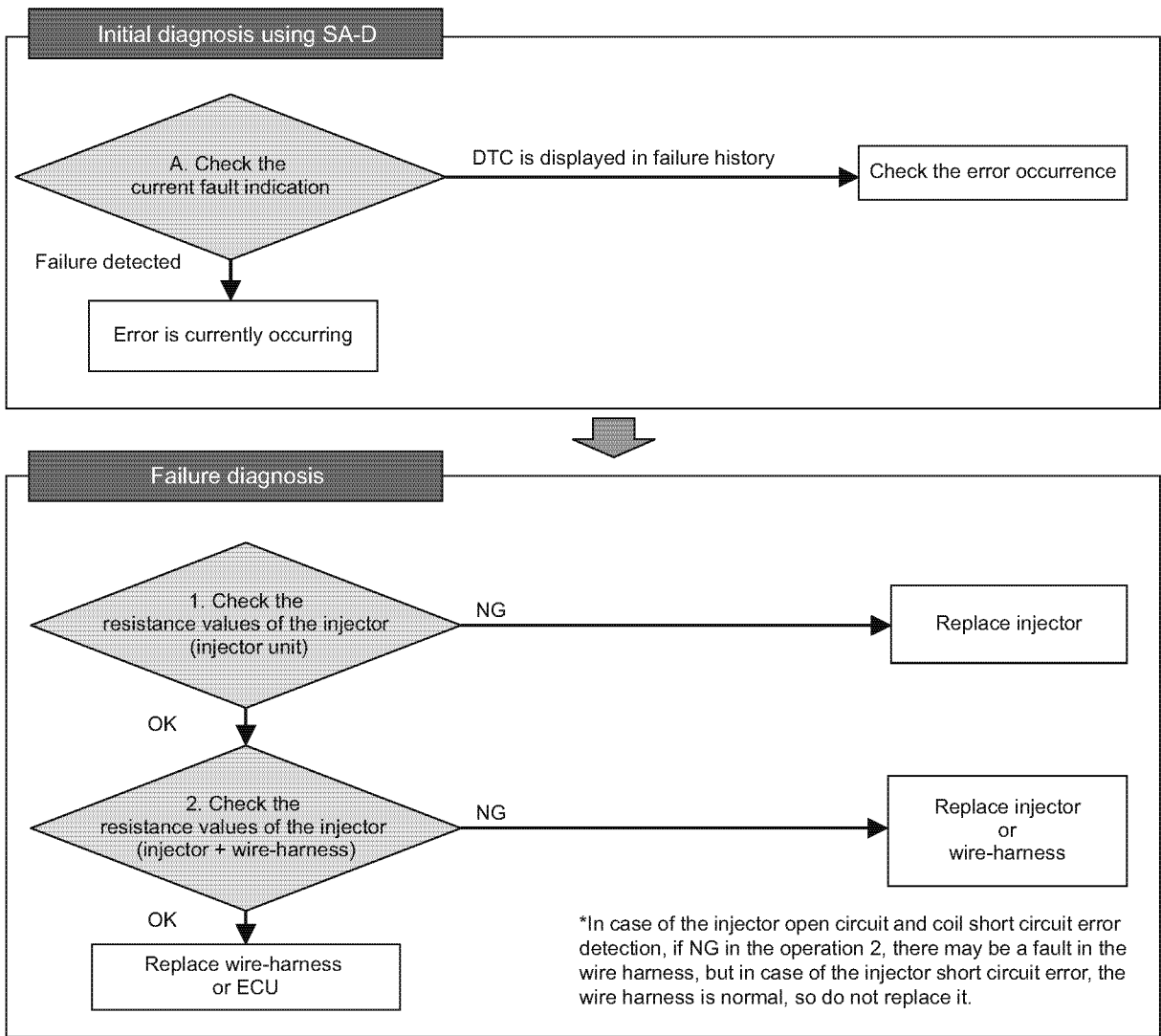

044393-01EN01

● Wire diagram

The wiring of the injector differs depending on the number of cylinders of each engine.

When diagnosing the wire-harness, refer to the diagram below to check the correct connection.

3-Cylinder engine

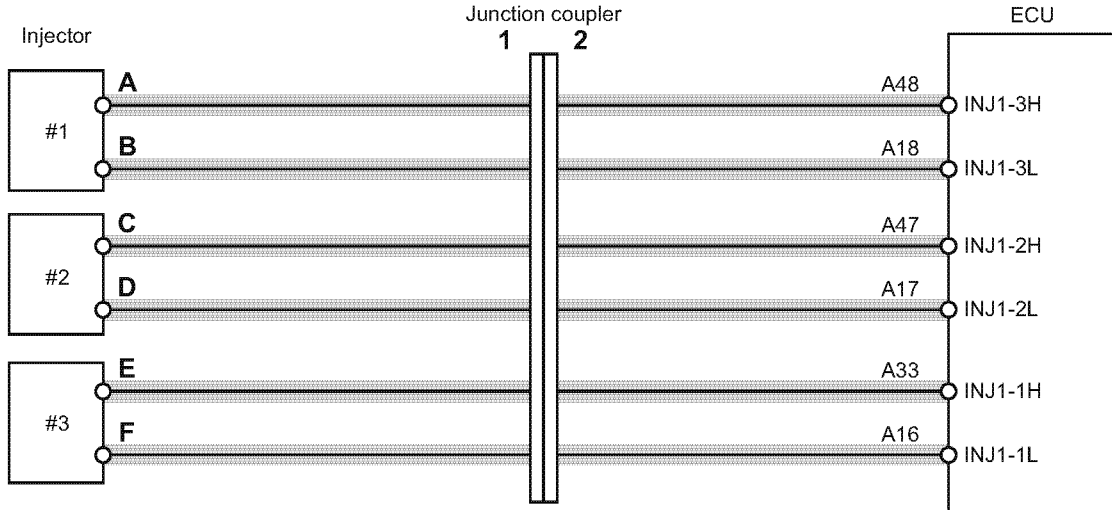

077785-00EN00

Note: #1 to #3 are numbers counted from the flywheel side. Note that it is different from the ECU circuit name.

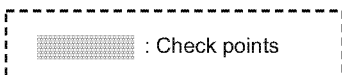
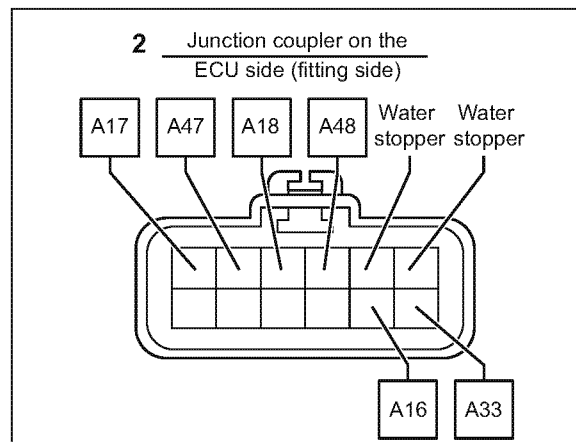
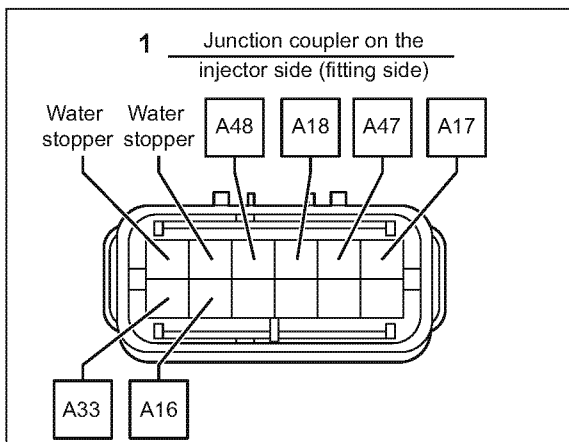
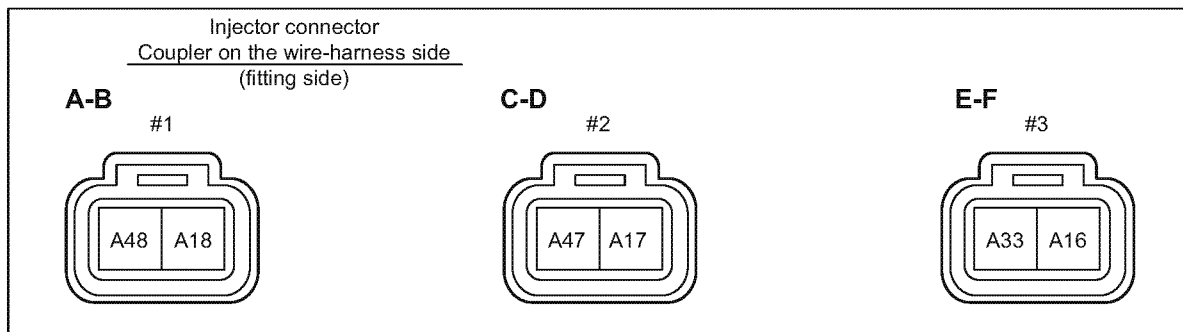

077788-00EN00

Note: See P325 for the ECU pin layout.

4-Cylinder engine

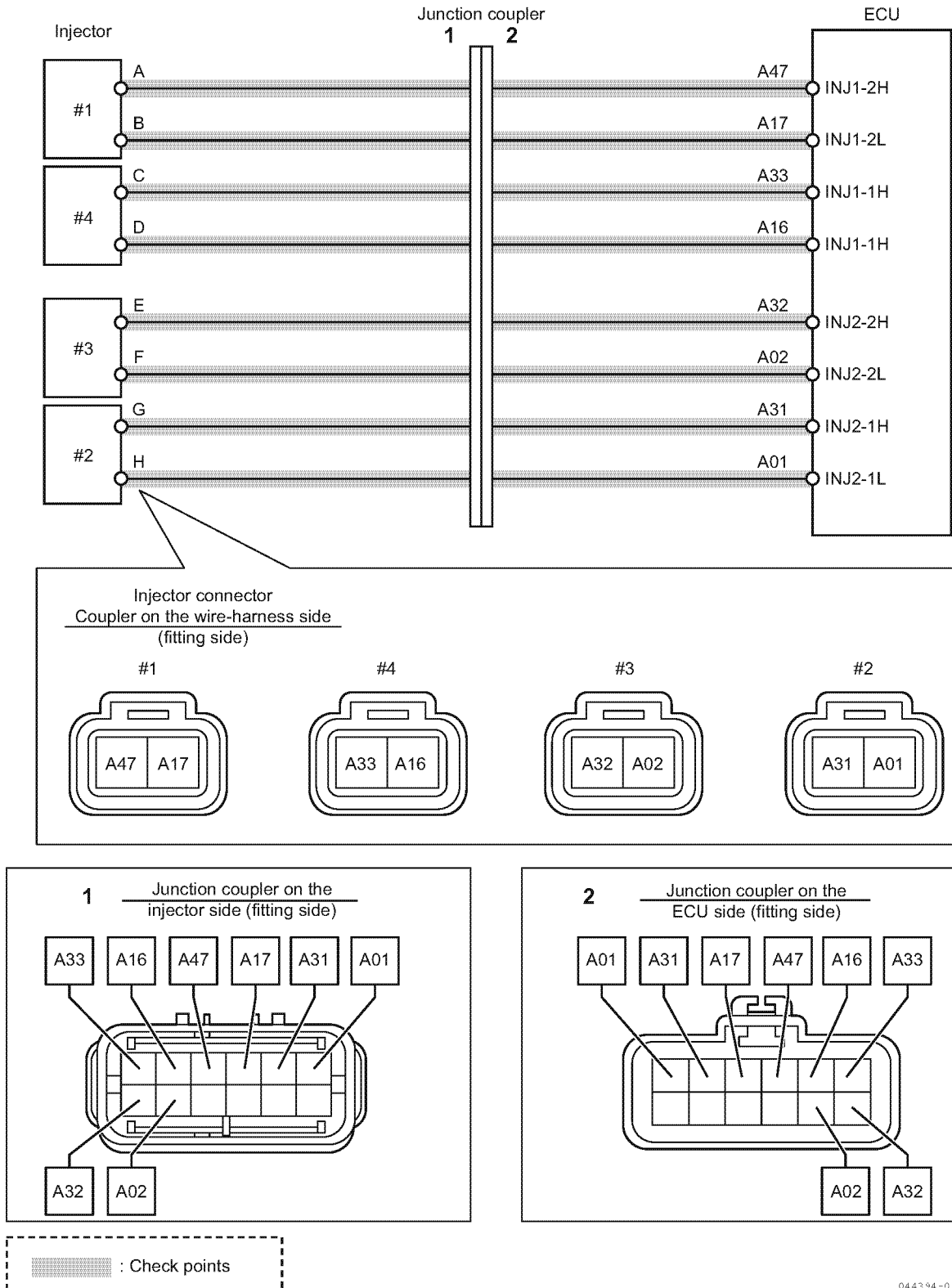

044394-01EN00

- Note**
- See P325 for the ECU pin layout.
 - Injector numbers (#1-#4) are counted up from the flywheel side. Be careful, it is different from the ECU circuit name.

● **Work description**

1. Checking the injector resistance value (injector unit)

1-Remove the injector from the wire-harness.

2-Using a circuit tester, measure the resistance value (total resistance) of the part which detected an error between the injector terminals A and B, C and D, E and F, or G and H.

Reference: Injector's overall resistance value

Terminal	Specifications
Between the injector terminals	255 ± 40 mΩ

NG	Replace the injector.
OK	Go to "Checking the resistance values of the injector (injector and wire-harness)".

2. Checking the resistance values of the injector (injector and wire-harness)

● Junction coupler not connected

1-Connect the injector and the wire-harness, and remove the ECU from the wire-harness. However, see the above wiring diagram to remove the wire-harness of junction coupler (2) from the wire-harness of junction coupler (1).

2-Using a circuit tester, measure the resistance value (overall resistance value) between the junction coupler (1) side wire-harness connectors A47 and A17, A33 and A16, A32 and A02, and A31 and A01.

Note: See "Reference: Injector's overall resistance value".

NG	<ul style="list-style-type: none"> The coupler between the injector and the wire-harness may be defective. Replace the injector. Replace the wire-harness.
OK	Go to "While junction coupler is connected".

● While junction coupler is connected

1-Connect the injector and the wire-harness, and remove the ECU from the wire-harness. However, see the above wiring diagram to connect the wire-harness of junction coupler (2) to the wire-harness of junction coupler (1).

2-Using a circuit tester, measure the resistance value (overall resistance value) between the ECU side wire-harness connectors A47 and A17, A33 and A16, A32 and A02, and A31 and A01.

Note: See "Reference: Injector's overall resistance value".

NG	The junction coupler may be defective. Replace the wire-harness.
OK	<ul style="list-style-type: none"> The coupler between the wire-harness and the ECU may be defective. Replace the wire-harness. Replace the ECU.

Injector short circuit**● Related DTC**

P code	SPN/FMI	Name
P1262	654/3	Injector (No. 1 cylinder) short circuit
P1265	653/3	Injector (No. 2 cylinder) short circuit
P1268	652/3	Injector (No. 3 cylinder) short circuit
P1271	651/3	Injector (No. 4 cylinder) short circuit
P1146	2797/6	Injector drive circuit (Bank 1) short circuit
P1149	2798/6	Injector drive circuit (Bank 2) short circuit

● Workflow

Refer to "Disconnection of the injector and coil short circuit"

● Wire diagram

Refer to "Disconnection of the injector and coil short circuit"

● **Work description**

1. Checking the injector resistance value (injector unit)

1-Remove the injector from the wire-harness.

2-Using a circuit tester, measure the resistance value (overall resistance value) between injector terminals A and B, C and D, E and F, and G and H.

Reference: Injector's overall resistance value

Terminal	Specifications
Between the injector terminals	TBD

NG	Replace the injector
OK	Go to "Checking the resistance values of the injector (injector and wire-harness)".

2. Checking the resistance values of the injector (injector and wire-harness)

● Junction coupler not connected

1-Connect the injector and the wire-harness, and remove the ECU from the wire-harness. However, see the above wiring diagram to remove the wire-harness of junction coupler (2) from the wire-harness of junction coupler (1).

2-Using a circuit tester, measure the resistance value (overall resistance value) between the junction coupler (1) side wire-harness connectors A47 and A17, A33 and A16, A32 and A02, and A31 and A01.

Note: See "Reference: Injector's overall resistance value".

NG	Replace the wire-harness.
OK	Go to "While junction coupler is connected".

● While junction coupler is connected

1-Connect the injector and the wire-harness, and remove the ECU from the wire-harness. However, see the above wiring diagram to connect the wire-harness of junction coupler (2) to the wire-harness of junction coupler (1).

2-Using a circuit tester, measure the resistance value (overall resistance value) between the ECU side wire-harness connectors A47 and A17, A33 and A16, A32 and A02, and A31 and A01.

Note: See "Reference: Injector's overall resistance value".

NG	Replace the wire-harness.
OK	<ul style="list-style-type: none"> • The coupler between the wire-harness and the ECU may be defective. Replace the wire-harness. • Replace the ECU.

■ High-pressure pump (MPROP)

● Related DTC

P code	SPN/FMI	Name
P1641	522571/3	SCV (MPROP) L side VB short circuit
P1643	522571/6	SCV (MPROP) L side GND short circuit
P0629	633/3	SCV (MPROP) H side VB short circuit
P1642	633/6	SCV (MPROP) H side GND short circuit
P064A	633/2	SCV (MPROP) H side - L side short circuit
P0627	633/5	SCV (MPROP) disconnection
P025B	633/11	SCV (MPROP) failure diagnosis information not received
P1645	522572/11	SCV (MPROP) Pump overload error
P062A	522572/6	SCV (MPROP) Drive current (high level)

● Workflow

Note: See "Work description" for work details. Go to "SA-D Operation Manual" for the SA-D operation.

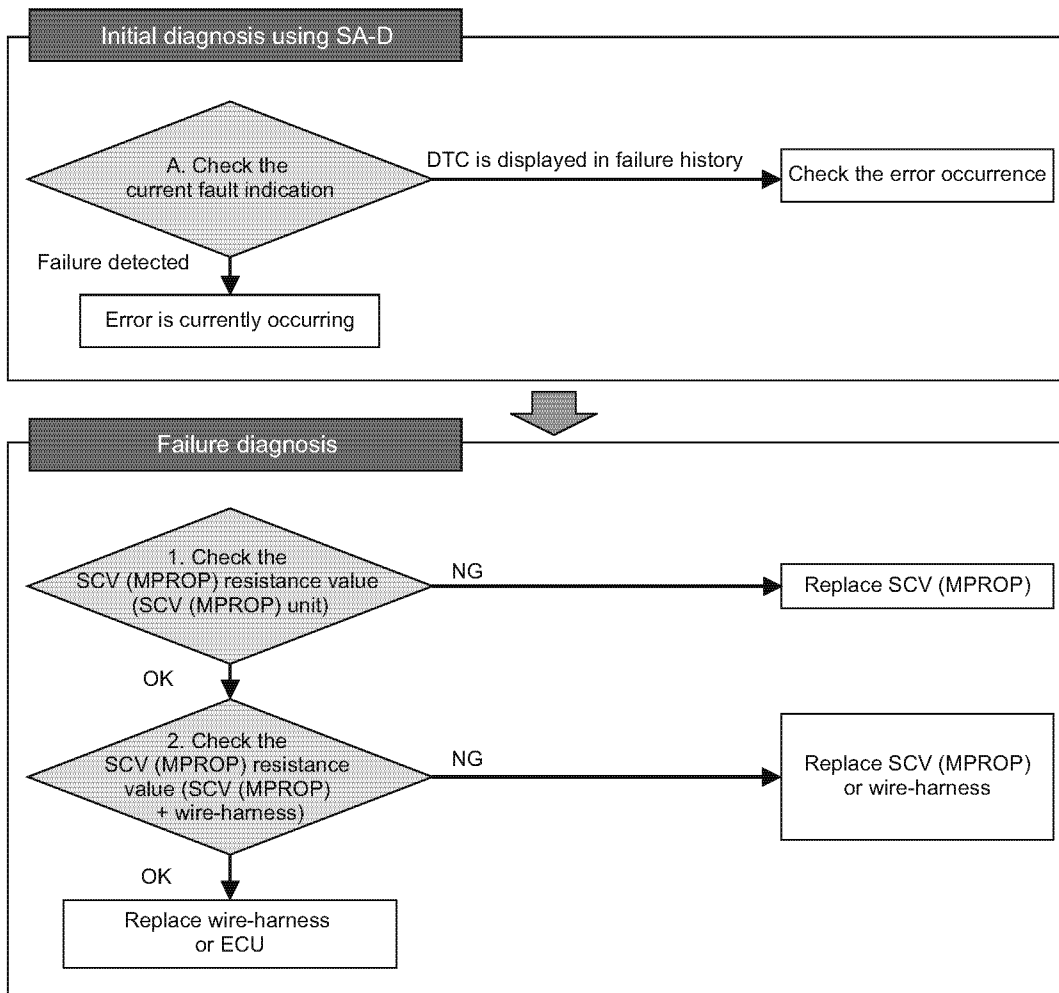

050503-00EN01

● Wiring diagram

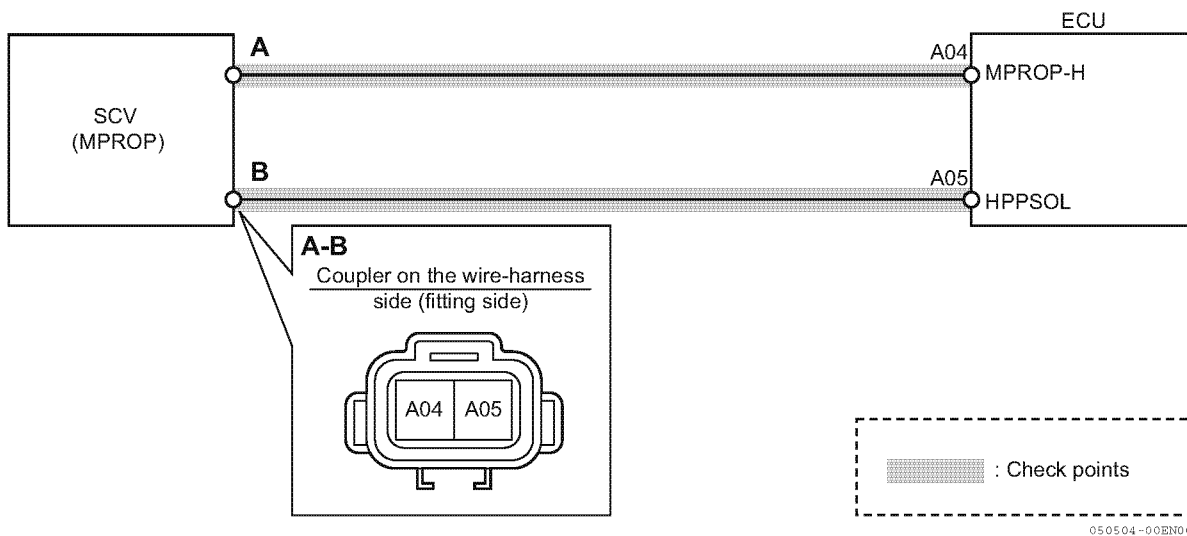

Note: See P325 for the ECU pin layout.

● Work description

1. Checking the SCV (MPROP) resistance value (SCV (MPROP) unit)

1- Remove the SCV (MPROP) from the wire-harness.

2- Using a circuit tester, measure the resistance value (overall resistance value) between SCV (MPROP) terminals A and B.

Reference: SCV (MPROP)'s overall resistance value

Terminal	Specifications
Between the SCV (MPROP) terminals	2.60 - 3.15 Ω

NG	Replace the SCV (MPROP).
OK	Go to "Checking the SCV (MPROP) resistance value (SCV (MPROP) + wire-harness)".

2. Checking the SCV (MPROP) resistance value (SCV (MPROP) + wire-harness)

1- Connect the SCV (MPROP) and the wire-harness. Remove the ECU from the wire-harness.

2- Using a circuit tester, measure the resistance value between ECU wire-harness connectors A04 and A05.

Note: See the above "Reference: SCV (MPROP)'s overall resistance value".

NG	The wire-harness may be defective. Replace the wire-harness.
OK	Replace the ECU.

Actuator

■ Intake throttle drive circuit

● Related DTC

P code	SPN/FMI	Name
P0660	2950/5	No-load of throttle valve drive H bridge circuit
P1660	2950/6	Overload on the drive H bridge circuit of throttle valve
P1658	2950/3	Power short circuit of throttle valve drive H bridge output 1
P1661	2951/3	Power short circuit of throttle valve drive H bridge output 2
P1659	2950/4	GND short circuit of throttle valve drive H bridge output 1
P1662	2951/4	GND short circuit of throttle valve drive H bridge output 2

● Workflow

Note: See "Work description" for work details. Go to "SA-D Operation Manual" for the SA-D operation.

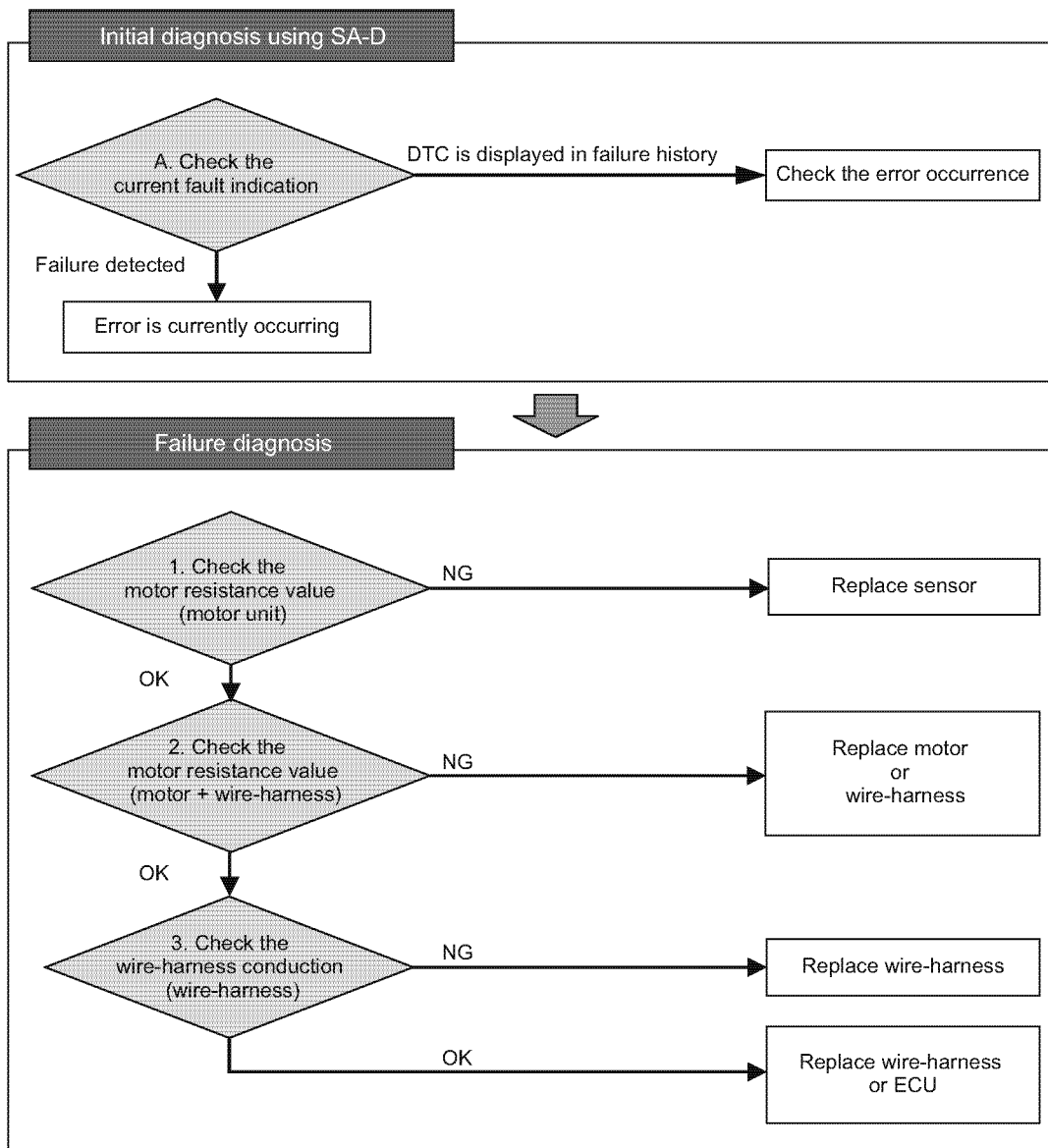

045710-00EN01

● Wiring diagram

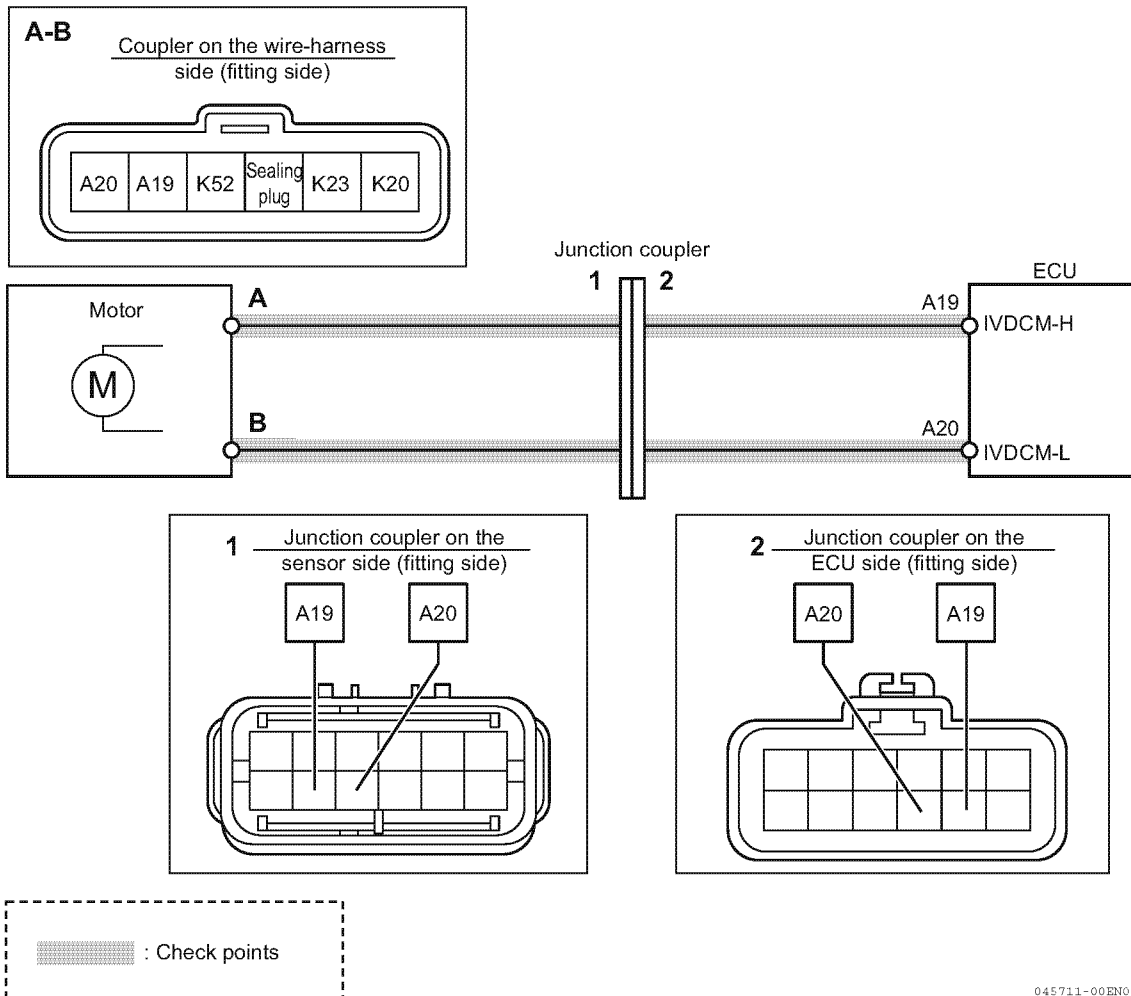

045711-00EN00

Note: See P325 for the ECU pin layout.

● **Work description**

1. Checking the motor resistance value (motor unit)

1- Remove the motor from the wire-harness.

2- Using a circuit tester, measure the resistance value (overall resistance value) between motor terminals A and B.

Reference: Overall resistance value of motor

Terminal	Specifications
Between terminal A and B	Under investigation
NG	Replace the motor.
OK	Go to "Checking the motor resistance value (motor + wire-harness)".

2. Checking the motor resistance value (motor + wire-harness)

1- Connect the motor and the wire-harness. Remove the ECU from the wire-harness.

2- Using a circuit tester, measure the resistance value (overall resistance value) between ECU wire-harness connectors A19 and A20.

Note: See the above "Reference: Overall resistance value of motor".

No	<ul style="list-style-type: none"> • A coupler failure between the motor and the wire-harness may be caused. Replace the motor. • Replace the wire-harness.
Applied	Go to "Checking the wire-harness conduction".

3. Checking the wire-harness conduction

1- Remove the wire-harness from the motor and ECU. However, connect the junction coupler.

2- While referring to the P325 "ECU pin layout diagram", check the conduction of the wire-harness between terminals 1 and 2 in the chart below.

Detection error	Check method
No-load of throttle valve drive H bridge circuit	Perform the check pattern 1
Power short circuit of throttle valve drive H bridge output 1	Perform the check pattern 2
Power short circuit of throttle valve drive H bridge output 2	Perform the check pattern 3
GND short circuit of throttle valve drive H bridge output 1	Perform the check pattern 4
GND short circuit of throttle valve drive H bridge output 2	Perform the check pattern 5

Reference: Intake throttle drive circuit conduction check pattern 1

Terminal 1 (Wire-harness connector on ECU side)	Terminal 2 (Wire-harness connector on DC motor side)	Conduction	State
A19	Motor terminal A	Yes	OK: Normal
		No	NG: Error
A20	Motor terminal B	Yes	OK: Normal
		No	NG: Error

Reference: Intake throttle drive circuit conduction check pattern 2

Terminal 1 (Wire-harness connector on ECU side)	Terminal 2 (Wire-harness connector on ECU side)	Conduction	State
A19	VB terminal	Yes	NG: Error
		No	OK: Normal

Reference: Intake throttle drive circuit conduction check pattern 3

Terminal 1 (Wire-harness connector on ECU side)	Terminal 2 (Wire-harness connector on ECU side)	Conduction	State
A20	VB terminal	Yes	NG: Error
		No	OK: Normal

Reference: Intake throttle drive circuit conduction check pattern 4

Terminal 1 (Wire-harness connector on ECU side)	Terminal 2 (Wire-harness connector on ECU side)	Conduction	State
A19	GND terminal	Yes	NG: Error
		No	OK: Normal

Reference: Intake throttle drive circuit conduction check pattern 5

Terminal 1 (Wire-harness connector on ECU side)	Terminal 2 (Wire-harness connector on ECU side)	Conduction	State
A20	GND terminal	Yes	NG: Error
		No	OK: Normal

NG	Wire-harness disconnection or short circuit. Replace the wire-harness.
OK	<ul style="list-style-type: none"> • A coupler failure between the ECU and the wire-harness may be caused. Replace the wire-harness. • Replace the ECU.

■ Intake throttle

● Related DTC

P code	SPN/FMI	Name
P02E4	2950/7	Throttle valve sticking (sticking open)
P02E5	2951/7	Throttle valve sticking (sticking closed)

● Workflow

Note: See "Work description" for work details. Go to "SA-D Operation Manual" for the SA-D operation.

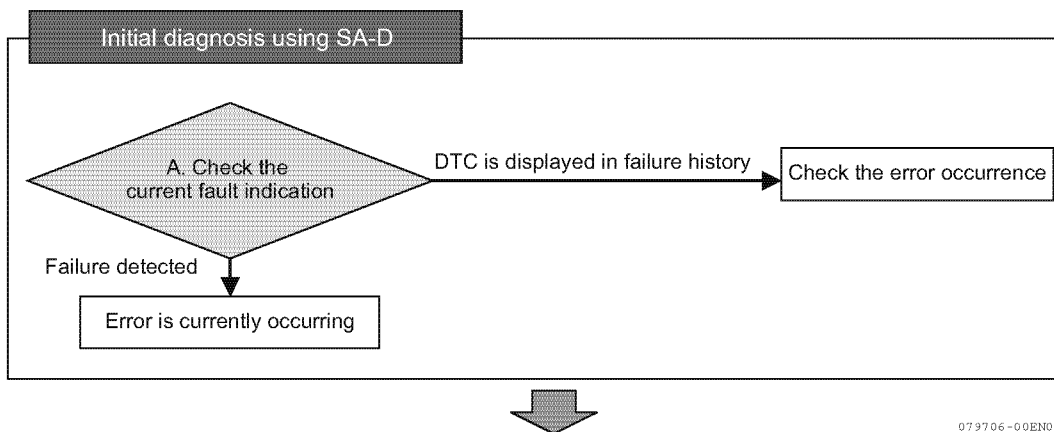

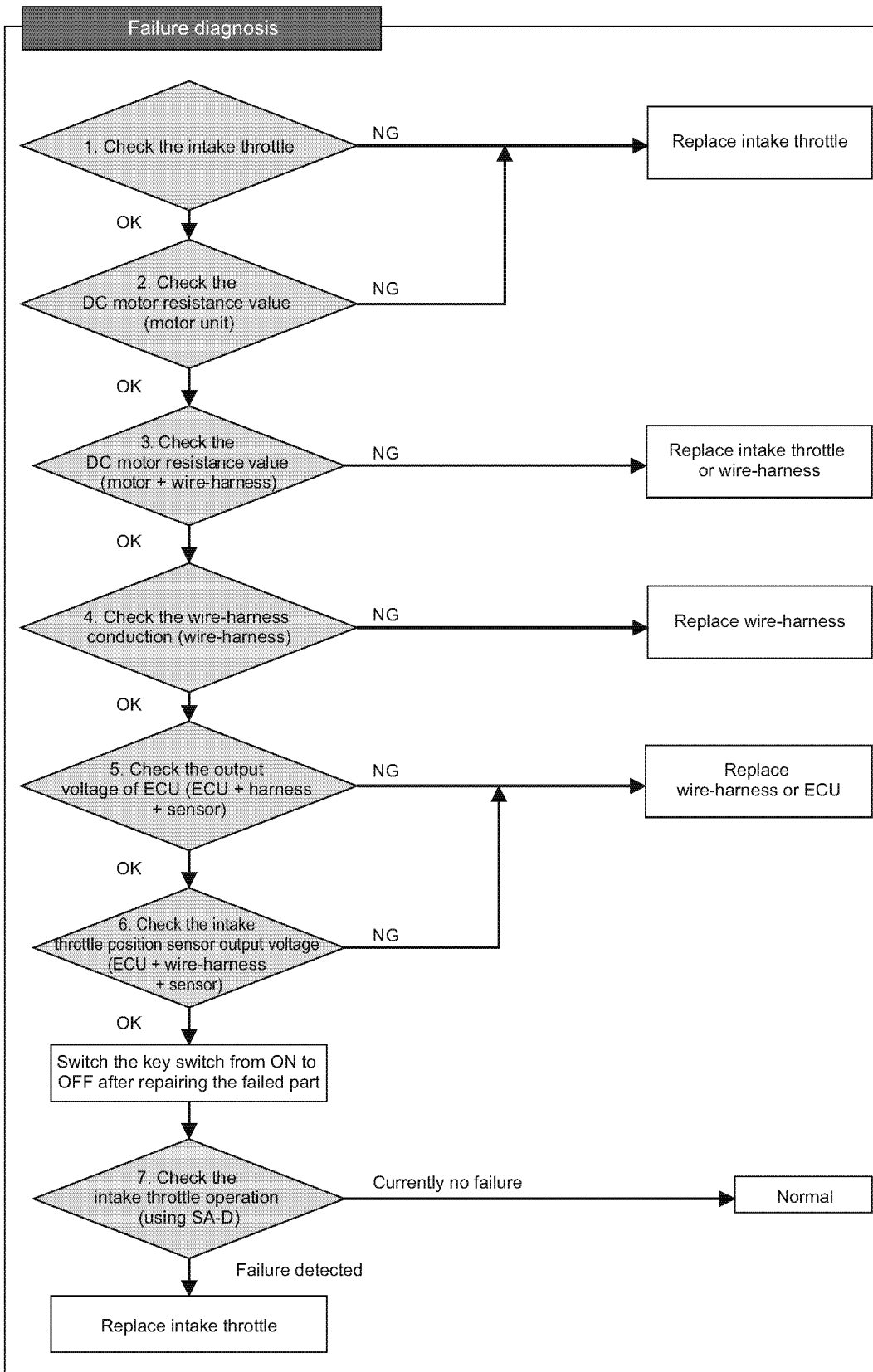

079777-00EN00

● Wire diagram

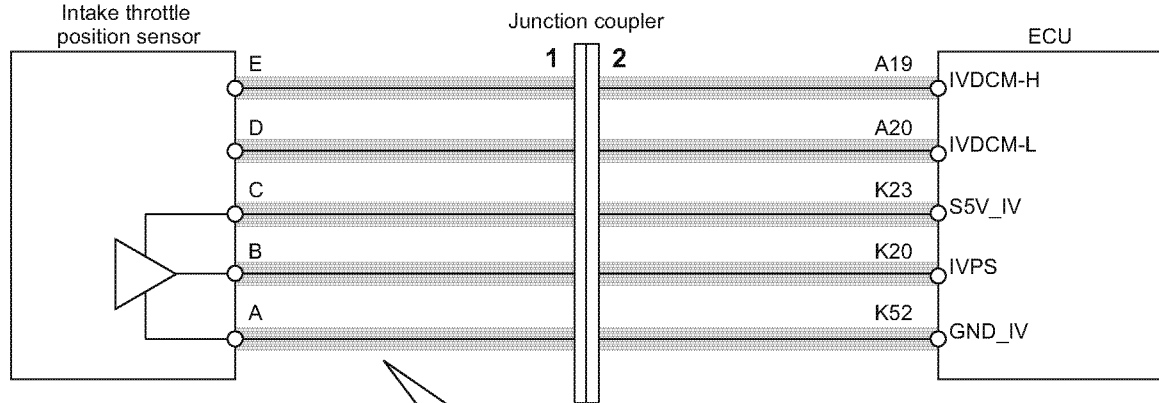

: Check points

Note: See P325 for the ECU pin layout.

050240-00E03

● **Work description**

1. Checking the intake throttle

- 1- Remove the intake throttle from the engine.
- 2- Make sure that the throttle valve is not bent or stuck.

NG	Replace the intake throttle
OK	Go to "Checking the DC motor resistance value (motor unit)"

2. Checking the DC motor resistance value (motor unit)

- 1- Remove the intake throttle from the wire-harness.
- 2- Using a circuit tester, measure the resistance value (overall resistance value) between intake throttle DC motor terminals A and B.

Reference: Overall resistance value of DC motor

The resistance value of DC motor is under investigation.	
--	--

NG	Replace the intake throttle
OK	Go to "Checking the resistance value (motor + wire-harness)"

3. Checking the resistance value (motor + wire-harness)

- 1- Connect the intake throttle and the wire-harness. Remove the ECU from the wire-harness.
- 2- Using a circuit tester, measure the resistance value between ECU wire-harness connectors A19 and A20.

Note: See the above "Reference: Overall resistance value of DC motor".

NG	<ul style="list-style-type: none"> • A coupler between the motor and the wire-harness may be defective. Replace the intake throttle • Replace the wire-harness.
OK	Go to "Checking the wire-harness conduction".

4. Checking the wire-harness conduction

- 1- Remove the wire-harness from the intake throttle and ECU. However, connect the junction coupler.
- 2- While referring to the P325 "ECU pin layout diagram", check the conduction of the wire-harness between terminals 1 and 2 in the chart below.

Reference: Intake throttle drive circuit conduction check pattern 1

Terminal 1 (Wire-harness connector on ECU side)	Terminal 2 (Wire-harness connector on ECU side)	Conduction	State
A19	VB/GND terminal	Yes	NG: Error
		No	OK: Normal
A20		Yes	NG: Error
		No	OK: Normal

Reference: Intake throttle drive circuit conduction check pattern 2

Terminal 1 (Wire-harness connector on ECU side)	Terminal 2 (Wire-harness connector on intake throttle side)	Conduction	State
A19	Motor terminal E	Yes	OK: Normal
		No	NG: Error
A20	Motor terminal D	Yes	OK: Normal
		No	NG: Error

NG	Wire-harness disconnection or short circuit. Replace the wire-harness.
OK	Go to "Checking the ECU output voltage".

5. Checking the ECU output voltage

- 1- Connect the checker harness between the ECU and engine wire-harness. Also, connect all connectors (sensor, wire-harness, ECU).
- 2- Using a circuit tester, measure the voltage between the intake throttle position sensors 5 V K23 and K52.

Voltage	State	Corrective action
$K23 < 4.375\text{ V}$	NG	<ul style="list-style-type: none"> • Replace the wire-harness. • Replace the ECU.
$4.375\text{ V} \leq K23 \leq 5.625\text{ V}$	OK (normal range)	Check the intake throttle position sensor output voltage.
$5.625\text{ V} < K23$	NG	<ul style="list-style-type: none"> • Replace the wire-harness. • Replace the ECU.

NG	Replace the wire-harness or ECU.
OK	Go to "Checking the intake throttle position sensor output voltage".

6. Checking the intake throttle position sensor output voltage

1-Connect the checker harness between the ECU and engine wire-harness. Also, connect all connectors (sensor, wire-harness, ECU).

2-Using a circuit tester, measure the voltage between the sensor signals K20 and K52.

Voltage	State	Corrective action
$K20 < 0.6 \text{ V}$	NG	<ul style="list-style-type: none"> • Replace the wire-harness. • Replace the ECU.
$0.6 \text{ V} \leq K20 \leq 4.4 \text{ V}$	OK (normal range)	Replace the ECU.
$4.4 \text{ V} < K20$	NG	<ul style="list-style-type: none"> • Replace the wire-harness. • Replace the ECU.

NG	Replace the wire-harness or ECU.
OK	Go to "Checking the intake throttle operation (using SA-D)"

7. Checking the intake throttle operation (using SA-D)

1-Turn off the key switch and turn on the key switch again.

2-Activate the intake throttle using "Active control of Diagnosis Test" of SMARTASSIST-Direct (SA-D), and check the current fault indication to see whether an error is detected.

No	Normal
Yes	Replace the intake throttle

■ EGR valve

● Related DTC

P code	SPN/FMI	Name
P0404	2791/0	EGR overvoltage error
P1404	2791/1	EGR low voltage error

● Workflow

Note: See "Work description" for work details. Go to "SA-D Operation Manual" for the SA-D operation.

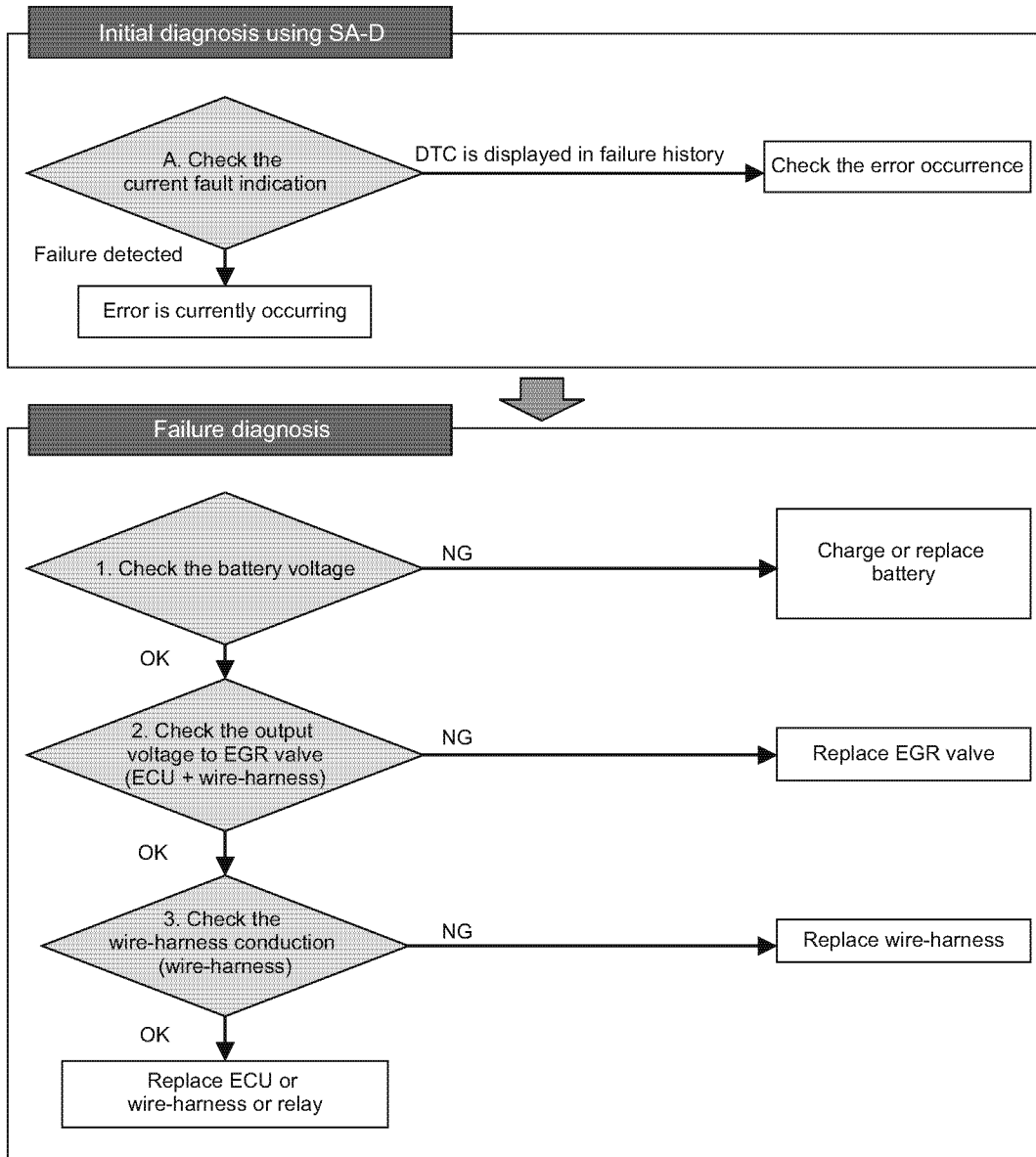

045809-02EN01

● Wiring diagram

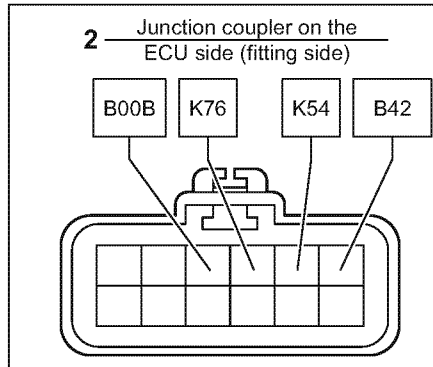
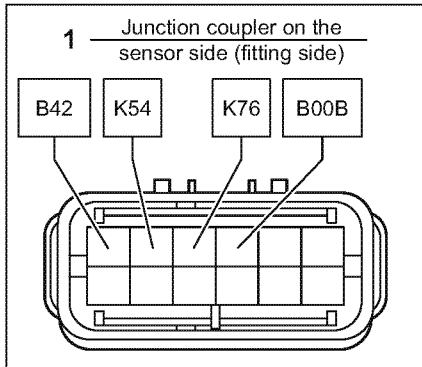
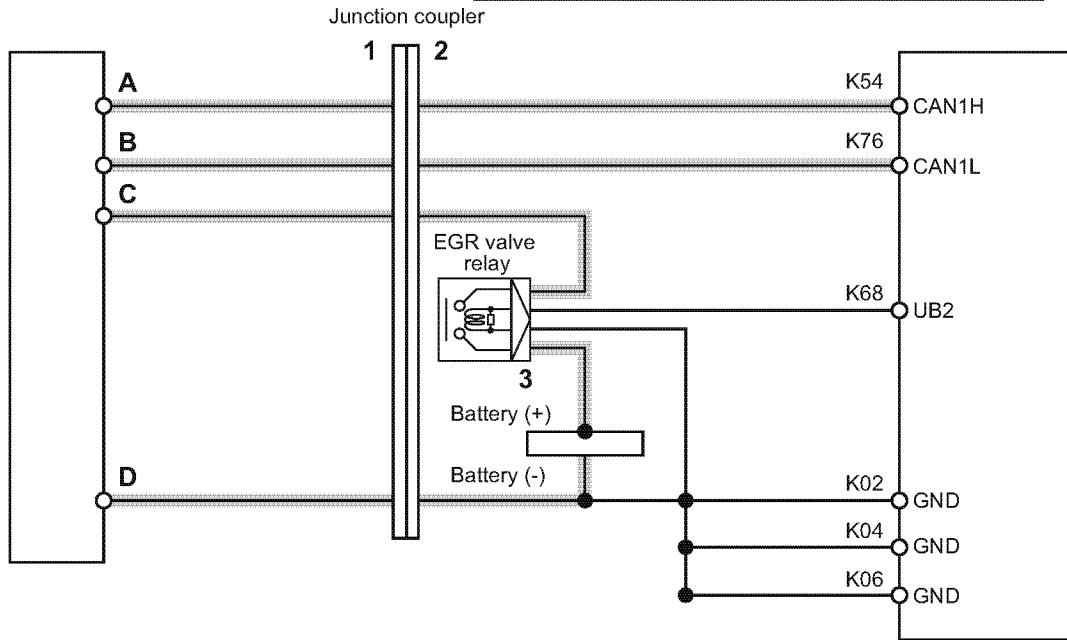
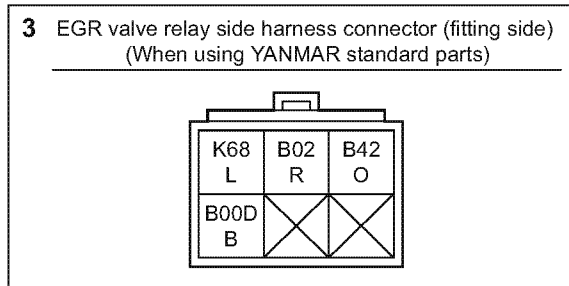
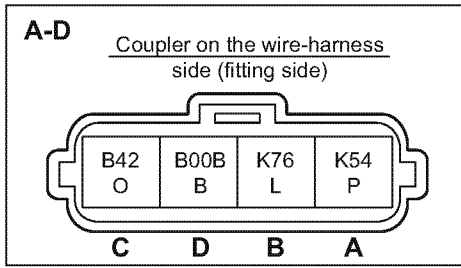

045810-00EN03

Note: See P325 for the ECU pin layout.

● **Work description**

1. Checking the battery voltage

Turn on the key switch and check the battery voltage.

- 1- Make sure that the battery voltage is not reduced due to the battery life.
- 2- Make sure that the battery output is not too high.

Reference: Battery voltage check pattern 1

Terminal 1 (Battery)	Terminal 2 (Battery)	Voltage	State
Battery (+)	Battery (-)	8 V or below	NG: Error
		8 V - 16 V	OK: Normal
		16 V or above	NG: Error

NG	Charge or replace the battery.
OK	Check the operation of other ECUs.

2. Checking the output voltage to the EGR valve

- 1- Remove the EGR valve from the wire-harness.
- 2- Turn on the key switch and check the battery voltage. Measure the wire-harness between C and D with reference to "Wire diagram".

Reference: Battery voltage check pattern 2

Terminal 1 (EGR valve side wire-harness connector)	Terminal 2 (EGR valve side wire-harness connector)	Voltage	State
C (B42)	D (B00B)	8 V or below	NG: Error
		8 V - 18 V	OK: Normal
		18 V or above	NG: Error

NG	Go to "Checking the wire-harness conduction".
OK	Replace the EGR valve.

3. Checking the wire-harness conduction

- 1- Remove the wire-harness from the EGR valve and the ECU. Also remove the EGR valve relay from the coupler.
- 2- While referring to the P325 "ECU pin layout diagram", check the conduction of the wire-harness between terminals 1 and 2 in the chart below.

Terminal 1 (Wire-harness connector on ECU side)	Terminal 2 (EGR valve side wire-harness connector)	Conduction	State
K01/K03/K05	EGR valve terminal C	Yes	OK: Normal
		No	NG: Error
K02/K04/K06	EGR valve terminal D	Yes	OK: Normal
		No	NG: Error
K54*1	EGR valve terminal A	Yes	OK: Normal
		No	NG: Error
K76*1	EGR valve terminal B	Yes	OK: Normal
		No	NG: Error

*1: Although it is not a battery line, the abnormal signal may be transmitted due to open circuit/short circuit. Check for precaution.

Reference: EGR valve conduction check pattern 1 (Checking the conduction of EGR valve power line)

Terminal 1 (EGR valve side wire-harness connector)	Terminal 2 (EGR valve relay side wire-harness connector)	Conduction	State
EGR valve terminal C	B42	Yes	OK: Normal
		No	NG: Error

Terminal 1 (EGR valve relay side wire-harness connector)	Terminal 2 (Battery)	Conduction	State
B02	Battery (+)	Yes	OK: Normal
		No	NG: Error

Terminal 1 (EGR valve side wire-harness connector)	Terminal 2 (Battery)	Conduction	State
EGR valve terminal D	Battery (-)	Yes	OK: Normal
		No	NG: Error

Terminal 1 (Wire-harness connector on ECU side)	Terminal 2 (Wire-harness connector on ECU side)	Conduction	State
K54*1	EGR valve terminal A	Yes	OK: Normal
		No	NG: Error
K76*1	EGR valve terminal B	Yes	OK: Normal
		No	NG: Error

*1: Although it is not a power line, the abnormal signal may be transmitted due to open circuit/short circuit. Check for precaution.

Reference: EGR valve conduction check pattern 2 (Check for short circuit)

Terminal 1 (EGR valve side wire-harness connector)	Terminal 2 (Wire-harness connector ECU side)	Conduction	State
EGR valve terminal C	All terminals other than the below: K01, K03, K05	Yes	NG: Error
		No	OK: Normal
EGR valve terminal D	All terminals other than GND	Yes	NG: Error
		No	OK: Normal
EGR valve terminal A*1	All terminals other than K54	Yes	NG: Error
		No	OK: Normal
EGR valve terminal B*1	All terminals other than K76	Yes	NG: Error
		No	OK: Normal

*1: Although it is not a battery line, the abnormal signal may be transmitted due to open circuit/short circuit. Check for precaution.

NG	Wire-harness disconnection or short circuit. Replace the wire-harness.
OK	<ul style="list-style-type: none"> The coupler between the ECU and the wire-harness may be defective. Replace the wire-harness. Possibly an EGR valve relay error. Replace the EGR valve relay. Replace the ECU.

■ EGR valve

● Related DTC

P code	SPN/FMI	Name
P0403	2791/12	Disconnection in EGR motor coils
P1405	522579/12	Short circuit in EGR motor coils
P0488	522580/12	EGR position sensor error
P1409	2791/7	EGR feedback error
P148A	522581/7	EGR valve sticking error
P049D	522582/7	EGR initialization error
U0401	2791/9	EGR ECM data error
U1401	522617/12	EGR target value out of range
P1410	522583/1	EGR high temperature thermistor error
P1411	522584/1	EGR low temperature thermistor error

● Workflow

Note: See "Work description" for work details. Go to "SA-D Operation Manual" for the SA-D operation.

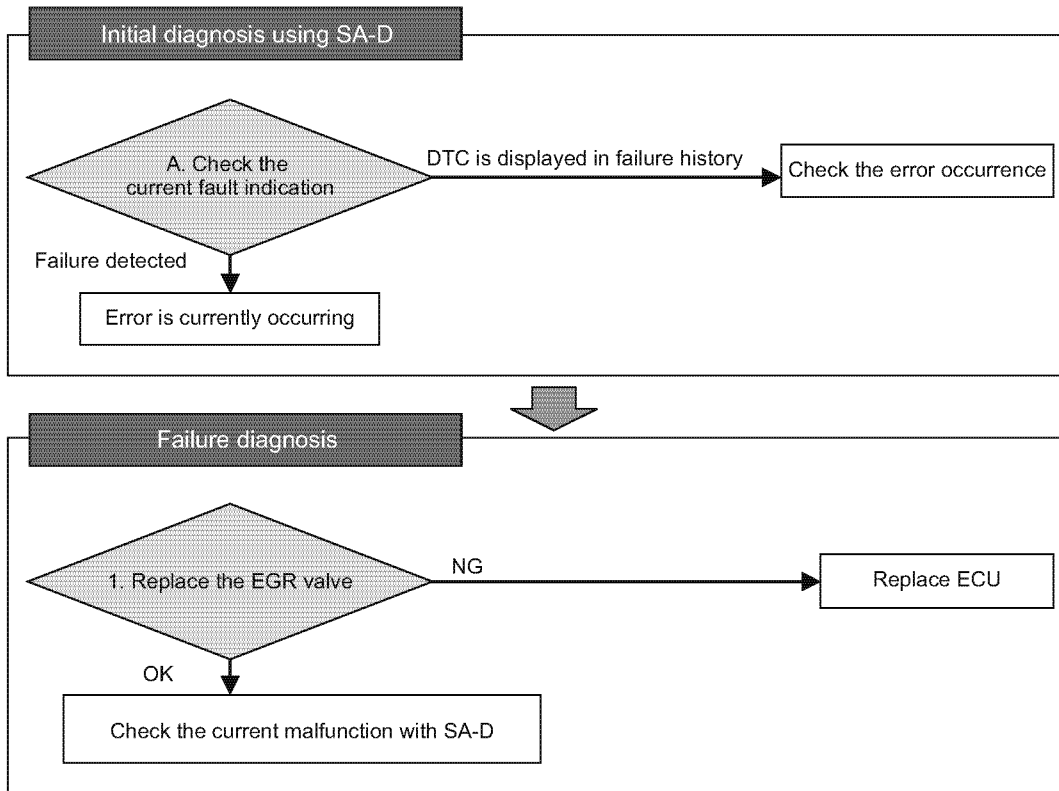

050234-01EN01

● Work description

1. Replacing the EGR valve

EGR valve internal circuit may be defective.

Replace the EGR valve.

NG	Replace the ECU.
OK	Checking the current failure with SA-D.

Communication related

■ CAN 1

● Related DTC

P code	SPN/FMI	Name
U010B	522610/9	CAN 1 (for EGR): Reception time out
U1107	522611/9	CAN 1 (for exhaust throttle): Reception time out

● Workflow

Note: See "Work description" for work details. Go to "SA-D Operation Manual" for the SA-D operation.

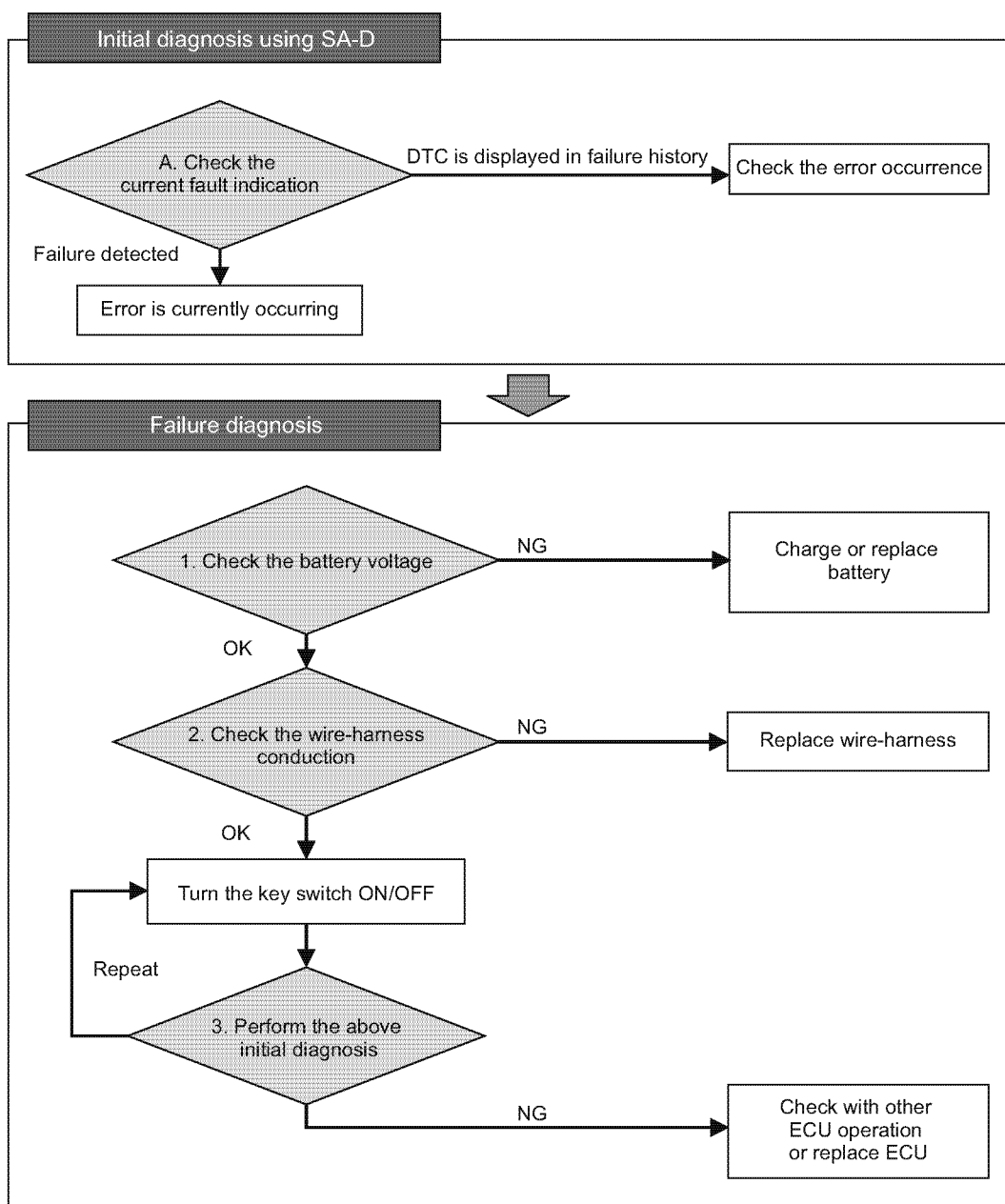

04E712-00EN02

● Wiring diagram

Exhaust throttle (only when option is selected)

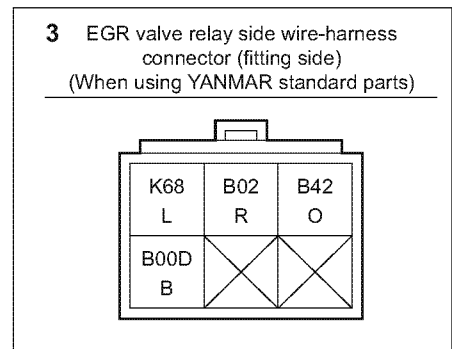
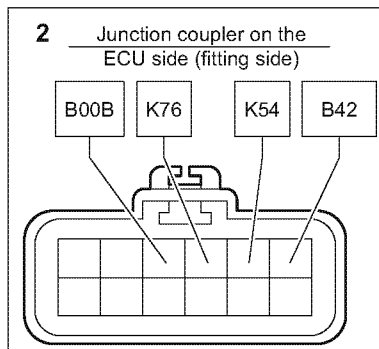
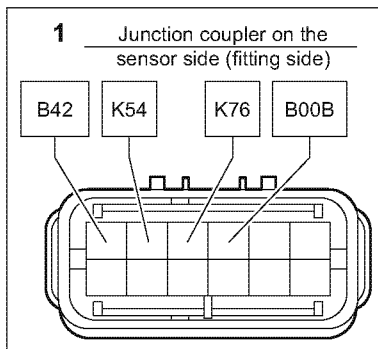
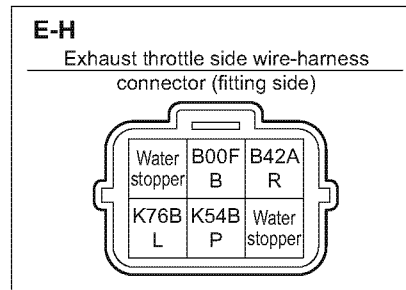
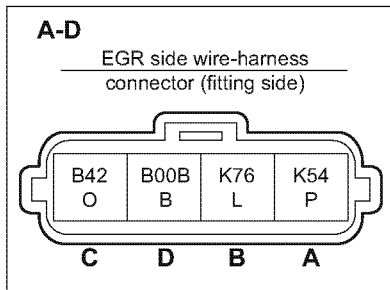
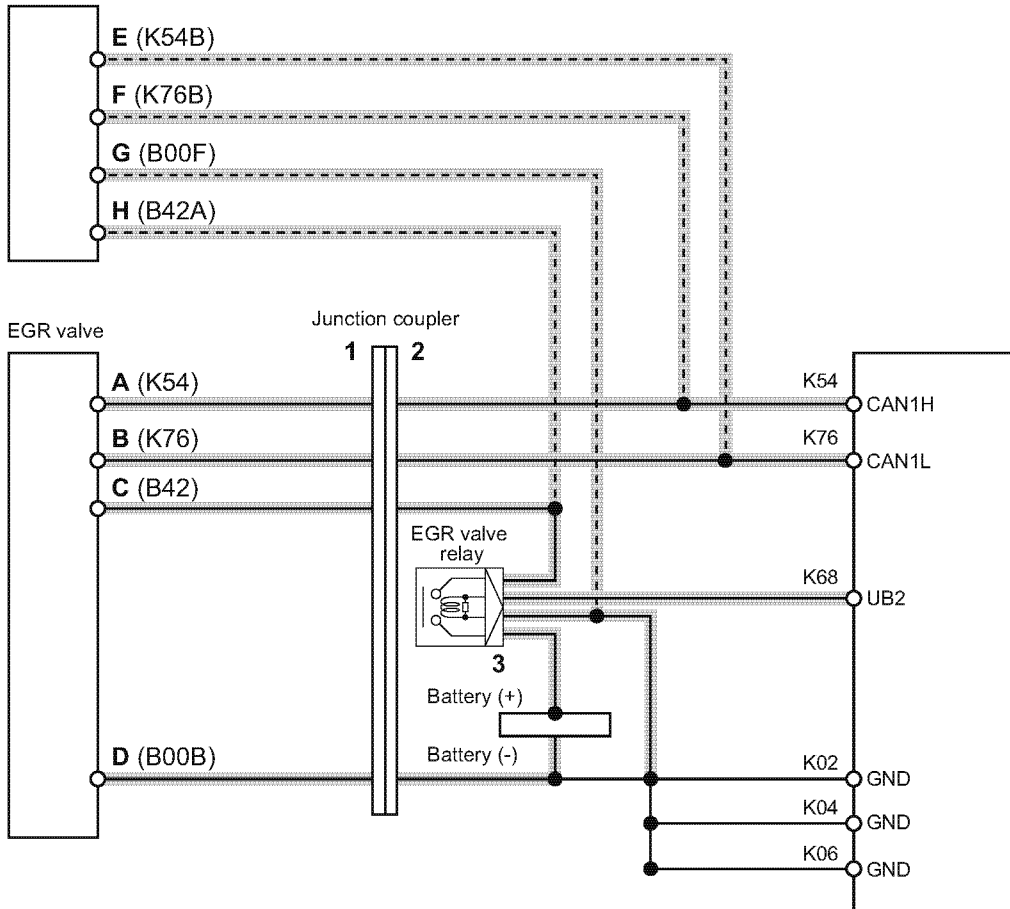

: Check points

077789-00EN00

Note: See P325 for the ECU pin layout.

● **Work description**

1. Checking the battery voltage

Turn on the key switch and check the battery voltage.

- 1- Make sure that the battery voltage is not reduced due to the battery life.
- 2- Make sure that the battery output is not too high.

NG	Charge or replace the battery.
OK	Go to "Checking the wire-harness conduction".

2. Checking the wire-harness conduction

- 1- Remove the wire-harness from the ECU and ECU of driven machine side.
- 2- While referring to P325 "ECU pin layout diagram", check the wire-harness conduction for the error-detected actuator (EGR valve or exhaust throttle) between terminal 1 and terminal 2 using the table below.

Reference: CAN 1 line conduction check pattern 1

Terminal 1 (Wire-harness connector on ECU side)	Terminal 2 (Actuator side wire-harness connector)	Conduction	State
K54	K54	Yes	OK: Normal
		No	NG: Error
K76	K76	Yes	OK: Normal
		No	NG: Error

Reference: CAN 1 line conduction check pattern 2

Terminal 1 (Wire-harness connector on ECU side)	Terminal 2 (Wire-harness connector on ECU side)	Conduction	State
K54	All terminals other than K54 and K76	Yes	NG: Error
		No	OK: Normal
K76	All terminals other than K54 and K76	Yes	NG: Error
		No	OK: Normal

NG	Wire-harness disconnection or short circuit. Replace the wire-harness.
OK	Go to "Operation using SA-D".

3. Operation using SA-D

- 1- Turn off the key switch, turn on the key switch again, and start the engine.
- 2- Connect the SA-D and check the current fault indication to see whether an error is detected.

No	Normal
Applied	<ul style="list-style-type: none"> • Check the actuator operation. <ul style="list-style-type: none"> 1. Check the power supply to the actuator. 2. If there is no power supply, check the EGR valve relay, fuse, and power line connection. 3. If there is nothing wrong with the power system, replace the actuator that detected communication error. • Replace the ECU.

■ CAN 2

● Related DTC

P code	SPN/FMI	Name
U0292	522596/9	TSC1 (SA1) reception timeout
U1301	522597/9	TSC1 (SA2) reception timeout
U1292	522599/9	Y_ECR1 reception timeout
U1293	522600/9	Y_EC reception timeout
U1294	522601/9	Y_RSS reception timeout
U0168	237/31	VI reception timeout
U3002	237/13	VI reception data error
U1300	522609/9	Y_ETCP1 reception time out
U1303	522619/9	Y_DPFIF reception timeout
U1302	522681/9	EBC1 reception timeout
U0167	522730/12	Immobilizer error (CAN communication)

● Workflow

Note: See "Work description" for work details. Go to "SA-D Operation Manual" for the SA-D operation.

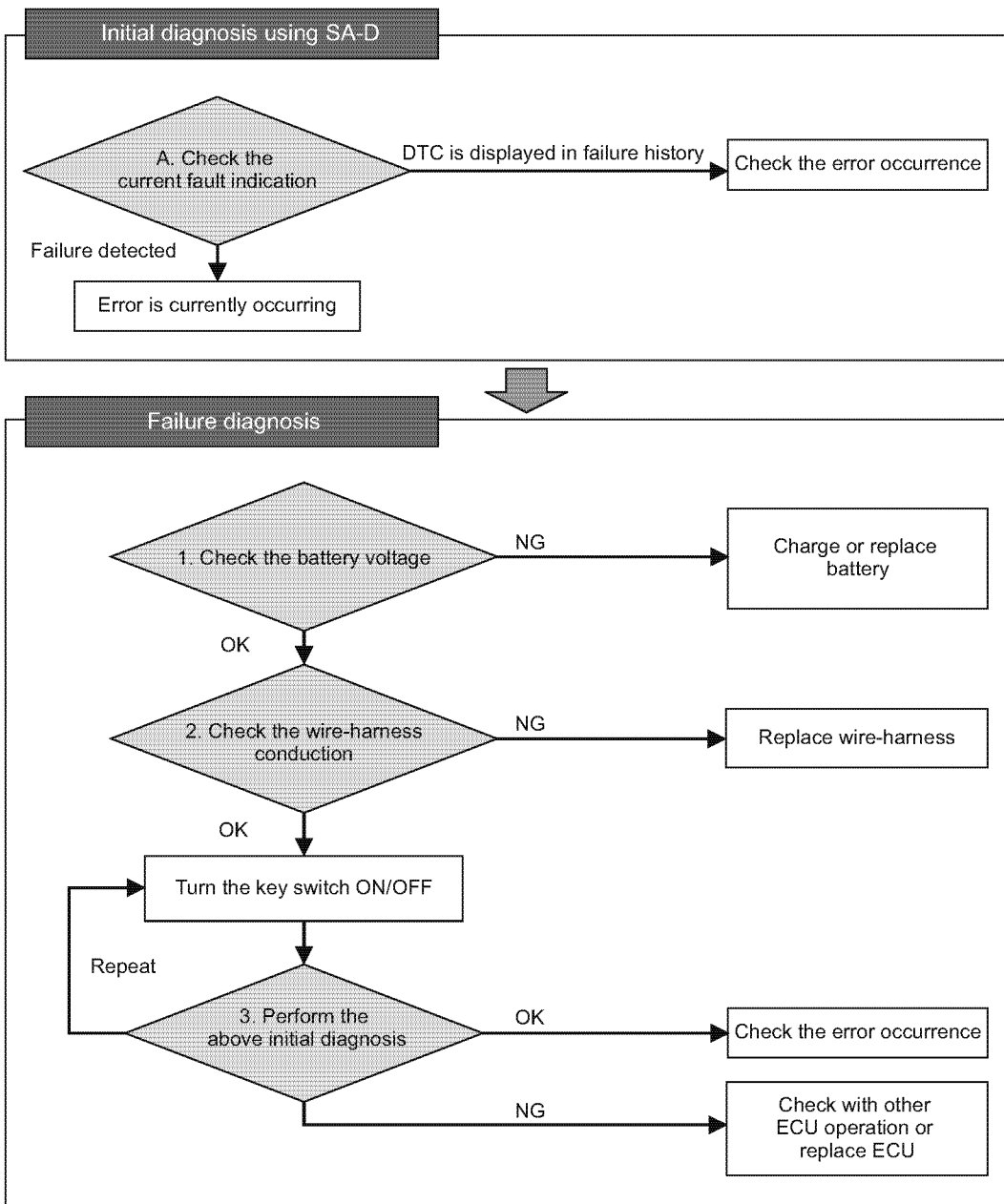

045712-01EN03

● Wiring diagram

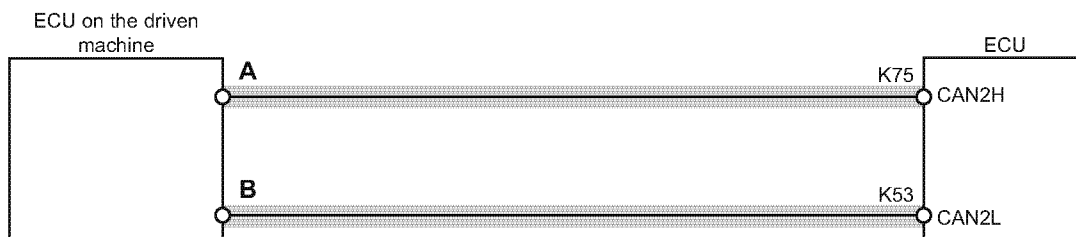

045714-00EN00

Note: See P325 for the ECU pin layout.

● **Work description**

1. Checking the battery voltage

Turn on the key switch and check the battery voltage.

- 1- Make sure that the battery voltage is not reduced due to the battery life.
- 2- Make sure that the battery output is not too high.

NG	Charge or replace the battery.
OK	Go to: "Checking the wire-harness conduction".

2. Checking the wire-harness conduction

- 1- Remove the wire-harness from the ECU and ECU of driven machine side.
- 2- While referring to the P325 "ECU pin layout diagram", check the conduction of the wire-harness between terminals 1 and 2 in the chart below.

Reference: CAN 2 line conduction check pattern 1

Terminal 1 (Wire-harness connector on ECU side)	Terminal 2 (Wire-harness connector on driven machine ECU side)	Conduction	State
K75	Driven machine ECU terminal A	Yes	OK: Normal
		No	NG: Error
K53	Driven machine ECU terminal B	Yes	OK: Normal
		No	NG: Error

Reference: CAN 2 line conduction check pattern 2

Terminal 1 (Wire-harness connector on ECU side)	Terminal 2 (Wire-harness connector ECU side)	Conduction	State
K75	All terminals other than K75	Yes	NG: Error
		No	OK: Normal
K53	All terminals other than K53	Yes	NG: Error
		No	OK: Normal

NG	Wire-harness disconnection or short circuit. Replace the wire-harness.
OK	Go to "Operation using SA-D".

3. Operation using SA-D

- 1- Turn off the key switch, turn on the key switch again, and start the engine.
- 2- Connect the SA-D and check the current fault indication to see whether an error is detected.

No	Normal
Applied	<ul style="list-style-type: none"> • Check the operation of other ECUs. • Replace the ECU.

ECU related

● Related DTC

P code	SPN/FMI	Name
P0601	630/12	EEPROM memory deletion error
P160E	630/12	EEPROM memory reading error
P160F	630/12	EEPROM memory writing error
P2229	108/3	Atmospheric pressure sensor error (voltage high)
P2228	108/4	Atmospheric pressure sensor error (voltage low)
P2226	108/12	Atmospheric pressure sensor error (Digital IC error)
P1231	108/10	Atmospheric pressure sensor error (characteristic error)
P1613	522585/12	CY146 SPI communication fault
P1608	522588/12	Excessive voltage of supply 1
P1617	522589/12	Insufficient voltage of supply 1
P1469	523473/12	AD converter fault 1
P1470	523474/12	AD converter fault 2
P1471	523475/12	External monitoring IC and CPU fault 1
P1472	523476/12	External monitoring IC and CPU fault 2
P1031	518468/12	Shutoff 1 due to ECU internal abnormality
P1032	518469/12	Shutoff 2 due to ECU internal abnormality
P1033	518470/12	Shutoff 3 due to ECU internal abnormality
P1034	518471/12	Shutoff 4 due to ECU internal abnormality
P1473	523477/12	ROM fault
P1474	523478/12	Shutoff path fault 1
P1475	523479/12	Shutoff path fault 2
P1476	523480/12	Shutoff path fault 3
P1477	523481/12	Shutoff path fault 4
P1478	523482/12	Shutoff path fault 5
P1479	523483/12	Shutoff path fault 6
P1480	523484/12	Shutoff path fault 7
P1481	523485/12	Shutoff path fault 8
P1482	523486/12	Shutoff path fault 9
P1483	523487/12	Shutoff path fault 10
P1035	518472/12	Shut-off path abnormality by external monitoring IC and CPU

● Workflow

Note: See "Work description" for work details. Go to "SA-D Operation Manual" for the SA-D operation.

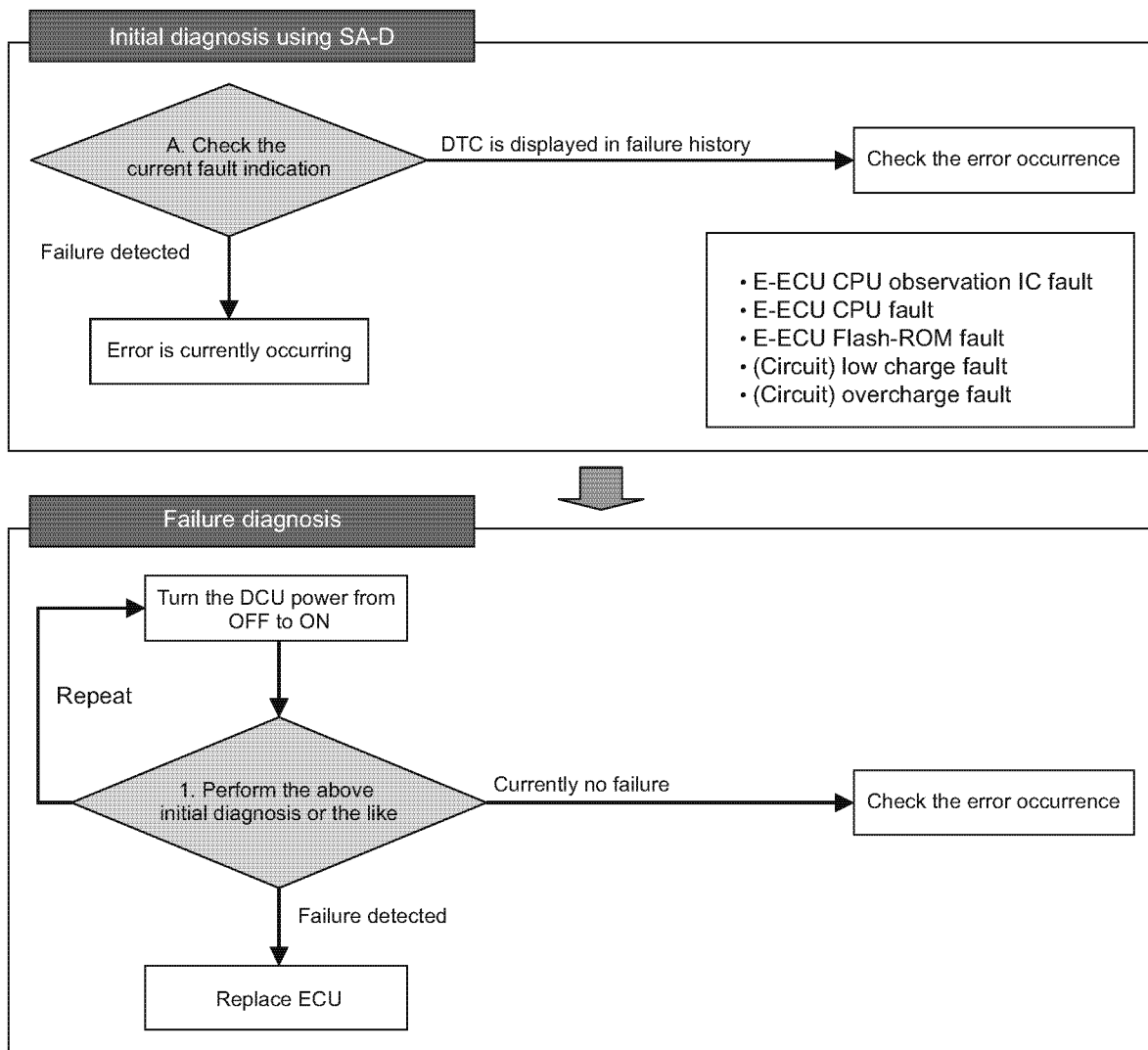

044395-01EN01

● Work description

1. Checking the current failure with SA-D

- 1-Turn off the ECU power and turn on the key switch again.
- 2-Connect the SA-D and check the current fault indication to see whether an error is detected.

No	When an error has been logged in the Logged Diagnostic Trouble Code, check for error occurrences.
Yes	<ul style="list-style-type: none"> • Switch the ECU power from ON to OFF again and perform the work indicated above 1. • Replace the ECU.

Others

■ Overspeed

● Related DTC

P code	SPN/FMI	Name
P0219	190/0	Overspeed

● Workflow

Note: For the details of work, refer to the following <Work description>. For the operation method of the diagnosis, refer to the separate "SMARTASSIST-DIRECT (SA-D) operation manual".

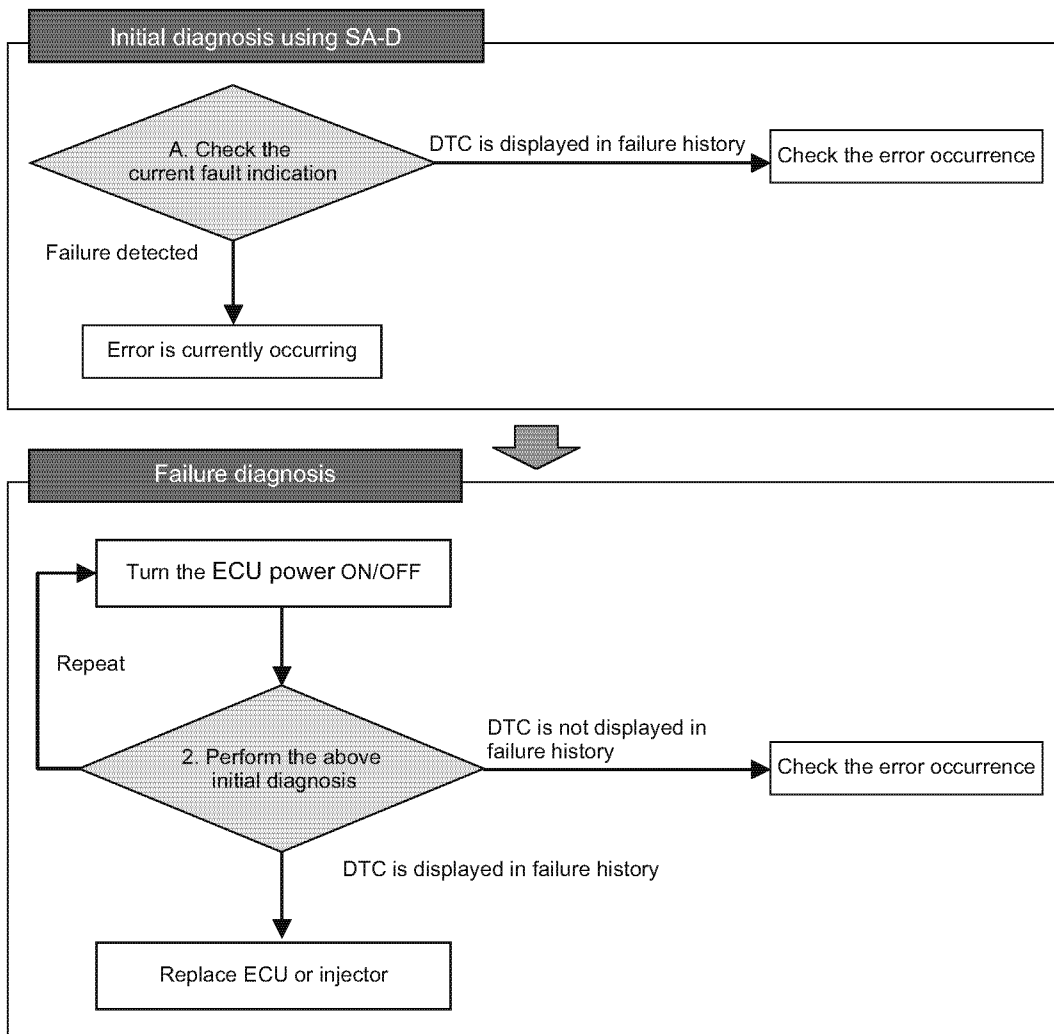

044396-01EN01

● Work description

1. Operation using SA-D

1- Turn off the ECU power, turn on the key switch again, and start the engine.

2- Connect the SA-D and check the current fault indication to see whether an error is detected.

No	When an error has been logged in the Logged Diagnostic Trouble Code, check for error occurrences.
Yes	<ul style="list-style-type: none">• Switch the ECU power from ON to OFF again and perform the work indicated above 1.• Replace the ECU or injector.

YANMAR

Head Office:
YANMAR POWER TECHNOLOGY CO., LTD.
1-32 Chayamachi, Kita-ku, Osaka, Japan
<https://www.yanmar.com>

Yanmar America Corporation
101 International Parkway
Adairsville, GA 30103, U.S.A.
TEL: +1-770-877-9894 FAX: +1-770-877-9009
<https://www.yanmar.com/us/>

Yanmar Europe B.V.
Brugplein11, 1332 BS Almere -de Vaart
The Netherlands.
TEL: +31-36-5493200 FAX: +31-36-5493209
<https://www.yanmar.com/eu/>

Yanmar Asia (Singapore) Corporation Pte Ltd.
4 Tuas Lane, Singapore 638613
TEL: +65-6861-3855 FAX: +65-6862-5189
<https://www.yanmar.com/sg/>

Yanmar Engine (Shanghai) Corporation Ltd.
Room 1101-1106, No.757 Mengzi Road,
Huangpu District, Shanghai 200023 PRC
TEL: +86-21-2312-0688 FAX: +86-21-6880-8090
<http://www.yanmar-china.com/cn/>

Yanmar South America Industria De Maquinas Ltda.
Av. Presidente Vargas 1400, Indaiatuba, S.P., Brazil, CEP: 13338-901
TEL: +55-19-3801-9224 FAX: +55-19-3875-3899, 2241
<https://www.yanmar.com/br/>

As of April 1, 2020

TROUBLESHOOTING MANUAL

3TNV88C, 3TNV86CT, 4TNV88C, 4TNV86CT, 4TNV98C, 4TNV98CT,
3TN88C, 3TN86CT, 4TN88C, 4TN86CT, 4TN98C, 4TN98CT

1st edition: February 2019
1st edition 1st rev.: January 2022
2nd edition: February 2023
3rd edition: March 2023

Issued by: YANMAR POWER TECHNOLOGY CO., LTD.
Edited by: YANMAR GLOBAL CS CO., LTD.



YANMAR POWER TECHNOLOGY CO., LTD.

<https://www.yanmar.com>

ODTN5-EN1023
Mar.2023-0
PRINTED IN JAPAN