



Supplement to Yanmar Kit Installation Instructions

SAFETY

This product is designed and intended only for use with a YANMAR engine. All safety and warning information contained in the Yanmar Operation Manual and Service Manual is adopted and incorporated to apply to the components, accessories, and parts that are utilized with Yanmar engines. Follow all instructions and precautions before installing this product, before operating, during operation, and during periodic maintenance procedures for your safety, the safety of others, and to protect the performance of your engine.

Kit Name: KAC8



Item	Lev.	O	Part No.	Description	Quantity	Remarks
1 to 11	-		729689-12130	Air Cleaner Kit	1	
1	--		129687-12500*	Air Cleaner assy	1	
2	---		129687-12510*	Element, a/c	1	
3	--		129687-12570*	Band, Air Cleaner	1	
4	--		129689-12610*	Bracket	1	
5	--		26106-080162*	Bolt, M8 X 1.25 - 16, (Flanged hex head)	4	
6	--		26106-080202*	Bolt, M8 X 1.25 - 20, (Flanged hex head)	2	
7	--		26366-080002*	Nut, M8 X 1.25, (Flange)	2	
8	--		129689-12220*	Hose	1	
9	--		23000-070000*	Clamp 70, hose	1	
10	--		23000-080000*	Clamp 80, hose	1	
11	--		129687-12600*	Rain cap assy	1	

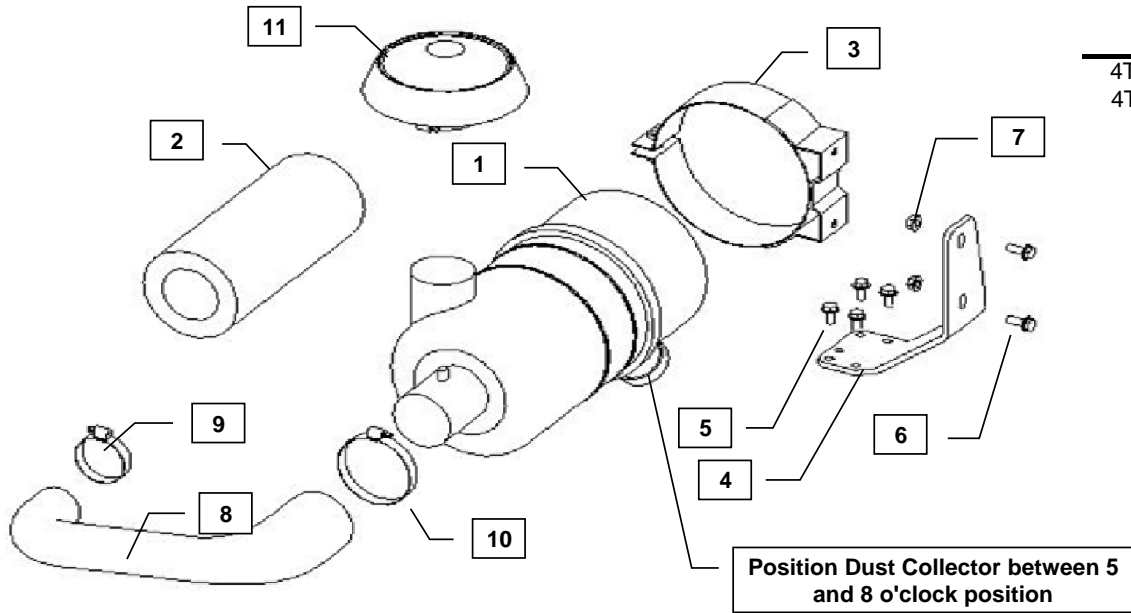

Note: Service parts are denoted by an asterisk. To replace non-service parts, the entire kit will need to be purchased.

Remarks: Kit includes Donaldson part number label.



Installation Instructions

Hand tighten all bolts and nuts until assembly is completed, then torque according to specifications in Table 1. The numbers in () represent the item numbers.

1. Fasten the Air Cleaner Band (3) on to the Air Cleaner Bracket (4) using M8 x 1.25 - 20 bolts (6) and M8 Flange Nuts (7).
2. Assemble Air Cleaner Band (3) and Bracket (4) assembly to the Intake Manifold with M8 x 1.25 - 16 bolts (5)
3. Open the Air Cleaner Band (3) by removing the bolt and spring fastener from the assembly. Remove the Air Cleaner Cover and Element (2) from the Air Cleaner (1). This will allow the Air Cleaner (1) to slide into the Air Cleaner Band (3).
4. Insert the Air Cleaner (1) in the Band (3) and position in the recess provided on the Air Cleaner. Fasten it with the bolt and spring that came with the Band. Reinstall the Air Cleaner Cover and adjust the orientation so the dust collector is positioned downward, between the 5 and the 8 o'clock position.
5. Fasten the small end of the Air Cleaner Hose (8) to the turbocharger inlet using Band Clamp (9). Fasten the large diameter end of the Hose to the Air Cleaner (1) using Band Clamp (10).
6. Fasten the Rain Cap (11) to the inlet of Air Cleaner (1) using the clamp that comes with the Rain Cap.
7. Install the included Air Cleaner Label on the Air Cleaner (1) or a piece of equipment in the area of the Air Cleaner. Be sure Label is visible and is not placed on the Cleaner Cover.

NOTE: Comply with torque standards in the table to avoid unexpected damage during installation or in the future.

Table 1: Tightening Torque

Diameter x Pitch	Kgf-m	Foot-lbf	N-m
M8 x 1.25	1.5 ~ 2.9	10.6 ~ 20.9	14.4 ~ 28.3